

**LANDA®**



# COMPLETE CATALOG

Commercial Pressure Washers,  
Genuine Landa Parts, Pressure Washer Parts,  
Accessories & Detergents

**50  
YEAR**

**ANNIVERSARY**

1969 - 2019



## Meeting Your Cleaning Needs

Industrial cleaning is a daily chore for some and is crucial in helping to maintain the efficiency and dependability of heavy machinery and equipment. To that end, Landa offers a long line of industrial cleaning products that meet the most stringent cleaning needs of just about any industrial equipment user.

Not sure which pressure washer is right for you? No problem! Landa has knowledgeable and experienced dealers throughout the country who can help you find the right product for your job.

Visit [www.landa.com](http://www.landa.com) today to find the right machine for you.



## Look for Landa's Value-Added Icons

Throughout the following pages, look for these icons displayed with each Landa pressure washing system. Find out what makes our professional cleaning equipment some of the most unique and sought after equipment in the industry.



### HOT WATER SYSTEM

Landa's hot water pressure washers are your solution for cleaning greasy spills and grimy surfaces.



### COLD WATER SYSTEM

Landa's cold water pressure washers help you remove caked on dirt and other debris from surfaces.



### 7-YEAR PUMP WARRANTY

Most Landa pumps come with a 7-year pump warranty, wear parts excluded.



### QUICK SHIP

Models marked with the Quick Ship logo are in stock and ship and ready to ship immediately.



### AUTO START/STOP

Protects during unattended operation by shutting down the pump during non-use. Optional on some series.



### TRU-TITE SYSTEM

Uses a spring-loaded idler arm to keep the belt aligned and tensioned, creating less wear and tear on the belt.



### COOL-BYPASS\*\*

Circulates water to prevent overheating the pump or contaminating the detergent in the water tank.



### EASY!LOCK

A robust, long-life quick-release fastener: 5 times faster than screw connections.



### WIRELESS REMOTE

Controls pump, burner, and detergent remotely from up to 300' away.



### TRU-TRAC TECHNOLOGY

Keeps the belt parallel with the pump and motor when adjusting the belt tension.



### HOT WATER GENERATORS

Economically add hot water cleaning to a pressure washer.



### WATER RECOVERY

Recover wash water and contain for transfer



### EASY!FORCE TRIGGER GUN

Uses recoil force to hold the trigger for you – zero holding force for effortless operation.



## TABLE OF CONTENTS

---

■ LANDA PRESSURE WASHERS	2
■ FLOOR CARE	36
■ LANDA DETERGENTS	72
■ LANDA BRANDED PARTS	81
■ GUNS & LANCES	103
■ HOSE & HOSE REELS	111
■ COUPLERS, FITTINGS & FILTERS	123
■ NOZZLES	138
■ PUMPS & PUMP KITS	151
■ UNLOADERS, INJECTORS, VALVES & GUAGES	177
■ ENGINES, MOTORS & PULLEYS	197
■ BURNERS	203
■ ELECTRICAL COMPONENTS	214
■ CHASSIS COMPONENTS	227
■ PRESSURE WASHER ACCESSORIES	229
■ CAR WASH BAY ACCESSORIES	240
■ PARTS WASHER PARTS	247
■ AG SPRAY ACCESSORIES	251
■ CARPET & RESTORATION	257
■ APPENDIX	274
■ INDEX	278



# PHW





## Hot Water > Electric Powered > Diesel/Oil Heated

This workhorse has been a flagship for more than a quarter of a century, and now has patented Cool-Bypass\* technology that limits temperature buildup in the pump during periods of inactivity, prolonging the life of the equipment. Another innovation introduced to an already long list of features is Snap 'N Go kits, which allow easy upgrades to time delay shutdown, wireless remote operation, or auto start-stop. This industrial series includes our large frame LT Pump affixed to our proprietary Tru-Trac belt tension system, and an oversized 10-gallon diesel fuel capacity allows you to complete challenging cleaning jobs without interruption. The integrated float tank and metering valve allows for the easy introduction of detergents when needed. Whether cleaning hog confinements, farm equipment, or fleet vehicles, the PHW series is built to deliver top quality results.



- Belt-Drive Landa Pump with 7-year warranty
- Patented Cool-Bypass\*
- 13" Flat-Free Tires
- Industrial-strength electric motor with multiple voltage options
- Many options: Time Delay, Auto Start/Stop, LanCom wireless remote control
- EASY!Force Trigger gun – zero effort required

\*Patent US 8,496,188 B2

Model #	Part #	GPM	PSI	Pump RPM	Pump	Motor HP	Volts	Phase	Amps	Ship Wt (lbs)
PHW3-11024D	1.109-078.0	2.8	1000	1725	LB3030R	2.0	120	1	20	590
 PHW4-22024A	1.109-079.0	4.0	2200	1025	LT6036R.2	6.2	230	1	29	625
PHW4-22024B	1.109-080.0	4.0	2200	1025	LT6036R.2	6.2	230	3	19	610
PHW4-22024C	1.109-081.0	4.0	2200	1025	LT6036R.2	6.2	460	3	11	615
PHW4-22024F	1.109-082.0	3.5	2200	940	LT6036R.2	5.0	575	3	10	615
PHW4-22024G	1.109-083.0	4.0	2200	1025	LT6036R.2	6.2	208	1	31	625
PHW4-22024H	1.109-084.0	4.0	2200	1025	LT6036R.2	6.2	208	3	21	610
 PHW4-30024A	1.109-085.0	3.9	3000	975	LT6036R.2	8.2	230	1	38	640
PHW4-30024B	1.109-086.0	3.9	3000	975	LT6036R.2	8.2	230	3	24	625
PHW4-30024C	1.109-087.0	3.9	3000	975	LT6036R.2	8.2	460	3	12	635
PHW4-30024F	1.109-088.0	3.5	3000	975	LT6036R.2	7.5	575	3	12	635
PHW4-30024G	1.109-089.0	3.9	3000	975	LT6036R.2	8.2	208	1	40	640
PHW4-30024H	1.109-090.0	3.9	3000	975	LT6036R.2	8.2	208	3	26	625
PHW5-30024B	1.109-091.0	4.8	3000	1500	LT6036R.2	10.0	230	3	30	625
PHW5-30024C	1.109-092.0	4.8	3000	1500	LT6036R.2	10.0	460	3	16	635

Dimensions: 52"L x 32"W x 38"H

### Field Installed Options & Accessories

- 8.917-509.0 LanCom Wireless Remote Control Kit
- 8.725-709.0 Additional LanCom Remote
- 8.917-817.0 LanCom Wall Mount Bracket
- 8.917-507.0 Snap-N-Go Auto Start/Stop Kit
- 8.917-508.0 Snap-N-Go Time Delay Kit
- 8.750-487.0 Pivot Hose Reel (100' capacity, reel only)
- 8.750-477.0 Non-Pivot Hose Reel (100' capacity, reel only)

### Field Installed Options & Accessories

- 8.917-798.0 Wheel Kit (2 casters)
- 8.754-435.0 13" Flat-Free Tire (qty 1)
- 8.917-683.0 Steam Combo Kit
- 8.917-714.0 Lifting Bracket/Hose Reel Platform Only
- 8.917-713.0 Lifting Bracket/Hose Reel Platform with E-Zee Reel & Plumbing (holds 100' of 3/8" hose, not included)





# HOT



**Hot Water > Electric Powered > Diesel/Oil Heated**

Simple and affordable with efficient and reliable high-pressure hot water, this series is designed for ease of operation as well as portability. Don't let the simplicity fool you because this series includes all the rugged components you've come to expect in Landa products, including a diesel burner matched up with our long lasting Dura-Coil. Match the HOT performance and quality specifications up against any of our rivals, and you will quickly discover the value is undeniable!



- Belt-Drive and Direct-Drive Pumps with 7-year warranty
- Burner mounted on the end for easy access; industrial-strength motor
- 13" Flat-Free Tires
- Optional hose reel platform
- Optional caster wheel kit for easy maneuverability
- EASY!Force Trigger gun — zero effort required

Model #	Part #	GPM	PSI	Pump	Pump RPM	Pump	Motor HP	Volts	Phase	Amps	Ship Wt (lbs)
HOT2-11024D	1.109-095.0	2.0	1000	Direct	1725	LF2030S	1.5	120	1	18	516
HOT2-15024D	1.109-096.0	1.9	1500	Direct	1725	LF2030S	2.0	120	1	20	529
HOT3-11024D	1.109-097.0	2.8	1000	Direct	1725	LF2830S	2.0	120	1	20	530
HOT4-20024A	1.109-098.0	3.5	2000	Belt	1350	LB4025R	5.0	230	1	25	561
HOT4-20024G	1.109-099.0	3.5	2000	Belt	1350	LB4025R	5.0	208	1	27	581

Dimensions: 52"L x 27"W x 33"H

Quantity	Model #	Part #	Description
5	HOT2-15024D	8.922-738.0	5-Pack Bulk Savings

**Field Installed Options & Accessories**

- 8.750-487.0 Pivot Hose Reel (100' capacity, reel only)
- 8.750-477.0 Non-Pivot Hose Reel (100' capacity, reel only)
- 8.917-541.0 Hose Reel Platform with E-Zee Reel & Plumbing (holds 100' of 3/8" hose, not included)\*
- 8.917-522.0 Hose Reel Platform Only\*
- 8.917-525.0 Wheel Kit (2 casters)
- 8.917-506.0 Float Tank with Inlet Detergent Metering Valve
- 9.802-283.0 Hour Meter (machine pre-wired for easy installation)

\* Should not be used as a lifting rack



# HDS Upright Class



**Hot Water > Electric Powered > Diesel Heated**

Mobility at its finest. This high-performance, robust upright machine offers outstanding maneuverability, easy transport and intuitive operation. Ideal for tradesmen, commercial use and contract cleaners.



- Axial Pumps with 7-year warranty
- Fine mesh filter reliably protects against dirt particle damage
- EASY!Lock - Quick lock screw connection
- Flat-Free Tires & Auto Shutdown
- Compatible with biodiesel fuel
- EASY!Force Trigger gun — zero effort required

Model #	Part #	GPM	PSI	HP	Electrical	Amps	Pumps	Ship Dimensions (L x W x H) inches	Ship Wt (lbs)
HDS 1.7/12 U Ed	1.064-907.0	1.7	1200	2.3	110-120V / 1ph	12.5	Kärcher Axial	28 x 28 x 46	178

Dimensions: 25" L x 25" W x 39"H

## Field Installed Options & Accessories

- 4.118-005.0\* EASY!Force Trigger Gun
- 4.112-006.0\* 33" Spray Lance
- 6.110-034.0\* 33' High-Pressure Hose
- 4.117-027.0\* Triple Jet Nozzle, 032
- 2.112-015.0 Gutter Cleaning Lance
- 4.112-032.0 Underbody Lance
- 6.110-051.0 High-Pressure Hose, 10m DN8 (suitable for food industry, extension piece)
- 6.110-049.0 Pipe Cleaning Hose
- 2.110-013.0 FR 30 ME Surface Cleaner
- 2.111-011.0 Surface Cleaner FR 30
- 4.115-000.0 Wet Blasting Attachment
- 4.113-003.0 Rotating Washing Brush (natural fiber bristles)
- 4.113-004.0 Rotating Washing Brush (nylon bristles)
- 2.113-000.0 Power Nozzle, 25° Spray Angle
- 4.114-019.0 Dirtblaster Nozzle 035
- 4.637-033.0 Detergent Injector for High Pressure
- 2.115-000.0 Quick Coupling
- 2.115-001.0 Plug Nipple
- 4.112-000.0 41" Spray Lance

\* Included



# ENG



**Hot Water > Electric Powered > Natural Gas or LP Heated**

Landa offers the ENG with an even more compact footprint than the 15/20 HP models. Even with a smaller frame, this ENG provides the ultimate in cleaning action, and includes many of the same great features as its larger counterpart. Small in size but big on innovation and quality, the ENG series provides a lot of bang for the buck!



- Compact footprint packs a lot of cleaning ability into a small space
- Patented Cool-Bypass\*\* helps to extend the life of the pump
- Tru-Tite belt tensioning system helps to extend the life of the belt
- Optional LanCom Remote allows users to continue working without having to run back and forth to the machine
- EASY!Force Trigger gun — zero effort required

\*Patent US D735,959 S \*\*Patent US 8,496,188 B2

Model #	NG Part #	LP Part #	GPM	PSI	Pump RPM	Pump	NG BTU*	Motor HP	Volts	Phase	Amps	Ship Wt (lbs)
ENG4-20024A	1.109-800.0	1.109-837.0	3.5	2000	1350	LB4025R	310,000	5.0	230	1	25	815
ENG4-22024A	1.109-801.0	1.109-838.0	4.0	2200	1250	LM4035R	364,000	6.2	230	1	29	843
ENG4-22024B	1.109-802.0	1.109-839.0	4.0	2200	1250	LM4035R	364,000	6.2	230	3	16	843
ENG4-22024C	1.109-803.0	1.109-840.0	4.0	2200	1250	LM4035R	364,000	6.2	460	3	7	843
ENG4-22024F	1.109-804.0	1.109-841.0	4.0	2200	1250	LM4035R	364,000	6.2	575	3	6.5	843
ENG4-22024G	1.109-805.0	1.109-842.0	4.0	2200	1250	LM4035R	364,000	6.2	208	1	30	843
ENG4-22024H	1.109-806.0	1.109-843.0	4.0	2200	1250	LM4035R	364,000	6.2	208	3	18	843
ENG4-30024A	1.109-807.0	1.109-844.0	3.9	3000	1225	LM4035R	354,000	8.2	230	1	36	856
ENG4-30024B	1.109-808.0	1.109-845.0	3.9	3000	1225	LM4035R	354,000	8.2	230	3	25	856
ENG4-30024C	1.109-809.0	1.109-846.0	3.9	3000	1225	LM4035R	354,000	8.2	460	3	11	856
ENG4-30024F	1.109-810.0	1.109-847.0	3.9	3000	1225	LM4035R	354,000	8.2	575	3	14	856
ENG4-30024G	1.109-811.0	1.109-848.0	3.9	3000	1225	LM4035R	354,000	8.2	208	1	38	856
ENG4-30024H	1.109-812.0	1.109-849.0	3.9	3000	1225	LM4035R	354,000	8.2	208	3	27	856
ENG5-23024A	1.109-813.0	1.109-850.0	5.0	2300	1200	LT6035R	439,000	8.2	230	1	36	856
ENG5-23024B	1.109-814.0	1.109-851.0	5.0	2300	1200	LT6035R	439,000	8.2	230	3	25	856
ENG5-23024C	1.109-815.0	1.109-852.0	5.0	2300	1200	LT6035R	439,000	8.2	460	3	11	856
ENG5-23024F	1.109-816.0	1.109-853.0	5.0	2300	1200	LT6035R	439,000	8.2	575	3	14	856
ENG5-23024G	1.109-817.0	1.109-854.0	5.0	2300	1200	LT6035R	439,000	8.2	208	1	38	856
ENG5-23024H	1.109-818.0	1.109-855.0	5.0	2300	1200	LT6035R	439,000	8.2	208	3	27	856
ENG5-30024A	1.109-819.0	1.109-856.0	4.8	3000	1160	LT6035R	415,000	10.0	230	1	42	885
ENG5-30024B	1.109-820.0	1.109-857.0	4.8	3000	1160	LT6035R	415,000	10.0	230	3	26	885
ENG5-30024C	1.109-821.0	1.109-858.0	4.8	3000	1160	LT6035R	415,000	10.0	460	3	15	885
ENG5-30024F	1.109-822.0	1.109-859.0	4.8	3000	1160	LT6035R	415,000	10.0	575	3	14	885
ENG5-30024G	1.109-823.0	1.109-860.0	4.8	3000	1160	LT6035R	415,000	10.0	208	1	49	885
ENG5-30024H	1.109-824.0	1.109-861.0	4.8	3000	1160	LT6035R	415,000	10.0	208	3	32	885

Dimensions: 49"L x 24"W x 48"H \* See product bid specifications for details regarding LP BTUs. Ratings may vary.



# ENG

## Hot Water > Electric Powered > Natural Gas or LP Heated

If you're tight on space but have big cleaning needs, Landa's patented\* ENG is the perfect machine for you! There isn't a more compact natural gas pressure washer on the market. The ENG packs a ton of features into an incredibly tiny footprint. Start with Landa's patented Cool-Bypass\*\* system that keeps the water temperature low while the machine is in bypass mode, extending the life of the pump. Other innovative features include Landa's Tru-Tite belt tensioning system, which relies on a spring-loaded idler arm to keep the belt aligned and tensioned, reducing wear and tear on the belt; and the Fielder's Choice system, which allows you to switch the inlet/outlet connections from one side to the other, adding versatility and making installation a breeze.



Compact footprint packs a lot of cleaning ability into a small space  
 Patented Cool-Bypass\*\* helps to extend the life of the pump  
 Tru-Tite belt tensioning system helps to extend the life of the belt  
 Optional LanCom Remote allows users to continue working without having to run back and forth to the machine  
 EASY!Force Trigger gun – zero effort required

\*Patent US D735,959 S \*\*Patent US 8,496,188 B2

Model #	NG Part #	LP Part #	GPM	PSI	Pump RPM	Pump	NG BTU*	Motor HP	Volts	Phase	Amps	Ship Wt (lbs)
ENG6-32024B	1.109-825.0	1.109-862.0	6.3	3200	1525	LT6035R	507,000	15.0	230	3	39	1825
ENG6-32024C	1.109-826.0	1.109-863.0	6.3	3200	1525	LT6035R	507,000	15.0	460	3	19	1825
ENG6-32024F	1.109-827.0	1.109-864.0	6.3	3200	1525	LT6035R	507,000	15.0	575	3	18	1825
ENG6-32024H	1.109-828.0	1.109-865.0	6.3	3200	1525	LT6035R	507,000	15.0	208	3	39	1825
ENG8-32024B <sup>†</sup>	1.109-829.0	1.109-866.0	8.0	3200	1370	LX9536R	658,000	20.0	230	3	46	1840
ENG8-32024C <sup>†</sup>	1.109-830.0	1.109-867.0	8.0	3200	1370	LX9536R	658,000	20.0	460	3	26	1840
ENG8-32024F	1.109-831.0	1.109-868.0	8.0	3200	1370	LX9536R	658,000	20.0	575	3	21	1840
ENG8-32024H <sup>†</sup>	1.109-832.0	1.109-869.0	8.0	3200	1370	LX9536R	658,000	20.0	208	3	60	1840
ENG10-30024B <sup>†</sup>	1.109-833.0	1.109-870.0	9.5	3000	1400	LX1036R	816,000	20.0	230	3	52	1910
ENG10-30024C <sup>†</sup>	1.109-834.0	1.109-871.0	9.5	3000	1400	LX1036R	816,000	20.0	460	3	26	1910
ENG10-30024F	1.109-835.0	1.109-872.0	9.5	3000	1400	LX1036R	816,000	20.0	575	3	21	1910
ENG10-30024H <sup>†</sup>	1.109-836.0	1.109-873.0	9.5	3000	1400	LX1036R	816,000	20.0	208	3	60	1910

Dimensions: 64"L x 35"W x 61"H <sup>†</sup>EASY!Force not available on this model. See product bid specifications for details regarding LP BTUs. Ratings may vary.

### Field Installed Options & Accessories

- 8.917-509.0 LanCom Wireless Remote System
- 8.921-832.0 Additional LanCom Wireless Remote
- 8.917-817.0 LanCom Wireless Remote Wall Mount Bracket
- 8.921-773.0 Wired Remote Control Kit for Detergent (requires 8.921-774.0)
- 8.921-774.0 Wired Remote Control Kit for Pump & Burner
- 8.922-157.0 Remote Control Box (for additional wired remotes only)
- 8.917-507.0 Snap-N-Go Auto Start/Stop Kit w/ Lock Out (no remote or wireless remote)
- 9.807-646.0 Snap-N-Go Auto Start/Stop Kit w/o Lock Out (wired remote, requires 8.921-774.0)

### Field Installed Options & Accessories

- 8.917-508.0 Snap-N-Go Time Delay Kit
- 8.921-776.0 Steam Combo Kit
- 9.801-040.0 Draft Diverter, 10" (Fits 4 and 5 GPM Models)
- 8.717-730.0 Draft Diverter, 12" (Fits 6, 8 and 10 GPM Models)
- 8.753-474.0 Draft Damper, 10"
- 8.753-478.0 Draft Damper, 12"
- 8.753-707.0 Reducer, Stack 10" to 8"
- 8.753-706.0 Reducer, Stack 12" to 10"
- 8.923-213.0 Fielder's Choice System

# VHG



## Hot Water > Electric Powered > Natural Gas or LP Heated

Compact but heavy duty, this natural gas model's footprint is a mere 24" x 53" for the smallest unit, making it an ideal choice for congested work areas or wash bays where space is at a premium. The small size makes it no less efficient; with cleaning power up to 3000 PSI and 4.8 GPM, this machine delivers enough cleaning action to tackle a variety of challenges, and includes an optional wireless remote control. The VHG is especially adept at cleaning and maintaining the appearance of the dirtiest fleet or construction equipment.



- Belt-Drive Landa Pump with 7-year warranty
- Patented Cool-Bypass\*
- Smart control provides control over run time, auto start/stop and shutdown functionality
- Optional wireless remote allows users to work up to 300 feet away
- EASY!Force Trigger gun — zero effort required

\*Patent US 8,496,188 B2

Model #	Part #	GPM	PSI	Pump RPM	Pump	Motor HP	Volts	Phase	Amps	Approx BTUs	Ship Wt (lbs)
VHG4-20024A	1.109-534.0	3.5	2000	1175	LM4035R.3	5.0	230	1	25	364,000	750
VHG4-22024A	1.109-535.0	4.0	2200	835	LT6036R.2	6.2	230	1	27	364,000	790
VHG4-22024B	1.109-536.0	4.0	2200	835	LT6036R.2	6.2	230	3	15	364,000	770
VHG4-22024C	1.109-537.0	4.0	2200	835	LT6036R.2	6.2	460	3	8	364,000	780
VHG4-22024G	1.109-538.0	4.0	2200	835	LT6036R.2	6.2	208	1	29	364,000	790
VHG4-22024H	1.109-539.0	4.0	2200	835	LT6036R.2	6.2	208	3	18	364,000	780
VHG4-30024A	1.109-541.0	3.9	3000	775	LT6036R.2	8.2	230	1	36	354,000	868
VHG4-30024B	1.109-542.0	3.9	3000	775	LT6036R.2	8.2	230	3	25	354,000	815
VHG4-30024C	1.109-543.0	3.9	3000	775	LT6036R.2	8.2	460	3	15	354,000	815
VHG4-30024G	1.109-544.0	3.9	3000	775	LT6036R.2	8.2	208	1	38	354,000	815
VHG4-30024H	1.109-545.0	3.9	3000	775	LT6036R.2	8.2	208	3	27	354,000	815
VHG5-30024B	1.109-546.0	4.8	3000	1035	LT6036R.2	10.0	230	3	29	480,000	780
VHG5-30024C	1.109-547.0	4.8	3000	1035	LT6036R.2	10.0	460	3	14	480,000	835
VHG5-30024H	1.109-548.0	4.8	3000	1035	LT6036R.2	10.0	208	3	30	480,000	780

Dimensions: VHG4/VHG5 53"L x 24"W x 49"H

### Field Installed Options & Accessories

#### Available for All Models

- 8.924-815.0 Wired Remote Operator Station Kit (use for as primary or secondary remote)
- 8.924-816.0 Electronic Detergent Kit (compatible with wired or wireless remotes)
- 8.924-814.0 Wireless 6 Channel Remote Kit (one remote)\*
- 8.925-072.0 Wireless 6 Channel Remote Kit (two remotes)\*
- 8.924-878.0 Wall Mount Remote Bracket Kit
- 9.802-633.0 LP Gas Regulator Assembly

Factory Installed \* Special Ordering Process, 90-Day Lead Time

### Field Installed Options & Accessories

#### Options For Older VHG Units Only [Pre Smart Control]

- 8.941-545.0 Additional LanCom Remote
- 8.930-131.0 Wall Mount Bracket for Fixed LC Remote

#### Available for Models Up to 5 GPM

- 8.903-543.0 Wheeled Cart for VHG Propane Model
- 9.801-040.0 Draft Diverter, 10"
- 9.801-019.0 LP Conversion Kit
- 8.903-541.0 SS Coil Wrap, 4-Panel Skirt & Cover
- 8.903-542.0 Small Stainless Steel Coil Wrap



# VHP



**Hot Water > Electric Powered > LP Gas Heated**

Looking for a heavy-duty pressure washer that can handle the dirt and grime indoors and out? Then the versatile VHP is the right machine for the task. Available in both 120V and 230V configurations, this hot water pressure washer features cleaning power up to 2.5 GPM and 2000 PSI. And, since the VHP is built with tubed pneumatic tires, this heavy-duty series delivers power wherever the job takes you. It is designed for vapor type propane only.



- Belt-Drive Landa Pump with 7-year warranty
- Four tubed pneumatic tires provide excellent maneuverability
- Extra-durable heating coil is made of leak-free, cold-rolled, Schedule 80 steel pipe and features a five-year warranty
- Features a rugged 10 gauge steel chassis with polyester powder coat finish
- EASY!Force Trigger gun — zero effort required

Model #	Part #	GPM	PSI	Pump RPM	Pump	Motor HP	Volts	Phase	Amps	Approx BTUs	Ship Wt (lbs)
VHP2-15024D	1.109-556.0	1.8	1500	1100	LB3030R	2	120	1	17	140,000	470
VHP3-20024A	1.109-557.0	2.5	2000	1375	LB3030R	5	230	1	20	245,000	500

Dimensions: 50"L x 26"W x 41"H

**Field Installed Options & Accessories**

- 8.903-538.0 Stainless Steel Coil Wrap & Motor Cover \*
- 8.903-501.0 Electric Ignition (convenience in lighting pilot) \*  
Factory Installed

**EHW**



**Hot Water > Electric Powered > Electric Heated**

The perfect choice for in-plant cleaning, this series couldn't be easier to operate – just plug it in and get hot water! The lack of combustible fuels or hazardous fumes makes it safe to store under the stairs or in a closet. The heating coil is uniquely designed for immersion in a tank of hot water for reduced maintenance needs, and a layer of oil floating atop the water assists in heat retention and prevents evaporation. The EHW is enclosed in a stainless steel cabinet and mounted on a platform, and can be fitted with our LanCom wireless remote system, time delay shutdown, and other labor saving options. Generating no fumes or noise, and easy to store, you'll wonder why you didn't choose this unit for your indoor cleaning needs ages ago!

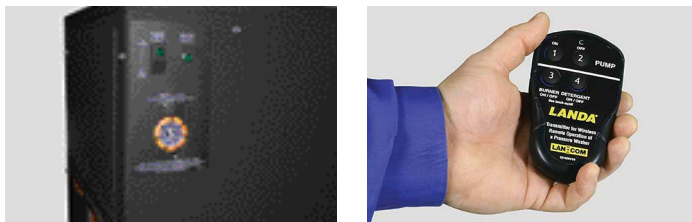

Creates instant hot water without an open flame, combustible fuel or hazardous fumes, making it ideal for in-plant cleaning  
 Belt-Drive Landa Pump with 7-year warranty  
 Time delay shutdown allowing operator to adjust from 2-10 minutes  
 Optional LanCom Remote allows users to work up to 300 feet away  
 EASY!Force Trigger gun – zero effort required

Model #	Part #	GPM	PSI	Pump RPM	Pump	Motor HP	Volts	Phase	Amps	KW	Ship Wt (lbs)
EHW4-20024C	1.109-500.0	4.2	2000	1015	LT6036R.2	6.2	460	3	55	40.5	620
 EHW4-30024C	1.109-501.0	3.5	3000	845	LT6036R.2	7.5	460	3	59	40.5	640
EHW4-20024F	1.109-954.0	3.5	2000	845	LT6036R.2	5.0	575	3	46	40.5	620
EHW4-30024F	1.109-955.0	3.5	3000	845	LT6036R.2	7.5	575	3	49	40.5	640

Dimensions: 34"L x 25"W x 52"H

**Field Installed Options & Accessories**

- 8.930-163.0 LanCom Wireless Remote Control System, 1-Step Detergent \*
- 8.930-177.0 LanCom Wireless Remote Control System, 2-Step Detergent \*
- 8.930-358.0 Additional LanCom Remote \*
- 8.930-131.0 Wall Mount Bracket for Fixed LanCom Remote \*

Factory Installed      \* For 460V Units Only



# MHC



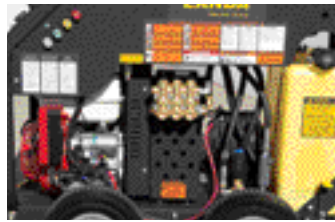

**Hot Water > Gasoline Powered > Diesel/Oil Heated**

With a rugged frame, stainless steel top wrap, and 13" flat-free tires, the MHC is both durable and portable, and easy to maneuver over flat surfaces and around corridors and hallways. The control panel is strategically located, allowing you to easily adjust the thermostat and hour meter depending on your needs. A technologically advanced engine-and-regulator combination eliminates the need for a battery or electrical connection, making it a convenient and versatile on-site choice for keeping your restaurant, resort, spa, or hotel clean and inviting!



- Direct- or Belt-Drive Landa Pump with 7-year warranty
- Stainless steel top wrap
- 13" Flat-free tires and a wheel brake for added stability
- Optional caster wheel kit for easier maneuverability
- Optional Cool-Bypass\*
- EASY!Force Trigger gun — zero effort required

\*Patent US 8,496,188 B2a

Model #	Part #	GPM	PSI	Pump RPM	Pump Drive	Pump	Engine	CCs	Ship Wt (lbs)
MHC3-30324	1.110-038.0	3.0	3000	3400	Direct	LP3035G1	Honda GX270	270	575
MHC4-30324	1.110-039.0	3.5	3000	3400	Direct	LS3540G3	Honda GX340	337	590
 MHC4-30324E	1.110-040.0	3.5	3000	3400	Direct	LS3540G3	Honda GX340	337	595
MHC4-30324E/S	1.110-041.0	3.5	3000	3400	Direct	LS3540G3	Honda GX390	389	600
 MHC4-35324E	1.110-042.0	3.5	3500	3400	Direct	LS3540G3	Honda GX390	389	600
<b>NEW</b> MHC4-35324E/B	1.110-077.0	3.5	3500	1800	Belt	LS3540L.3	Honda GX390	389	600

Dimensions: 52"L x 29"W x 45"H

**Field Installed Options & Accessories**

- 8.915-496.0 360° Pivot Hose Reel Kit (100' capacity, reel only)
- 8.750-487.0 Pivot Hose Reel (100' capacity, reel only)
- 8.750-477.0 Non-Pivot Hose Reel (100' capacity, reel only)
- 8.917-541.0 Hose Reel Platform with E-Zee Reel & Plumbing (holds 100' of 3/8" hose, not included)\*
- 8.917-522.0 Hose Reel Platform Only\*
- 8.915-404.0 Wheel Kit (2 front caster wheels)
- 8.915-406.0 Float Tank & Inlet Detergent Valve
- 8.916-184.0 Lifting Bracket
- 8.915-494.0 Trailer Mount Kit

\* Should not be used as a lifting rack



# PGDC



**Hot Water > Gasoline Powered > Diesel/Oil Heated**

Using a 12-volt DC burner assembly offers a rugged skid frame with robust cleaning performance specifications at an economical price. This self-contained workhorse can tackle virtually any outdoor cleaning project once you provide the water. An optional wheel kit makes this already versatile machine even more portable, allowing for easy transport on-site. With a reliable Honda or Vanguard gasoline engine, this machine can provide hours of continuous worry-free cleaning power.



Heavy-duty Honda or Vanguard engines with keyed electric start  
 Belt-Drive Landa Pump with 7-year warranty  
 Stainless steel top wrap  
 Safety features include a rupture disk, thermal pump protector, and high-temperature shutoff to guard against buildup of excessive heat or pressure  
 EASY!Force Trigger gun — zero effort required

\*Patent US D665,901 S

Model #	Part #	GPM	PSI	Pump RPM	Pump	Engine	CCs	Ship Wt (lbs)
PGDC4-35324E	1.110-049.0	3.8	3500	1185	LT4540L.2	Honda GX390	389	697
PGDC5-35224E	1.110-050.0	4.7	3500	1185	LT6036L.2	Vanguard 18	570	630
PGDC5-35324E	1.110-051.0	4.7	3500	1185	LT6036L.2	Honda GX630	688	653
PGDC8-30324E	1.110-072.0	8.0	3000	1460	LX9536L.2	Honda GX660	688	760

Dimensions: 48"L x 32"W x 44"H E = Electric start engine (battery not included)

**Field Installed Options & Accessories**

- 8.904-525.0 Wheel Kit (4 tires)
- 8.915-496.0 360° Pivot Hose Reel Kit (100' capacity, reel only)
- 8.903-522.0 Non-Pivot Hose Reel Mounting Kit (100' capacity, reel only)
- 9.804-067.0 E-Zee Hose Reel (100' capacity, reel only)
- 8.749-946.0 Vinyl Skid Cover
- 8.916-588.0 Stainless Steel Bottom Wrap
- 8.916-606.0 Float Tank with Inlet Detergent Metering Valve

Factory Installed



# PGHW



## Hot Water > Gasoline Powered > Diesel/Oil Heated

There is a reason this model has been our most popular skid unit for over two decades – classic rugged design with a compact footprint. Whether you drop this into the bed of a pickup or mount on a custom trailer, this gasoline-powered machine is meant to travel to wherever the dirt and grime needs to be attacked. With models capable of delivering up to 5 gallons of water per minute and up to 5,000 pounds per square inch of surface pressure you can choose a model tailor fit for your individual cleaning application. You will find this model a favorite among contract cleaners, facilities managers, municipalities, and oil field service companies because it delivers solid performance and unmatched reliability.



- Belt-Drive Landa Pump with 7-year warranty
- Industrial-duty gasoline-powered engine with overhead valves
- Rugged 1½-inch square tube open-air frame with forklift guides
- Rust-free float tank provides backflow protection
- Inlet detergent injection applies soap while washing in high-pressure mode
- EASY!Force Trigger gun – zero effort required

Model #	Part #	GPM	PSI	Pump RPM	Pump	Engine	CCs	Ship Wt (lbs)
PGHW4-30324E	1.110-048.0	3.5	3000	1125	LT4540L.2	Honda GX390	389	725
PGHW5-30224E	1.110-046.0	4.8	3000	1375	LT6036L.2	Vanguard 18	570	825
 PGHW5-35324E	1.110-045.0	4.7	3500	1360	LT6036L.2	Honda GX630	688	840
PGHW4-40324E	1.110-047.0	4.0	4000	1425	LT4540L.2	Honda GX630	688	840
PGHW5-50524E*	1.110-512.0	5.0	5000	1585	LX5450L	Kawasaki FD2750D	745	1285
PGHW8-30324E <sup>†</sup>	1.110-071.0	8.0	3000	1460	LX9536L.2	Honda GX660	850	850

Dimensions: 48"L x 32"W x 44"H PGHW5-50524E 48"L x 39"W x 42"H  
 E = Electric start engine (battery not included) <sup>†</sup>EASY!Force not available on this model. \* PGHW5-50524E cannot be sold into or out of California

### Field Installed Options & Accessories

- 8.915-496.0 360° Pivot Hose Reel Kit (100' capacity, reel only)
- 8.903-522.0 Non-Pivot Hose Reel Mounting Kit (100' capacity, reel only)
- 9.804-067.0 E-Zee Hose Reel (100' capacity, reel only)
- 8.904-525.0 Wheel Kit (4 tires)\*\*
- 8.749-946.0 Vinyl Skid Cover\*\*
- 8.916-585.0 Steam Valve Kit
- 8.916-588.0 Stainless Steel Bottom Wrap

\* Factory Installed      \*\* Not available for PGHW5-50524E



# PDHW



## Hot Water > Diesel Powered > Diesel/Oil Heated

This series fills the gap for those who are looking for the versatility of a compact pressure washer with the ruggedness and cleaning power of a full-size skid unit. It's packed with features and options that make it highly adaptable for use in a variety of different applications. You'll find a 2,900-watt generator that provides plenty of power for the burner, as well as a 120V outlet for low-wattage needs; forklift guides for easy transporting, mounting brackets to attach to a trailer, and an oversized, tilt-out fuel tank that'll assure you have hours of uninterrupted cleaning. A sturdy steel frame is available in a polyester powder coat finish for added weather protection, or all-stainless steel for the ultimate insurance in high corrosion environments, making this unit the ideal choice for an offshore oil drilling operation. Highly versatile and built with the same attention to quality you've come to expect from Landa, the PDHW is a great all-around "mid-size" choice for all your cleaning needs!



- Industrial-duty Kubota diesel engine with keyed electric start
- Belt-Drive Landa Pump with 7-year warranty
- High-efficiency 12V burner on some models
- Conveniently placed control panel features indicator lights and hour meter
- Optional wheel kit, hose reel platform, spark arrestor, and lift/stack platform
- EASY!Force Trigger gun — zero effort required

Model #	Part #	GPM	PSI	Pump RPM	Pump	Engine	CCs	Burner Voltage	Ship Wt (lbs)
PDHW5-35624E	1.110-060.0	4.7	3500	1125	LT6036L.2	Kubota Z602	599	12V DC	948
PDHW5-35624E/SS	1.110-061.0	4.7	3500	1125	LT6036L.2	Kubota Z602	599	12V DC	948
PDHW5-35624E/G	1.110-062.0	4.7	3500	1125	LT6036L.2	Kubota Z602	599	120V AC	998
PDHW5-35624E/G/SS	1.110-063.0	4.7	3500	1125	LT6036L.2	Kubota Z602	599	120V AC	998

Dimensions: 48"L x 32"W x 44"H E = Electric start engine (battery not included) G = 2,900 watt generator SS = Stainless steel frame

### Field Installed Options & Accessories

- 8.919-983.0 Hose Reel Platform Kit
- 8.904-525.0 Wheel Kit (4 tires)
- 8.919-981.0 Float Tank with Inlet Injection Kit
- 9.802-225.0 Downstream Detergent Injector Kit
- 8.919-984.0 Lifting Sling Kit
- 8.919-990.0 Lift/Stack Platform Kit
- 8.920-298.0 Lift/Stack Platform Kit, Stainless Steel
- 8.919-985.0 Stainless Steel Drip Pan Kit
- 8.919-988.0 Emergency Air Shutoff Kit
- 8.919-989.0 Engine Spark Arrestor Kit



# SLT



## Hot Water > Diesel or Gas Powered > Diesel/Oil Heated

The SLT is a beast and is the go-to pressure washer for many workers in the mining, drilling and fleet industries. It has no problem taking on stubborn grime and grease. With its most powerful model reaching cleaning conditions of up to 8.0 GPM and 3200 PSI, the SLT has the ability to reach hot water temperatures of up to 200°F. Its unique stainless steel coil top wrap offers protection, while its oversize vibration isolators help to cushion the engine and pump platform. With extra-large heating coils and fuel tanks, there's no wonder why the SLT is the preferred cleaning machine by so many industrial professionals.



Powered by either a diesel Kubota engine or gasoline Honda engine  
 Belt-Drive Landa Pump with 7-year warranty  
 Delivers enough water flow to operate two spray guns at the same time  
 Oversized vibration isolators reduce engine-pump vibration  
 Pre-plumbed for drawing water from an auxiliary tank  
 EASY!Force Trigger gun — zero effort required

Model #	Part #	GPM	PSI	Pump RPM	Pump	Engine	CCs	Engine Fuel	Ship Wt (lbs)
SLT6-32324E	1.110-520.0	5.9	3200	1570	LT6036L.2	Honda GX630	688	Gasoline	1245
SLT8-30324E <sup>1</sup>	1.110-522.0	7.8	3000	1470	LX9536L.2	Honda GX660	688	Gasoline	1230
SLT6-32624E	1.110-065.0	6.25	3200	1625	LT6036L.2	Kubota D1105	1123	Diesel	1745
SLT8-32624E <sup>1</sup>	1.110-066.0	8.0	3200	1450	LX9536L.2	Kubota D1105	1123	Diesel	1811

Dimensions: SLT6/SLT8 Gasoline 55"L x 32"W x 51"H SLT6/SLT8 Diesel 62"L x 32"W x 57"H  
 E = Electric start engine (battery not included) <sup>1</sup> EASY!Force not available on this model.

### Field Installed Options & Accessories

- 8.920-751.0 Float Tank w/ Inlet Chemical Injection
- 8.904-456.0 Downstream Injector
- 8.920-977.0 Steam Valve

# SLX



**Hot Water > Diesel or Gas Powered > Diesel/Oil Heated**

As large and powerful as they come, the SLX makes easy work of the most stubborn grime and grease, making it ideally suited for the harsh conditions of mining and drilling operations and fleet cleaning. The SLX is the biggest portable pressure washer in the industry, capable of delivering water as hot as 200°F; with up to 9.2 GPM, there is enough flow to support dual-gun operation. A distinctive stainless steel coil top wrap offers protection, and oversize vibration isolators cushion the engine and pump platform. With extra-large heating coils and fuel tanks, these rugged machines will deliver, even under the dirtiest of conditions.



Especially suited for harsh conditions and fleet cleaning  
 Powered by either a diesel Kubota engine or gasoline Honda engine  
 Belt-Drive Landa Pump with 7-year warranty  
 Delivers enough water flow to operate two spray guns at the same time  
 Oversized vibration isolators reduce engine-pump vibration  
 Pre-plumbed for drawing water from an auxiliary tank

Model #	Part #	GPM	PSI	Pump RPM	Pump	Engine	CCs	Engine Fuel	Ship Wt (lbs)
SLX10-25324E	1.110-525.0	9.5	2500	1560	LX1036L.2	Honda GX660	688	Gasoline	2020
SLX10-32624E	1.110-067.0	9.2	2800	1640	LX1036L.2	Kubota D1105	1123	Diesel	2120

Dimensions: SLX10 Gasoline 65"L x 36"W x 58"H SLX10 Diesel 65"L x 36"W x 61"H  
 E = Electric start engine (battery not included)

**Field Installed Options & Accessories**

- 8.920-751.0 Float Tank w/ Inlet Chemical Injection
- 8.904-456.0 Downstream Injector
- 8.920-977.0 Steam Valve

# ECOS



## Hot Water > Gasoline Powered > Diesel/Oil Heated

If you're looking for a "green" solution to wash water disposal, Landa's patented\* and revolutionary ECOS Mobile Wash and Reclaim System should be right up your alley. This environmentally friendly, patented mobile wash system combines a hot water pressure washer with a wash water recovery and filtration system atop a trailer unit, making it simple to dispose of the gray wash water from your pressure washing operation, or recycle and reuse it. You'll be in compliance with most municipal regulations, and will be doing your part to help conserve our precious natural resources. Contract cleaners, municipalities, and ports can all benefit from the addition of an ECOS mobile wash system to their stable of equipment.



Four polyethylene water tanks provides 400 gallons of cleaning water  
 Locked compartment includes dual fuel tanks for gas engine and diesel burner, and includes space for two detergent buckets  
 Solution to wastewater disposal problems, captures, filters and recycles wash water for continuous use  
 EASY!Force Trigger gun — zero effort required

\*Patent US D701,357 S

Model #	Version	Part #	GPM	PSI	Pump RPM	Engine	CCs	GVWR (lbs)	Water Tank	Ship Wt (lbs)
ECOS-7000	Standard	1.103-825.0	4.7	3500	1360	Honda GX660	688	6,000	400 gal	3500
ECOS-7000	LX	1.103-838.0	4.7	3500	1360	Honda GX660	688	6,000	400 gal	3500
ECOS-7000	DX	1.103-839.0	4.7	3500	1360	Honda GX660	688	6,000	400 gal	3500

Dimensions: 174"L x 75"W x 74"H

### Field Installed Options & Accessories

8.739-074.0	Landa Hose 6000 PSI Hose, 100'
8.922-019.0	Spare Tire Kit, ECOS Trailer - No Panel (tire not included)
8.922-020.0	Spare Tire Kit, ECOS Trailer - With Panel (tire not included)
8.752-044.0	Tire/Wheel Assembly, Black, 15" Radial
8.903-606.0	Water Jet Surface Cleaner
8.922-791.0	Vacuum Nozzle Guard, Stainless Steel Plate

### Field Installed Options & Accessories

#### Replacement Filters and Parts

8.726-042.0	Filter Bag
8.726-045.0	5 Micron Carbon Filter Cartridge
8.726-044.0	20 Micron Pleated Filter Cartridge
8.754-082.0	200 Micron Pre-Filter Nylon Sock
8.726-046.0	Oil Absorbent Sock
8.919-317.0	Vacuum Nozzle Head Assembly with Guard

#### Drain Covers and Water Dikes

8.751-135.0	Drain Cover, 36" x 36", 30oz PVC
8.751-136.0	Drain Cover, 48" x 48", 30oz PVC
8.751-137.0	Drain Cover, 48" x 48", Urethane
8.751-138.0	Water Dike, 10', 22oz PVC
8.751-139.0	Water Dike, 10', 40oz Urethane
8.751-140.0	Water Dike, 20', 22oz PVC
8.751-141.0	Water Dike, 20', 40oz Urethane

ECOS Comparison Chart	Standard	LX	DX
LED Lighting			
Standard Lighting			
Reflective Conspicuity Tape			
2 5/16-inch Ball Coupler			
Adjustable Lunette Hitch			
Spare Tire Configuration			
Sediment Filter Microns	50	20	20
Polish Filter Microns	20	5	5

= standard features      = available options



# TULE Series Trailer

**Hot Water > Gasoline Powered > Diesel/Oil Heated**

Towable and maneuverable hot water pressure washer. Ready to pick up and go at a moments notice, the Tule Series HDS 3.5/40 Ge MT hot water pressure washer trailer provides the necessary cleaning power on virtually any job site which has a water source. Simply unhitch the Tule Series HDS 3.5/40 Ge MT and take the cleaning power where you need it most. The Tule Series trailer features a reliable Honda engine, 8 gallon diesel fuel tank, electric start with manual start backup and much more.

U.S. Design Patent No. 9,724,734 B2



Shown with optional hose reel



- Honda GX 390 engine and electric start with manual start backup
- Adjustable thermostat for water temperature regulation
- 8 gallon diesel fuel tank
- Lift handle and swing away tongue for easier hook up of the trailer and storage
- EASY!Force Trigger gun — zero effort required

Model #	Part #	GPM	PSI	Drive	Burner	Engine	Start	Pump	Ship Wt (lbs)
HDS 3.5/40 Ge MT	1.103-844.0	3.5	4000	Direct	12V / DC	Honda GX390	Electric*	Karcher KS	750

Dimensions: 100"L x 45"W x 75"H

### Field Installed Options & Accessories

- 8.756-481.0\* EASY!Force trigger gun (North American Model) - zero force required. Standard 1/4" connection for wand, 3/8" connection for hose
- 8.756-797.0\* 3 - 5 GPM Chemical Injector Kit
- 8.754-990.0\* 12V Battery (required for hot water operation)
- 8.924-366.0\* 2-inch ball coupler
- 8.711-293.0\* Zinc plated variable pressure lance
- 8.925-182.0 50', 3/8" hose, double-wire at 6000 PSI
- 8.924-367.0 2<sup>5</sup>/<sub>16</sub>" Ball Coupler
- 8.924-667.0 Lifting Kit
- 8.924-370.0 LED Lights
- 8.924-700.0 2-inch Collar Lock Coupler
- 8.750-682.0 Hose Reel Fixed 100', 5000 PSI, 325°F (equipped for 3/8" hose, reel only)
- 8.925-255.0 Hose Reel Bracket (mount kit)

Factory Installed \* Included

# TR Trailer



**TR-3500 Single Axle Trailer**



**TR-6000 Tandem Axle Trailer**  
Tool box shown is no longer available on this unit.

## Hot Water > Diesel or Gas Powered > Diesel/Oil Heated

On-site cleaning often requires the use of heavy, bulky equipment that isn't always easily transportable. Landa offers a pair of rugged, top quality trailer-mounted wash systems to ease your burden. Available with a dual-axle or single-axle trailer, the TR features 2-by-3 inch structural tubing, standard electric brakes with break away kit, recessed electrical wiring and taillights, 1,000 lb. swivel jacks with ball couplers for quick and easy hookups, a durable steel cage for holding the equipment in place, 15" white spoke wheels, and a powder-coated epoxy finish to protect against the weather. Both are completely customizable: you'll choose a portable, industrial-grade Landa hot water pressure washer, and select the options and accessories best suited to your cleaning needs, including chrome wheels, brake kits, and hose reels.



- Single or tandem axle, customizable hot water pressure washer trailer
- 200 or 230 gallon white high-density polyethylene water tank
- Powder-coated epoxy finish to help against the outdoor elements
- Optional mounting kits available for SLT, PGHW, PGDC and MHP
- Optional hose reel kits hold up to 200 feet of 3/8-inch high pressure hose
- Standard electric brake kits or optional hydraulic breaks

Model #	Part #	Axel	GVWR (lbs)	Water Tank	Ship Wt (lbs)
TR-3500	1.103-801.0	Single	3500	200 gal	720
TR-6000	1.103-804.0	Tandem	6000	330 gal	1080

Dimensions: TR-3500 130"L x 73"W x 58"H TR-6000 178"L x 80"W x 62"H

### Field Installed Options & Accessories

#### Hose Reel Kits (Hose Not Included)

- 8.902-447.0 Hose Reel Kit (100' capacity, 3/8" high-pressure hose)
- 8.902-448.0 Hose Reel Kit (200' capacity, 3/8" high-pressure hose)
- 8.902-449.0 Hose Reel Kit (100' capacity, 3/4" garden hose)

#### Wheels and Fenders

- 8.902-466.0 Chrome Wheels Upgrade (per pair)
- 8.902-468.0 Chrome Fender Assembly for Tandem Axle Upgrade (per pair)
- 8.902-467.0 Chrome Fender Assembly for Single Axle Upgrade (per pair)
- 8.707-493.0 Chrome Wheel with ST205/75D15/C Tire (each) [spare]

#### Mounting Kits

- 8.902-463.0 Mounting & Plumbing Kit for SLT \*\*
- 8.917-264.0 Mounting & Plumbing Kit for PGHW5-35324E, PGHW4-40324E
- 8.917-262.0 Mounting & Plumbing Kit for PGHW4-30324E
- 8.917-263.0 Mounting & Plumbing Kit for PGHW5-30224E
- 8.920-435.0 Mounting & Plumbing Kit for PDHW5-35624E
- 8.902-456.0 Mounting & Plumbing for PGDC, MHP

Factory Installed \* TR-3500 Only \*\* TR-6000 Only

### Field Installed Options & Accessories

#### Brakes

- 8.902-441.0 Hydraulic Brake Kit (single axle, 2" ball hitch) \*
- 8.902-442.0 Hydraulic Brake Kit (single axle, 3" lunette eye) \*
- 8.902-438.0 Hydraulic Brake Kit (two axles, 2-5/6" ball hitch) \*\*
- 8.902-452.0 Hydraulic Brake Kit (two axles, 3" lunette eye) \*\*

#### Signage Plate

- 8.902-469.0 Signage Plate

#### Vinyl Skid Covers

- 8.709-109.0 Vinyl Skid Cover for PGHW5-50524E
- 8.749-946.0 Vinyl Skid Cover for PGHW, PGDC

#### Chemical Rack

- 8.912-409.0 2-5 gal. Bucket Chemical Rack \*\*

#### Hitch Couplers

- 8.924-493.0 2-5/6" Ball Hitch Coupler \*
- 8.902-436.0 3" Lunette Eye Hitch Coupler \*
- 8.902-471.0 3" Lunette Eye Hitch Coupler \*\*

# TRV Trailer



## Hot Water > Diesel or Gas Powered > Diesel/Oil Heated

When your business is mobile in nature and you're shuttling often between job sites, you'll want the convenience of a portable washing system that allows you to easily transport your cleaning equipment virtually anywhere. Landa's TRV fills that niche beautifully, providing you with a rugged trailer with a heavy-duty chassis, sturdy wheel and axle assembly, 15" white-rimmed wheels, 1,000 lb. swivel jack for maneuvering your unhitched trailer, and a powder-coated epoxy finish for protection against the elements. The trailer is fully customizable — simply choose from five series of portable, industrial-grade Landa hot water pressure washers, add the options and accessories you want, and you're in business! The TRV is an ideal solution for contract cleaners and those with versatile cleaning requirements.



- Single axle, customizable hot water pressure washer trailer
- 200 gallon white high-density polyethylene water tank
- Powder-coated epoxy finish to help against the outdoor elements
- Optional mounting kits available for PDHW, PGHW, PGDC, MHC and MHP
- Optional hose reel kits hold up to 200 feet of 3/8-inch high pressure hose
- Optional surge brake
- Standard electric brakes and break away kit

Model #	Part #	Axle	GVWR (lbs)	Water Tank	Ship Wt (lbs)
TRV-3500	1.103-820.0	Single	3500	200 gal	1072

Dimensions: 136"L x 66"W x 52"H

### Field Installed Options & Accessories

#### Hose Reel Kits (Hose Not Included)

- 8.917-554.0 High Pressure Hose Reel (100' capacity)
- 8.917-555.0 Low Pressure Hose Reel (100' capacity)

#### Wheels

- 8.917-583.0 Wheel Kit (2 chrome wheels)

#### Mounting Kits

- 8.920-434.0 PDHW Mounting Assembly
- 8.917-299.0 PGHW Mounting Assembly \*
- 8.917-399.0 PGDC Mounting Assembly

#### Brakes

- 8.917-398.0 Hydraulic Brakes

Factory Installed \* PGHW5-50524E Not Compatible

### Field Installed Options & Accessories

#### Hitch Couplers

- 8.924-493.0 2-5/16" Ball Hitch Coupler
- 8.902-436.0 3" Lunette Eye Hitch Coupler \*

#### Utility Rack

- 8.917-560.0 Utility Rack (rated for up to 150 lbs)

#### Saddle Boxes

- 8.917-558.0 Saddle Box (each)
- 8.917-556.0 Saddle Boxes (2 boxes)

#### Rock Guards

- 8.917-557.0 Rock Guard
- 8.917-559.0 Rock Guard

#### Battery

- 8.904-051.0 Battery installed on pressure washer



# Denali Series

## High Flow Cold Water > Gasoline Powered

The Denali Series features up to an 8.0 GPM flow rate and 3000 PSI to blast through the toughest jobs on farms and construction sites, perfect for waste and debris removal. Our rugged and economical cold water pressure washer features a high-quality triplex pump and is equipped with a Honda engine for quiet, reliable performance. Three gas cart models allow you to find the right machine for your needs. An optional skid kit also is available. All models equipped with a 50' hose, a chemical injector, and 12V battery.



Optional



Optional

- Belt-drive
- Reliable Honda GX engine with three-year warranty
- Modular design - change to stationary unit with optional skid feet kit
- Flat-free tires and steel cage
- Optional 100' hose reel available
- Machine will fit up to a 100' hose reel

Model #	Part #	GPM	PSI	Start	Drive	CC	Engine	Pump	Ship Wt (lbs)
HD 5/30G	1.107-370.0	5.0	3000	Electric	Belt	688	Honda GX 630	6036R	430
HD 6/30G	1.107-371.0	6.0	3000	Electric	Belt	688	Honda GX 630	6036R	430
HD 8/35G	1.107-372.0	8.0	3500	Electric	Belt	688	Honda GX 690	8043R	441

Dimensions: 50"L x 40"W x 58"H

### Field Installed Options & Accessories

- 8.750-247.0 Trigger Gun, model M407
- 8.925-132.0 Hose, 3/8" X 50' 2W 6000 PSI SW/SO/CPL (5/30 & 6/30)
- 8.925-134.0 Hose, 1/2" X 50' 2W 5000 PSI SW/SO/CPL (8/30)
- 9.802-216.0 Injector Chem, non-adjustable, 3-5 GPM (5/30)
- 8.757-724.0 Injector Chem, non-adjustable, 5-9 GPM (6/30 & 8/30)
- 8.925-229.0 Legacy, 100' x 3/8" ID, 6000 PSI, 2-wire, smooth cover, black high pressure hose
- 8.750-682.0 100' Capacity Hose Reel, Fixed Base
- 8.929-070.0 Skid Kit

# Jarvis HD Series



Photo does not depict 10' hose.



## Cold Water > Flat Surface Cleaner Combo

The Jarvis series is a complete solution for quick, streak-free cleaning of businesses' entrances, parking lots, tennis courts, pool decks and sidewalks. This easy to use cold water surface cleaner pressure washer is an all-in-one unit with the pump and engine attached to the surface cleaner, and it is designed to attack the superficial dirt sweeping alone does not get. The Jarvis series surface cleaner pressure washer is perfect for all operators - simple on / off operation, flat free tires and a folding handle for easy transport and storage.



- 21" corrosion-resistant stainless steel surface cleaner housing and a professional grade swivel design for extended, effortless use
- Reliable Honda GX engine with three-year warranty
- Flat free tires
- Folding handle for easy storage and transport
- Simple on / off operation
- EASY!Force Trigger gun – zero effort required

Model #	Part #	GPM	PSI	Drive	CC	Engine	Pump	Ship Wt (lbs)
SCW 2.4/25 G	1.107-380.0	2.4	2500	Direct	200	Honda GX 200	KP3035G	159

Dimensions: 44.04"L x 27.6"W x 34.2"H

### Field Installed Options & Accessories

- 8.756-481.0 EASY!Force trigger gun (North American Model) - zero force required. Standard 1/4" connection for wand, 3/8" connection for hose.
- 8.711-370.0 Nozzle used on wand
- 8.707-537.0 Nozzle used on spray arm of surface cleaner (2 needed)
- 8.925-467.0 Hose
- 9.802-214.0 Wand

# HD Gas



## Cold Water > Gasoline Powered

Compact and corrosion-resistant, the HD Gas aluminum pressure washers have a durable weldless, modular frame that can be utilized as a cart or converted to a skid (optional) for maximum cleaning versatility and durability. Easy to maneuver with puncture proof, flat free tires. These reliable Honda powered pressure washers offer a bypass loop for additional pump protection, as well as a 7-year warranty on the oil end of the pump. The simple design of the HD Gas helps get the job done quickly and without hassle.

NOTE: Skid feet sold separately.



- Up to 4.0 GPM, 4000 PSI
- Belt- or Direct-Drive Models
- Reliable Honda Engines
- Modular Design
- Flat-Free Tires
- Compact Footprint

Model #	Part #	GPM	PSI	Drive	Start	Pump	Engine	CC	Ship Wt (lbs)
HD 3.0/27 G	9.807-727.0	3.0	2700	Direct	Recoil	LP3035G	Honda GX200	196	112
HD 3.5/35 G	9.807-728.0	3.5	3500	Direct	Recoil	LP3535G1	Honda GX270	270	130
HD 4.0/40 G	9.807-729.0	4.0	4000	Direct	Recoil	LS4040G.3	Honda GX390	389	149
HD 4.0/40 Ge	9.807-730.0	4.0	4000	Direct	Electric	LS4040G.3	Honda GX390	389	158
HD 3.0/27 GB	9.807-731.0	3.0	2700	Belt	Recoil	LB3030R	Honda GX200	196	123
HD 3.5/35 GB	9.807-732.0	3.5	3500	Belt	Recoil	LM3540R.3	Honda GX270	270	156
HD 4.0/40 GB	9.807-733.0	4.0	4000	Belt	Recoil	LM3840R.3	Honda GX390	389	160
HD 4.0/40 GeB	9.807-734.0	4.0	4000	Belt	Electric	LM3840R.3	Honda GX390	389	196

Dimensions: HD3/HD3.5 41"L x 22"W x 24"H HD4/HD4.5 43"L x 26"W x 27"H

### Field Installed Options & Accessories

9.807-754.0	Skid Mount Feet
9.807-750.0	37.5" Long Handle
9.807-753.0	Wand Holder
9.807-752.0	Hose Storage Hook
9.807-751.0	Handle with Hose Reel
8.753-572.0	A+ Surface Cleaner SC21
8.753-573.0	A+ Surface Cleaner SC24
9.302-243.0	Legacy Turbo Nozzle, 4.0, 4350 PSI
8.710-620.0	Legacy Superlite Stainless Steel Lance, 72" - 56.0 oz
8.711-105.0	Rotating Nozzle, 3.0
8.711-100.0	Rotating Nozzle, 5.0
8.925-228.0	Legacy Hose, 100' x 3/8" ID, 6000 PSI, 2-wire, smooth cover, black high pressure hose



# HD Gas Skid



**Cold Water > Gasoline Powered**

Cleaning on the go. The perfect accompaniment to Landa's HD Gas direct drive pressure washers – these mild steel skids offer two configurations: skid with a 50 gallon water tank and one 100' hose reel OR skid with two 100' hose reels. The HD Skids fit within a standard UTV / ATV bed when ordering the direct drive aluminum pressure washer models.

NOTE: Belt drive models extend beyond the frame and are not recommended; pressure washer sold separately.



- 50 gallon water tank (HD Pallet Skid with Tank only)
- Forklift Hole
- Includes Skid Feet
- 1 to 2, 100' Hose Reel
- Fits within standard UTV/ATV bed
- Assembly required

Model #	Part #	Frame Material	Water Tank	Hose Reel	Compatible Pressure Washer *	Ship Wt (lbs)
HD Pallet Skid with Tank	9.807-834.0	Mild Steel	50 gallon	1	HD 3.0/27 G 9.807-727.0 HD 3.5/35 G 9.807-728.0 HD 4.0/40 G 9.807-729.0	185
HD Pallet Skid with 2 Reels	9.807-839.0	Mild Steel	Not Included	2	HD 3.0/27 G 9.807-727.0 HD 3.5/35 G 9.807-728.0 HD 4.0/40 G 9.807-729.0	172

Dimensions: 40"L x 48"W x 35"H \* Pressure washer sold separately

**Field Installed Options & Accessories**

- 8.753-572.0 A+ Surface Cleaner SC21
- 8.753-573.0 A+ Surface Cleaner SC24
- 9.302-243.0 Legacy Turbo Nozzle, 4.0, 4350 PSI
- 8.710-620.0 Legacy Superlite Stainless Steel Lance, 72" - 56.0 oz
- 8.925-228.0 Landa Hose, 100' x 3/8" ID, 6000 PSI, 2-wire, smooth cover, black high pressure hose

# MP



## Cold Water > Gasoline or Diesel Powered

With a variety of available engines delivering up to 5000 PSI, there is no other cold water pressure washer on the market with such versatility and blasting power as these series offer. Portable and rugged, they come equipped with a high-impact steel roll cage and lifting bar as well as two 13" flat-free tires for easy all-terrain maneuverability, making them excellent choices for tackling a variety of cleaning sites. They include 50' of high-pressure hose rated up to 6000 PSI - more than enough for removing the toughest dirt and grime from your equipment.



Diesel model HD 3.4/30 D Cage - optional hose reel

- Powered by a Honda gasoline engine
- Belt-Drive Landa Pump with 7-year warranty
- Rugged roll cage and 10-gauge steel chassis protected with weather-resistant epoxy powder coat paint
- 5-Gallon fuel tank provides up to 5 hours of continuous cleaning
- EASY!Force Trigger gun — zero effort required

Model #	Part #	GPM	PSI	Pump RPM	Pump	Engine	CCs	Engine Fuel	Ship Wt (lbs)
MP-373534	1.107-001.0	3.7	3500	1185	LT4540R	Honda GX390	389	Gasoline	295
MP-455034E*	1.107-002.0	4.5	5000	1185	LX5450R	Honda GX690	688	Gasoline	415
<b>NEW</b> HD 3.4/30 D Cage	1.107-373.0	3.4	3000	1850	LM3540R.3	Kohler KD440	442	Diesel	195

Dimensions: MP-3 42"L x 26"W x 30"H MP-4 46"L x 30"W x 36"H HD 3.4 50"L x 40"W x 56"H  
 E = Electric start engine (battery not included) \*EASY!Force not available on this model. \* Tandem axle model

### Field Installed Options & Accessories

- 9.801-028.0 E-Zee Hose Reel Kit, (single axle, 100' capacity)
- 9.801-029.0 Non-Pivot Hose Reel Kit, (tandem axle, 100' capacity)
- 8.750-682.0 100' Capacity Hose Reel Fixed Base (for HD 3.4/30 D Cage model only)
- 8.929-070.0 Skid feet (for HD 3.4/30 D Cage model only)



# PG



## Cold Water > Gasoline Powered

Landa's flagship series of cold-water pressure washers, the PG is the most popular machine for everyday use in a variety of industrial cleaning applications. Each has a rugged chassis, 13" tires for easy maneuvering over all types of terrain, and shock absorbing, spring-loaded rubber feet to cut down on vibration. Handles on the front and back are easy to grip, so you won't have a problem loading or unloading these machines.

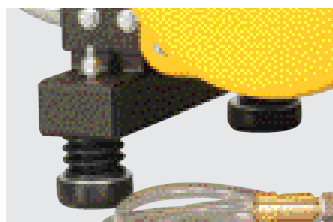

- Powered by a Honda or Vanguard gasoline engine
- Belt-Drive Landa Pump with 7-year warranty
- Rugged 10-gauge steel chassis protected with weather-resistant epoxy powder coat paint
- Two spring-loaded rubber pad feet help to prevent unit from "walking" EASY!Force Trigger gun — zero effort required

Model #	Part #	GPM	PSI	Pump RPM	Pump	Engine	CCs	Ship Wt (lbs)
PG4-20324	1.107-010.0	4.2	2000	1300	LT4540R.2	Honda GX270	270	230
 PG4-35324	1.107-011.0	3.7	3500	1185	LT4540R.2	Honda GX390	389	250
PG5-35224E	1.107-013.0	4.7	3500	1185	LT6036R.2	Vanguard 16	479	275
PG4-40324E*	1.107-012.0	4.0	4000	1190	LT4540R.2	Honda GX630	688	275

Dimensions: 48"L x 27"W x 30"H PG-20324 40"L x 27"W x 25"H E = Electric start engine (battery not included) \*Cannot be sold into California



# PC



PC4-35324

## Cold Water > Gasoline Powered

Like the PG models, the PC cold-water pressure washers offer an array of options and features for cleaning multiple surfaces, but utilize direct-drive instead of belt-drive pumps. Each comes equipped with 50' of Landa's durable wire-braid high-pressure hose, and a thermal pump protector to prevent overheating while in bypass mode. Shock-absorbing rubber feet reduce vibration and prevent movement during operation, and handles on the front and back make these machines a breeze to load and unload.



- Up to 3.8 GPM, up to 4000 PSI
- Powered by a Honda gasoline engine
- Direct-Drive Landa Pump with 7-year warranty
- Rugged 10-gauge steel chassis protected with weather-resistant epoxy powder coat paint
- Two 10-inch, 4-ply, tubed pneumatic tires make for easy maneuvering

Model #	Part #	GPM	PSI	Pump RPM	Pump	Engine	CCs	Ship Wt (lbs)
PC3-24324	1.107-005.0	2.3	2400	3200	LP2535G	Honda GX160	163	130
PC3-27324	1.107-006.0	2.5	2700	3200	LP2535G	Honda GX200	196	135
 PC4-35324	1.107-008.0	3.8	3500	3200	LS4040GS	Honda GX390	389	185
PC4-40324	1.107-224.0	3.5	4000	3200	LS3540G3	Honda GX390	389	188

Dimensions: 35"L x 21"W x 24"H



# HD Electric

## Cold Water > Electric Powered



Designed for versatility, the HD Electric carts are corrosion-resistant aluminum pressure washers that easily convert from a cart to a skid for maximum cleaning agility and durability. These reliable pressure washers have a low profile handle and compact footprint, making them easy to maneuver. They also offer a bypass loop for additional pump protection, a 7-year pump warranty and flat-free tires. All models are ETL certified to UL safety standards.

NOTE: Skid feet sold separately.



- Durable, corrosion resistant aluminum frame
- Modular design - weld free frame easily converts from cart to skid
- VRT3 Unloader with bypass loop - pump protection
- Flat free tires
- Commercial-duty crankcase pump
- ETL certified to UL and CSA standards

Model #	Part #	GPM	PSI	Pump	Pump RPM	Motor HP	Volts	Phase	Amps	Ship Wt (lbs)
HD 2.0/1000 Ed	9.801-805.0	2.0	1000	LF2030S	1725	1.5	120	1	15	162
HD 1.9/1300 Ed	9.801-806.0	1.9	1300	LF2030F	1725	2.0	120	1	20	175
HD 3.0/1000 Ed	9.801-807.0	3.0	1000	LF2830S	1725	2.0	120	1	20	181
HD 3.5/2000 Ea	9.801-808.0	3.5	2000	LF3530F	3450	5.0	230	1	22	182
HD 1.8/1350 Ed*	9.801-809.0	1.8	1350	LF2030F	3450	2.0	120	1	17	180

Dimensions: 41"L x 22"W x 25"H \* HD 1.8/1350 Ed comes equipped with Auto Start/Stop

### Field Installed Options & Accessories

- 9.807-754.0 Skid Mount Feet
- 9.807-750.0 37.5" Long Handle
- 9.807-753.0 Wand Holder
- 9.807-752.0 Hose Storage Hook
- 9.807-751.0 Handle with Hose Reel
- 8.753-572.0 A+ Surface Cleaner SC21
- 8.753-573.0 A+ Surface Cleaner SC24
- 9.302-243.0 Legacy Turbo Nozzle, 4.0, 4350 PSI
- 8.710-620.0 Legacy Superlite Stainless Steel Lance, 72" - 56.0 oz
- 8.711-105.0 Rotating Nozzle, 3.0
- 8.711-100.0 Rotating Nozzle, 5.0
- 8.925-228.0 Landa Hose, 100' x 3/8" ID, 6000 PSI, 2-wire, smooth cover, black high pressure hose

# PE



## Cold Water > Electric Powered

The PE is one of our most popular machines for everyday use in a variety of industrial cleaning applications. Only the highest quality components are used on the PE, including our tri-plex high-pressure pump with 7-year warranty, industrial-duty motor, durable steel frame with welded seams, and a stainless steel point and shoot wand for cleaning effectiveness. In addition to being certified to the rigid UL-1776 safety standards, the PE has a 24-inch hose guard for burst protection and tri-lingual operating instructions for owner liability assurance. A number of features make the PE especially popular with users who seek to reduce their cleaning time, such as handles on both front and back for easy vehicle loading. The pneumatic tires make for easy maneuvering, and two shock absorbing, spring-loaded rubber feet to keep the PE from "walking" while in operation.



- Belt-Drive Landa Pump with 7-year warranty
- Industrial-duty motor
- Rugged 10-gauge steel chassis protected with weather-resistant epoxy powder coat paint
- Two spring-loaded rubber pad feet help to prevent unit from "walking"
- EASY!Force Trigger gun — zero effort required

Model #	Part #	GPM	PSI	Pump RPM	Pump	Motor HP	Volts	Phase	Amps	Ship Wt (lbs)
PE2A-15024D*	1.106-105.0	1.8	1500	1650	LB3030R	2.0	120	1	21	193
PE3-11024D	1.106-009.0	2.8	1000	1540	LB3030R	2.0	120	1	20	193
PE4-20024A	1.106-010.0	4.2	2000	900	LT6036R.2	6.2	230	1	27	285
PE4-20024B	1.106-011.0	4.2	2000	900	LT6036R.2	6.2	230	3	16	265
PE4-20024C	1.106-012.0	4.2	2000	900	LT6036R.2	6.2	460	3	8	266
PE4-30024A	1.106-013.0	3.5	3000	800	LT6036R.2	7.5	230	1	36	337
PE4-30024B	1.106-014.0	3.5	3000	800	LT6036R.2	7.5	230	3	21.5	270
PE4-30024C	1.106-015.0	3.5	3000	800	LT6036R.2	7.5	460	3	10.5	280
PE5-30024B	1.106-016.0	4.8	3000	1060	LT6036R.2	10.0	230	3	26.8	290
PE5-30024C	1.106-017.0	4.8	3000	1060	LT6036R.2	10.0	460	3	13.4	285

Dimensions: 48"L x 28"W x 28"H PE3 44"L x 28"W x 26"H

\* PE2A-15024D comes equipped with Auto Start/Stop, two yellow nozzles, two green nozzles, and a variable pressure wand. Contact your local dealer for more details.



# SEA



**SEA - Stainless Steel**



**SEA - Mild Steel**

## Cold Water > Electric Powered

This top-of-the-line stationary cold-water series features a heavy-duty stainless steel or mild steel cabinet and comes standard with an insulated variable pressure wand, 50' of hose, and time delay shutdown. Available options include our LanCom wireless remote control, floor stand, and wall mount bracket assembly. There is even an optional wheel kit for adding mobility, making an already top-quality machine even more flexible than before. This unit is ideal for cleaning a variety of indoor surfaces, and can be plumbed for plug-and-wash outdoor applications as well.



- Available with a stainless steel cabinet or a mild steel cabinet
- Belt-Drive Landa Pump with 7-year warranty
- Easily accepts hot water up to 185°F
- Optional LanCom Remote allows users to work up to 300 feet away
- Optional wheel kit
- EASY!Force Trigger gun — zero effort required

Model #	Part #	Cabinet	GPM	PSI	Pump RPM	Pump	Motor HP	Volts	Phase	Amps	Ship Wt (lbs)
SEA3-11024D	1.106-500.0	SS	2.8	1000	1540	LB3030R	2.0	120	1	20	210
SEA4-20024A	1.106-501.0	SS	4.2	2000	1013	LT6036R.2	6.2	230	1	28	280
SEA4-20024B	1.106-502.0	SS	4.2	2000	1013	LT6036R.2	6.2	230	3	16	220
SEA4-20024C	1.106-503.0	SS	4.2	2000	1013	LT6036R.2	6.2	460	3	7.2	220
SEA4-20024G	1.106-505.0	SS	4.2	2000	997	LT6036R.2	6.2	208	1	30	297
SEA4-20024H	1.106-506.0	SS	4.2	2000	1028	LT6036R.2	6.2	208	3	18.5	220
SEA4-30024B	1.106-507.0	SS	3.5	3000	943	LT6036R.2	7.5	230	3	21.5	235
SEA4-30024C	1.106-508.0	SS	3.5	3000	943	LT6036R.2	7.5	460	3	10.5	305
SEA3-11024D	1.106-583.0	MS	2.8	1000	1500	LB3030R	2.0	120	1	20	275
SEA4-20024A	1.106-584.0	MS	4.2	2000	1281	LM4035R.3	6.2	230	1	29	275
SEA4-20024B	1.106-585.0	MS	4.2	2000	1281	LM4035R.3	6.2	230	3	11	275
SEA4-20024C	1.106-586.0	MS	4.2	2000	1281	LM4035R.3	6.2	460	3	11	275
SEA4-20024H	1.106-587.0	MS	4.2	2000	1281	LM4035R.3	6.2	208	3	16	275
SEA4-30024B	1.106-588.0	MS	3.5	3000	1070	LM4035R.3	7.5	230	3	19	275
SEA4-30024C	1.106-589.0	MS	3.5	3000	1070	LM4035R.3	7.5	460	3	11	275

Dimensions: 31"L x 21"W x 16"H

### Field Installed Options & Accessories

- 9.801-036.0 Cox Hose Reel Kit (floor stand / wall mount)
- 8.903-521.0 E-Zee Hose Reel & Mounting Kit (fits wheel kit)
- 9.802-265.0 Hose Reel, Mini, (fits wall bracket, 150' capacity)
- 8.711-860.0 Hose Reel, Mini, (fits wall bracket, 100' capacity)
- 9.801-035.0 Wheel Kit (4 casters) for Floor Stands
- 9.801-031.0 Wheel Kit with Detergent Rack
- 8.903-040.0 24" Floor Stand
- 9.801-034.0 36" Floor Stand
- 8.903-617.0 36" Floor Stand (stainless steel)

Factory Installed      \* Float Tank cannot be ordered with Wheel Kit  
 Not compatible with LanCom      Not compatible with Auto Start/Stop or Float Tank options

### Field Installed Options & Accessories

#### Stainless Steel Models Only

- 8.930-163.0 LanCom Wireless Remote Control, 1-Step Detergent
- 8.930-177.0 LanCom Wireless Remote Control, 2-Step Detergent
- 8.903-461.0 Remote On/Off Switch Option (Time Delay units only)
- 8.930-358.0 Additional LanCom Remote
- 8.903-619.0 Wall Mount Bracket Assembly
- 8.930-131.0 Wall Mount Bracket for Fixed LanCom Remote
- 8.903-511.0 Auto Start/Stop (Replaces Time Delay Shutdown)
- 8.904-527.0 Wheel Kit with Detergent Rack (stainless steel)\*
- 8.903-448.0 Float Tank Option with Inlet Soap Injection \*

#### Mild Steel Models Only

- 9.801-011.0 Auto Start/Stop \*
- 9.801-013.0 Hour Meter
- 9.801-012.0 Time Delay Shutdown
- 9.801-033.0 Wall Mount Bracket Assembly



# MPE



## Cold Water > Electric Powered

With a variety of available motors delivering up to 5000 PSI, there is no other cold water pressure washer on the market with such versatility and blasting power as these series offer. Portable and rugged, they come equipped with a high-impact steel roll cage and lifting bar and four 13" flat-free tires for easy all-terrain maneuverability, making them excellent choices for tackling a variety of cleaning sites. They include 50' of high-pressure hose rated up to 6000 PSI - more than enough for removing the toughest dirt and grime from your equipment.



- Up to 5.0 GPM and 5000 PSI
- Belt-Drive Landa Pump with 7-year warranty
- Rugged roll cage and 10-gauge steel chassis protected with weather-resistant epoxy powder coat paint
- Lifting bar for easy maneuverability
- Flat-free tires

Model #	Part #	GPM	PSI	Pump RPM	Pump	Motor HP	Volts	Phase	Amps	Ship Wt (lbs)
MPE5-50024B	1.106-001.0	5.0	5000	1740	LX5450R	20.0	230	3	48	534
MPE5-50024C	1.106-002.0	5.0	5000	1740	LX5450R	20.0	460	3	26	534

Dimensions: 42"L x 26"W x 30"H

### Field Installed Options & Accessories

- 9.801-028.0 E-Zee Hose Reel Kit, (single axle, 100' capacity)
- 9.801-029.0 Non-Pivot Hose Reel Kit, (tandem axle, 100' capacity)



# ZE/ZEF



**ZE2-11026D**



**ZEF2-14024D**

**Cold Water > Electric Powered**

And when it comes to convenience, our ZE/ZEF series can't be beat. This tough handheld unit is designed specifically for cleaning in tight quarters. The ZEF comes standard with a remote on/off switch and Auto Start/Stop. An optional wall mount and wand holder kit is available for those shops where space is at a premium. An extra set of illustrated operation and warning stickers can be placed at eye level, ensuring the safety of all employees in your plant. While it is an excellent choice for cleaning indoor work areas and equipment, its industrial-strength motor and rugged frame make it an effective choice for outdoor jobs, as well.



Direct-Drive Landa Pump with 7-year warranty on ZEF  
 Direct-Drive axial pump with 1-year warranty on ZE  
 Auto Start/Stop comes standard on ZEF  
 Remote wall switch with 10-foot electrical cord supplied with each ZEF for convenience in turning on the unit at a wash station separated from the unit  
 EASY!Force Trigger gun — zero effort required

Model #	Part #	GPM	PSI	Pump Drive	Pump RPM	Pump	Motor HP	Volts	Phase	Amps	Ship Wt (lbs)
ZE2-11026D	1.106-023.0	2.0	1000	Axial	3450	AXD2020E	1.5	120	1	15	93

Dimensions: 15"L x 12"W x 15"H

Model #	Part #	GPM	PSI	Pump Drive	Pump RPM	Pump	Motor HP	Volts	Phase	Amps	Ship Wt (lbs)
ZEF2-14024D	1.107-090.0	1.8	1400	Triplex	1725	LF2030S	2.0	120	1	20	125

Dimensions: 20"L x 19"W x 17"H

**Field Installed Options & Accessories**

- 8.920-952.0 Wall Mount & Wand Holder
- 8.904-464.0 Quick-Coupled Soap Injector, 6' Poly Tubing

# Hot Water Generator



**Model 5.0/30 Ed**



**Model Hot Box**

## Compact, portable hot water generators

Add hot water cleaning economically. Durable and reliable design for attaching to a cold water pressure washer. Our Compact Mobile Series water heaters provide supplemental heat to cold water machines, giving users the benefit of hot water cleaning when it's needed and the convenience of the portable cold water washer. Effectively heats water at a rate of up to 5 gallons per minute.



- Heater add-on for cold water pressure washers
- Effective heating of up to 5 GPM
- Heavy-duty, steel cabinet protected by an epoxy powder coat finish
- Portable, compact size

Model #	Part #	GPM	PSI	Electrical	Amps	BTU/Hour	Heated by	Ship Wt (lbs)
Heater 5.0/30 Ed	1.575-650.0	Up to 5	3000	120V	5	380,000	Diesel	330
Hot Box	1.103-910.0	Up to 5	3000	120V	5	300,000	Diesel, kerosene	320

HDS Heater Dimensions: 35"L x 47"W x 50"H    Hot Box Series Dimensions: 27"L x 37"W x 39"H



# Stationary Hot Water Generator Series

## Heating modules that pack a punch



**Model 9462**



**Model 9452**

The Stationary ThermoGlow heating modules offer the flexibility to “convert” a cold water pressure washer into a hot water unit. By attaching the heating module to a cold water pressure washer the pressurized water is now heated to produce all the benefits of hot water cleaning. The four models use fuel oil, diesel or natural gas to heat the water using high-efficiency, vertical heating coil. All models are equipped with a flow switch to control the burner.

Fuel burner types available:

- Diesel
- Kerosene
- Home Heating Oil
- Natural Gas
- LP Gas (optional)



- Heater add-on for cold water pressure washers
- Effective heating of up to 10 GPM
- Heavy-duty, steel cabinet protected by an epoxy powder coat finish
- Flow switch for burner control
- Great for food processing, oil field and trucking applications

Model #	Part #	GPM	PSI	Electrical	Amps	BTU/Hour	Heated by	Ship Wt (lbs)
9450	1.103-905.0	10	3200	115V	8	700,000	Oil-Fired	525
9452	1.103-906.0	10	3200	115V	8	540,000	Natural-Gas-Fired	500
9460	1.103-907.0	10	3200	115V	8	920,000	Oil-Fired	920
9462	1.103-908.0	10	3200	115V	8	920,000	Natural-Gas-Fired	935

9450/9452 Series Dimensions: 32.5”L x 25”W x 50.5”H    9460/9462 Series Dimensions: 40.5”L x 32”W x 65”H

### Field Installed Options & Accessories

- 8.903-076.0 Natural-Gas to LP Conversion for Model 9452
- 8.903-075.0 Natural-Gas to LP Conversion for Model 9462
- 9.801-040.0 10” Natural Gas-Fired Draft Diverter for Model 9452
- 8.717-730.0 12” Natural Gas-Fired Draft Diverter for Model 9462
- 8.749-806.0 10” Power Dampener
- 8.753-171.0 12” Power Dampener
- 8.749-807.0 Power Dampener Wiring Harness

Factory Installed



# HD 7.9/72-4 Cage Ec



## Maximum power in a compact package.

The HD 7.9/72-4 Cage Ec ultra high pressure washer features one button operation and an automatic pressure relief valve, making it easy to use, while delivering the most powerful cleaning performance in its class for a variety of applications.



Built-in pressure relief valve reduces pressure in the hose, remaining flexible when the trigger gun is closed.  
 Pressure increases gradually when activating the trigger gun prevents sudden jolts.  
 Large wheels, crane hook and an optimal center of gravity ensure easy transportation, even over rough terrain.

Model #	Part #	PSI	GPM	Max Inlet Temp	Pump	Drive	Motor Rating	Ship Wt (lbs)
HD 7.9/72-4 Cage Ec	1.367-163.0	7200	7.9	140°F	Crankshaft	E-Motor 460 V / 60 Hz	30 kW / 41 HP	699

Dimensions: 51.9"L x 29.4"W x 43"H

### ACCESSORIES

Order No.	Description	Order No.	Description
<input checked="" type="checkbox"/> 4.775-824.0	Kärcher industry gun	<input type="checkbox"/> 6.415-060.0	F9 power rotary jet (7,200 PSI)
<input checked="" type="checkbox"/> 4.760-679.0	28" spray lance (up to 9,280 PSI)	<input type="checkbox"/> 6.025-526.0	F9 power rotary jet repair kit
<input checked="" type="checkbox"/> 6.391-847.0	66' pressure hose (up to 8,990 PSI)	<input type="checkbox"/> 6.025-233.0	Tool for changing rotor seat
<input checked="" type="checkbox"/> 5.765-263.0	Flat jet nozzle, 060	<input type="checkbox"/> 6.392-401.0	33' pipe cleaning hose
<input type="checkbox"/> 2.637-017.0	Add-on kit pre pressure pump	<input type="checkbox"/> 6.392-402.0	66' pipe cleaning hose
<input type="checkbox"/> 2.639-251.0	Shoulder support	<input type="checkbox"/> 6.392-403.0	100' pipe cleaning hose
<input type="checkbox"/> 4.760-653.0	41" spray lance (up to 9,280 PSI)	<input type="checkbox"/> 6.470-223.0	Foot valve
<input type="checkbox"/> 4.760-675.0	60" spray lance (up to 9,280 PSI)	<input type="checkbox"/> 6.025-527.0	Pipe cleaning nozzle, Standard 060
<input type="checkbox"/> 4.760-677.0	81" spray lance (up to 9,280 PSI)	<input type="checkbox"/> 6.025-528.0	Pipe cleaning nozzle, Quattro 060
<input type="checkbox"/> 4.403-004.0	Hose coupling	<input type="checkbox"/> 6.025-529.0	Pipe cleaning nozzle, Rotary 060
<input type="checkbox"/> 6.391-846.0	33' pressure hose (up to 8,990 PSI)	<input type="checkbox"/> 6.025-257.0	Mounting tool for nozzle kit
<input type="checkbox"/> 6.391-019.0	100' pressure hose (up to 8,990 PSI)	<input type="checkbox"/> 9.917-716.0	Abrasive blaster
<input type="checkbox"/> 2.113-073.0	Flat jet nozzle, 075 (5,075 PSI)	<input type="checkbox"/> 9.886-552.0	F98 3-nozzle kit for abrasive blaster
<input type="checkbox"/> 2.113-075.0	Flat jet nozzle, 095 (3,625 PSI)	<input type="checkbox"/> 6.025-308.0	Abrasive material hose
<input type="checkbox"/> 2.113-077.0	Flat jet nozzle, 120 (2,175 PSI)	<input type="checkbox"/> 6.025-258.0	Suction lance
<input type="checkbox"/> 5.765-264.0	Point jet nozzle, 060	<input type="checkbox"/> 5.401-325.0	Adapter M20 to UNF
<input type="checkbox"/> 2.113-074.0	Point jet nozzle, 075 (5,075 PSI)	<input type="checkbox"/> 2.643-577.0	FRI 50 Me industrial surface cleaner, 20" (7,200 PSI)
<input type="checkbox"/> 2.113-076.0	Point jet nozzle, 095 (3,625 PSI)	<input type="checkbox"/> 6.415-059.0	Nozzle kit for FRI 50 Me
<input type="checkbox"/> 2.113-078.0	Point jet nozzle, 120 (2,175 PSI)		

Included  Optional

# MWP Recovery



## Siphon muddy waters away

Stop wash water from flowing down a drain or away from your area by collecting the wastewater from pressure washing. As EPA laws become more prevalent and strive to conserve water quality, contract cleaners and construction sites will need to recover their wash water and runoff. Eliminate the problem with the MWP Recovery series which is capable of recovering and transferring up to 30 gpm of water and transferring to a holding tank. Its small footprint allows the MWP to be mounted on a trailer. Be fully in control of water flow with the optional water dikes and drain covers to stop water from flowing down a drain or away from your site. Comes standard with 50' feet of vacuum hose and a scupper head.



3 Stage Vacuum Motor delivers 100 CFM, 100" sealed lift vacuum with simple curbside controls for easy use  
 Rated for water up to 120°F and compatible with hot water machines  
 Bolt-on mounting system configured on the base to mount to a trailer for portability from site to site or optional caster wheel kit  
 Drain port and filter basket work together to keep sludge from clogging

Model #	Part #	Electrical	Amps	Tank	Vac Motor	Recovery	Ship Wt (lbs)
MWP-30E	1.103-518.0	120V	15	27 Gallon	3 Stage 100 CFM 100" Sealed Lift	30 gpm	127

Dimensions: 24"L x 27"W x 59"H

### Field Installed Options & Accessories

- 8.751-299.0 Mosmatic Surface Cleaner with Vacuum Port
- 8.928-887.0 Caster Wheel Kit
- 8.925-858.0 Vacuum Discharge Hose Kit

### Drain Covers and Water Dikes

- 8.751-135.0 Drain Cover, 36" x 36", 30oz PVC
- 8.751-136.0 Drain Cover, 48" x 48", 30oz PVC
- 8.751-137.0 Drain Cover, 48" x 48", Urethane
- 8.751-138.0 Water Dike, 10', 22oz PVC
- 8.751-139.0 Water Dike, 10', 40oz Urethane
- 8.751-140.0 Water Dike, 20', 22oz PVC
- 8.751-141.0 Water Dike, 20', 40oz Urethane

# KM 70/20 C



## Superior performance with manual power.

Speedy sweeping and painless maintenance rolled into one convenient package. These sweepers provides superior sweeping performance in a compact manual push sweeper. It is built to be rugged and durable for long life.



## Features

- Cleans paths, sidewalks and warehouses quickly and conveniently
- Main cylindrical brush is driven by both wheels so that it sweeps equally well in either right or left turns
- Rugged metal pinion drive for long life
- Durable design
- Height of cylindrical brush can be easily adjusted in five positions by a knob on the handle

### KM 70/20 C

#### Technical Specifications

Cleaning path / width - main broom	in	19
Cleaning path / width with 1 sb	in	28
Cleaning path / width with 2 sb	in	36
Side broom diameter	in	13
Debris container capacity	gal	11
Practical productivity	sq ft/hr	30,000
Weight	lbs	50.7
Dimensions (LxWxH)	in	51.2 x 30.14 x 40.7

#### EQUIPMENT

Part No.	Description
1.517-106.0	KM 70/20 C , twenty eight inch walk-behind sweeper
1.517-107.0	KM 70/20 C 2SB , thirty six inch push sweeper with dual brushes

#### ACCESSORIES

Order No.	Description
■ 6.966-005.0	Side broom, water-resistant bristles, extremely durable, suitable for all types of surfaces
■ 6.906-041.0	Main broom, water-resistant bristles, extremely durable, suitable for all types of surfaces
■ 4.040-772.0	Dust Filter
□ 2.640-908.0	Litter picker—for picking up waste

# KM 70/30 C BP ADV



## Efficient sweeping on hard or soft floors.

Fast and efficient for sweeping indoors or outdoors—on hard floor or carpet for those that need to get the job done right the first time. Rely on this sweeper to make quick work of any sweeping needs with its highly productive electronic driven broom. It also features active dust control for optimum air quality. User-friendly features such as an easy adjust broom height and an adjustable handle height make this a popular machine with those who use it.



## Features

- Delivers fast, efficient sweeping for hard and soft floor surfaces
- 28 inch cleaning path
- For a wide range of applications indoors and outdoors, with a particularly quiet battery drive system at 69 dBA
- Features Active Dust Control with a separate fan and flat pleated filter for dustless sweeping indoors
- Simple adjustment of the main cylindrical broom and side broom

### KM 70/30 C BP ADV

#### Technical Specifications

Cleaning path / width - main broom	in	19
Cleaning path / width with 1 sb	in	28
Side broom diameter	in	13
Debris container capacity	gal	11
Practical productivity	sq ft/hr	30,800
Operating noise level	dBa	69
Sweeping method	direct / overthrow	direct
Weight	lbs	105.8
Dimensions (LxWxH)	in	48.8 x 28 x 45.2

#### EQUIPMENT

Part No.	Description
1.517-218.0	KM 70/30 C BP ADV, twenty eight inch walk-behind sweeper

#### ACCESSORIES

Order No.	Description
■ 6.966-005.0	Side broom, water-resistant bristles, extremely durable, suitable for all types of surfaces
■ 6.906-041.0	Main broom, water-resistant bristles, extremely durable, suitable for all types of surfaces
■ 6.904-367.0	Flat dust filter
□ 2.640-908.0	Litter picker—for picking up waste
□ 5.731-625.0	Filter element - plastic filter, water resistant, washable, saves maintenance costs
□ 6.907-041.0	Standard cylindrical broom - water-resistant universal bristles, extremely durable, suitable for all types of surfaces



# KM 75/40 W Bp



## Self-propelled for increased productivity.

Big enough to get the job done, but maneuverable to clean congested areas, count on the KM 75/40 W Bp for your sweeping needs. This machine provides the versatility to clean anywhere—carpet or hard floors, indoors or out. We built it to perform day in and day out in the toughest commercial applications.



## Features

- Self-propelled, 30 inch cleaning path for increased productivity
- Easy to understand controls increase operator effectiveness
- Over throw sweeping system with an easily removed hopper to make emptying quick and efficient
- Air is vacuumed through a high-efficiency automotive style filter
- Manual filter shaker for easy cleaning and consistent results
- Wet-sweep bypass for cleaning wet surfaces



### KM 75/40 W BP

#### Technical Specifications

Cleaning path / width - main broom	in	22
Cleaning path / width with 1 sb	in	30
Side broom diameter	in	16.5
Debris container capacity	gal	10.5
Practical productivity	sq ft/hr	36,328
Operating noise level	dBa	64
Sweeping method	direct / overthrow	direct
Weight	lbs	172
Dimensions (LxWxH)	in	56 x 30 x 46.5

#### EQUIPMENT

Part No.	Description
9.840-739.0	KM 75/40 W Bp, thirty inch walk-behind sweeper

#### ACCESSORIES

Order No.	Description
■ 8.631-173.0	Battery, 12V AGM 70 Ah
■ 8.629-377.0	Automatic shelf charger, 24V, 24A, 115V, standard on AGM models
■ 6.905-626.0	Side Broom, KM Soft Bristle
■ 6.906-884.0	Main Broom, water-resistant bristles, extremely durable, suitable for all surfaces
■ 5.731-635.0	Flat pleated filter—plastic filter, water resistant, washable, reduces maintenance costs
□ 6.905-625.0	Side broom, hard for heavy-duty cleaning
□ 6.906-950.0	Anti-Static Rolling Brush
□ 2.641-571.0	Carpet Sweeping Kit (includes fluff filter, anti-static cylindrical brush and triple caster)
□ 6.906-886.0	Main cylindrical broom, soft/natural - specifically designed with natural bristles for sweeping fine dust on smooth indoor floors

# PUZZI™ 8/1 C



**Hand and compact for easy spot cleaning.**

The handy, compact and powerful Puzzi™ 8/1 C spray extraction cleaner is ideal for small areas and interim cleaning with excellent cleaning results.



## Features

- Foot switch makes it easy to turn on and off - no bending required
- Transparent dome lid for easy-to verify operation
- Swivel casters for easy maneuvering
- Lightweight - at only 19 lbs., it can be easily transported
- 8' high-pressure solution and vacuum hose
- Removable dirty water tank

### PUZZITM 8/1 C

#### Technical Specifications

<b>Solution / recovery capacity</b>	<b>gal</b>	2 / 1.8
<b>Operating noise level</b>	<b>dBa</b>	71
<b>Power cord length</b>	<b>ft</b>	33
<b>Vacuum</b>	<b>hp, stage</b>	1.5 hp
<b>Waterlift</b>	<b>in</b>	87
<b>Pump pressure</b>	<b>psi</b>	14.5
<b>Flow rate</b>	<b>gpm</b>	0.25
<b>Weight</b>	<b>lbs</b>	19.8
<b>Dimensions (LxWxH)</b>	<b>in</b>	20.8 x 13 x 17.3

#### EQUIPMENT

Part No.	Description
1.100-228.0	Puzzi™ 8/1 C , 98 inch spray hose with integrated water feed and hand tool

#### ACCESSORIES

Order No.	Description
■ 6.391-410.0	8-foot hose, complete with couplings
■ 4.130-116.0	4-inch upholstery hand tool
□ 4.130-127.0	Floor wand, 2-part with aluminum tube
□ 4.130-394.0	Floor wand, quick-action coupling, aluminum tube and metal nozzle
□ 4.762-220.0	Hard surface kit (attaches to 4.130-127.0 & 4.130-394.0 wands)
□ 2.638-778.0	Window cleaning kit with 6.5ft hose, (requires 2.389-293.0 coupler)
□ 4.130-083.0	Venetian blind kit (requires 6.389-293.0 coupler)
□ 4.130-128.0	Stair cleaning tool, 9-inch
□ 6.391-411.0	13-foot high pressure solution & vacuum hose
□ 4.130-117.0	Stone & hard surface nozzle
□ 4.762-219.0	Hard surface adapter for standard hand tool

# NT 25/1 AP



## Mobile, all-purpose vacuuming.

The NT 25/1 AP delivers powerful wet/dry cleaning in one compact package. This mobile all-purpose vacuum is easy and comfortable to transport to any job site. Designed for function, our vacuum features a light weight construction. Enjoy knowing that you can pick up anything wet or dry with this handy, practical machine.

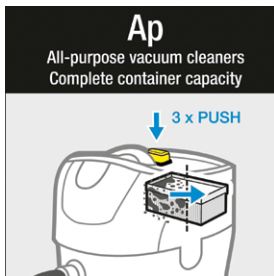

## Features

- Comfortable and easy to handle and on-board accessory storage
- Five caster wheel design provides superior movement and stability
- Complete accessory holder and cord hook
- Convenient additional storage area on the turbine head
- Mobile and lightweight, perfect for transport to multiple locations
- Easy, safe and quickly exchangeable clip hose connections
- Ergonomically designed hose for operator comfort

### NT 25/1 AP

#### Technical Specifications

Vacuum width, floor tool	in	11
Vacuum hose length	ft	8
Power cord length	ft	25
Waste container capacity	gal	6.6
Operating noise level	dBA	70
Air flow rate	cfm	123
Waterlift	in of water	88
Motor	watts	1,170
Weight	lbs	24
Dimensions (LxWxH)	in	20 x 14.5 x 19

#### EQUIPMENT

Part No.	Description
1.184-868.0	NT 25/1 AP, 6.6 gallon wet / dry vacuum

#### ACCESSORIES

Order No.	Description
■ 4.440-626.0	Suction hose C DN35
■ 6.906-240.0	Crevice nozzle DN35
■ 6.903-284.0	Floor tool DN35
■ 6.900-514.0	Suction tube DN35
■ 6.907-478.0	Set of filter bags - fleece 25L

# NT 30/1 Tact TE



## Stronger and sturdier than ever.

This powerful vacuum cleaner picks up coarse dirt and liquids as well as large quantities of fine dust. Tact, the fully automatic cleaning system, cleans the filter with strong air blasts. It is ideal for long periods of uninterrupted use and constant high suction power.



## Features

Blasts of air clean the filter resulting in lower maintenance costs and a longer filter life ultimately saving you money

On-board storage for all accessories, includes two hooks for the suction hose and power cord

Bayonet and clip connections guarantee easy and secure connection of all accessory parts onto machine

HEPA filter is standard

### NT 30/1 TACT TE

#### Technical Specifications

Vacuum width, floor tool	in	14
Vacuum hose length	ft	13
Power cord length	ft	25
Waste container capacity	gal	8.2
Operating noise level	dBa	68
Air flow rate	cfm	150
Waterlift	in of water	102
Motor	watts	1,380
Weight	lbs	30
Dimensions (LxWxH)	in	22 x 14.5 x 22.2

#### EQUIPMENT

Part No.	Description
1.148-216.0	NT 30/1 TACT TE, 8-gallon wet/dry vacuum with Tact

#### ACCESSORIES

Order No.	Description
■ 2.889-192.0	Stainless steel vacuum tube set
■ 2.889-135.0	Vacuum hose 13 ft
■ 2.889-134.0	Vacuum hose 8 ft
■ 2.889-170.0	Ergonomic bend
■ 2.889-152.0	Wet and dry floor nozzle
■ 2.889-159.0	Crevice nozzle
■ 2.889-151.0	Power tool adaptor
■ 2.889-154.0	Fleece filter bags - 30 liter
■ 6.907-629.0	HEPA filter



# NT 40/1 Tact TE



**Rugged dependability to get the job done.**

The NT 40/1 Tact Te has the power to get the job done. The motor of the machine has no carbon brushes—ideal for the rigors of industrial use. It features a life expectancy of over 5,000 hours.



## Features

- Large wheels and front swivel casters for easy maneuverability
- Self-cleaning filter with our Tact system
- Drain hose allows user to empty unit directly into a drain
- Metal wand, floor tool, crevice tool and washable nylon filter are included with each NT wet / dry vacuum.
- Crush resistant hose stows conveniently on top for storage
- HEPA filter is standard

### NT 40/1 TACT TE

#### Technical Specifications

Vacuum width, floor tool	in	14
Vacuum hose length	ft	13
Power cord length	ft	25
Waste container capacity	gal	10.3
Operating noise level	dBa	68
Air flow rate	cfm	150
Waterlift	in of water	102
Motor	watts	1,380
Weight	lbs	32
Dimensions (LxWxH)	in	22 x 14.5 x 25.7

#### EQUIPMENT

Part No.	Description
1.148-316.0	NT 40/1 Tact Te, 10-gallon wet/dry vacuum with Tact

#### ACCESSORIES

Order No.	Description
■ 2.889-192.0	Stainless steel vacuum tube set
■ 2.889-135.0	Vacuum hose 13 ft (Te versions)
■ 2.889-170.0	Ergonomic bend
■ 2.889-152.0	Wet and dry floor nozzle
■ 2.889-159.0	Crevice nozzle
■ 2.889-151.0	Power tool adaptor (Te versions)
■ 2.889-155.0	Fleece filter bags
■ 6.907-629.0	HEPA filter
■ 2.643-868.0	Push handle

# NT 50/1 Tact TE



**Fully compliant and easy to use.**

The NT 50/1 Tact Te includes an improved Tact automatic filter cleaning system - improved cleaning performance and reduced noise level. It is fully compliant with OSHA silica dust regulations.



## Features

- Bayonet and clip connections guarantee easy and secure connection of all accessory parts to the vacuum
- Self-cleaning filter with our Tact system
- Wider inner diameter of vacuum hoses (1-3/8 inches) is now standard
- Even stronger and sturdier components and overall design
- Crush resistant hose stows conveniently on top for storage

### NT 50/1 TACT TE

#### Technical Specifications

Vacuum width, floor tool	in	14
Vacuum hose length	ft	13
Power cord length	ft	25
Waste container capacity	gal	13.5
Operating noise level	dba	68
Air flow rate	cfm	150
Waterlift	in of water	102
Motor	watts	1,380
Weight	lbs	40
Dimensions (LxWxH)	in	22 x 14.5 x 41.1

#### EQUIPMENT

Part No.	Description
1.148-416.0	NT 50/1 Tact Te, 13.5-gallon wet/dry vacuum with Tact

#### ACCESSORIES

Order No.	Description
■ 2.889-192.0	Stainless steel vacuum tube set
■ 2.889-135.0	Vacuum hose 13 ft (Te versions)
■ 2.889-170.0	Ergonomic bend
■ 2.889-152.0	Wet and dry floor nozzle
■ 2.889-159.0	Crevice nozzle
■ 2.889-151.0	Power tool adaptor (Te versions)
■ 2.889-155.0	Fleece filter bags
■ 6.907-629.0	HEPA filter

See page 48 for optional accessory order numbers.

# NT 30/1, 40/1, 50/1 ACCESSORIES



**ACCESSORIES**

Order No.	Description
2.889-137.0	Vacuum hose 1-3/8 inch diameter (DN 35) 13 ft electrically conductive
2.889-136.0	Vacuum hose 1-3/8 inch diameter (DN 35) 8 ft electrically conductive
2.889-164.0	Vacuum hose 1-3/8 inch diameter (DN 35) 8 ft heat-resistant
2.889-172.0	Ergonomic bend 1-3/8 inch diameter (Dn 35) with soft grip electrically conductive
2.889-148.0	Ergonomic bend 1-3/8 inch diameter (DN 35) with soft grip and vacuum power regulation
6.907-455.0	Flat pleated filter PTFE
2.679-000.0	Drilling dust nozzle 1-3/8 inch diameter (DN 35)
2.643-868.0	Push handle for NT 40/1 Tact Te L
2.889-138.0	Vacuum hose 1-5/8 inch diameter (DN 40), 13 ft
2.889-139.0	Vacuum hose 1-5/8 inch diameter (DN 40), 8 ft
2.889-141.0	Vacuum hose 1-5/8 inch diameter (DN 40), 13 ft electrically conductive
2.889-140.0	Vacuum hose 1-5/8 inch diameter (DN 40), 13 ft oil-resistant
2.889-171.0	Ergonomic bend 1-5/8 inch diameter (DN 40), with soft grip
2.889-172.0	Ergonomic bend 1-5/8 inch diameter (DN 40), with soft grip electrically conductive
2.889-194.0	Set of vacuum tubes 1-5/8 inch diameter (DN 40), 2 x 1.8 ft, stainless steel
6.907-629.0	HEPA filter for NT 30/1, NT 40/1 and NT 50/1
2.889-174.0	Wide wet and dry floor nozzle with easily changeable inserts for wet/dry applications
5.032-427.0	Elbow Tube 40mm (for NT 65/2 Tact)
6.906-321.0	Suction hose 40 mm (for NT 65/2 Tact)
6.904-285.0	5 Pk Paper Filter Bags NT 65/2 (for NT 65/2 Tact)
6.907-276.0	Flat Pleated Filter (for NT 65/2 Tact)
6.904-364.0	HEPA Filter (for NT 65/2 Tact)
5.453-016.0	Power Tool Adapter 35mm Fem. thread - Bulk Pack (for NT 65/2 Tact)
6.900-275.0	Metal Suction Tube 40mm - Bulk Pack (for NT 65/2 Tact)
6.903-033.0	Crevice Tool 40mm - Bulk Pack (for NT 65/2 Tact)
2.639-873.0	Hose Coupler 40mm - Bulk Pack (for NT 65/2 Tact)
5.407-108.0	Reducer Sleeve 40mm to 35mm male thread Bulk Pack (for NT 65/2 Tact)
6.907-408.0	Floor Nozzle - 40mm - Bulk Pack (for NT 65/2 Tact)
5.453-042.0	(Photo 1 above) Power tool adapter, fits these size shrouds: 1.06" - 1.10" OD, 1.25" - 1.32" OD, 1.37" - 1.44" OD, 1.47" - 1.50" OD
5.453-016.0	(Photo 2 above) Power tool adapter, fits these size shrouds: 1.06" - 1.07" OD, 1.27" - 1.30" OD, 1.40" - 1.41" OD
5.407-108.0	(Photo 3 above) Power tool adapter: connects to 40mm hose connection, screws into 35mm hose or 5.453-016.0 tool adapter
2.637-217.0	(Photo 4 above) Power tool "Y" adapter
5.453-085.0	(Photo 5 above) Power tool adapter sleeve 40 x 50 mm
5.407-113.0	(Photo 6 above) Reducer, DN 40 to DN 35 hose connection
5.031-703.0	Tension ring (order with 5.407-113.0)

# NT 48/1



## A tough and versatile clean.

These machines are the tough and versatile wet/dry vacuums. Built to handle difficult wet or dry dirt, this vac is the machine that will stand up to tough everyday use. The optional front mounted squeegee provides even more productive water pickup. It is easy to transport from site to site with its large rear wheels and front casters as well as an easy to grip handle. The large filter provides impressive suction power and long work intervals improving your productivity.

## Features

- Mobile, all-purpose wet / dry vacuum for small to medium jobs and multiple locations
- Integrated handle ensures easy and comfortable transport
- Optional front mounted squeegee for more productive pickup

### NT 48/1

#### Technical Specifications

Vacuum width, floor tool	in	12
Vacuum hose length	ft	8
Power cord length	ft	25
Waste container capacity	gal	12
Operating noise level	dBa	72
Air flow rate	cfm	142
Waterlift	in of water	80
Motor	watts	1,380
Weight	lbs	22
Dimensions (LxWxH)	in	19 x 15.3 x 30.3

#### EQUIPMENT

Part No.	Description
1.428-623.0	NT 48/1, 13-gallon wet/dry vacuum

#### ACCESSORIES

Order No.	Description
6.414-789.0	Cylindrical Dust Filter
6.904-285.0	Paper filter bag (5-pack, 1 bag Included with machine)
6.906-512.0	All-Purpose Nozzle
6.900-385.0	8.3-inch all purpose crevice nozzle
4.440-626.0	8 feet x 1.375 inch hose with comfortable hand grip
6.900-514.0	Metal suction tube, 1.4 inch X 1.6 feet
6.906-240.0	Crevice nozzle, 1.4-inch
6.904-211.0	Wet Filter Bag
6.906-384.0	14.6" Aluminum All-Purpose Nozzle with Height-Adjustable Cylindricals, Brush Strips and Oil Resistant Squeegees
6.906-513.0	10.2-inch plastic all-purpose nozzle
6.906-554.0	14.2-inch plastic all-purpose head with cylindricals, brush strips and standard squeegee
6.906-383.0	17.7" Aluminum All-Purpose Head with Height-Adjustable cylindricals, Brush Stripes and oil-resistant Squeegees
2.860-113.0	Upholstery hand tool
2.860-114.0	10-inch turbo nozzle with reducer 35/32
6.903-033.0	11.4" Crevice Tool
6.900-233.0	4.7" Plastic Upholstery Nozzle, 35 mm ID
6.903-034.0	Radiator Brush for use with 6.900-385.0
6.903-035.0	Plastic, Pipe Diameter 3.9"
6.903-862.0	Suction Brush, Natural Hair, Pivotal, 35 mm ID
2.860-116.0	Nozzle Set, Crevice Tool, Upholstery Tool, Round Brush, 35 mm ID
2.863-147.0	All-Purpose Brush, Soft Bristles 35 mm ID
8.622-960.0	Replacement 15-inch squeegee blade



# NT 68/1



### Utility with ease.

Easily tackle medium to large jobs with this wet/dry vac. Designed with a robust 1.8 hp vac motor to handle any task you throw at it. If even more productivity is desired, the optional front mounted squeegee makes quick work of water recovery. Thoughtful features such as no-tipping dumping and on-board storage make this the operator's choice for wet/dry vacs.

### Features

- Optional front-mounted squeegee offers more productive water pick-up
- 18 gallon capacity offers easy mobility for medium to large jobs
- Easy to use, train and operate
- Complete with on-board tool storage compartment with safety sign storage bracket
- Self-adjusting squeegee assembly

#### NT 68/1

#### Technical Specifications

Vacuum width, floor tool	in	24.5
Power cord length	ft	50
Waste container capacity	gal	18
Operating noise level	dBA	71
Air flow rate	cfm	142
Waterlift	in of	80
Motor	watts	1,200
Weight	lbs	64
Dimensions (LxWxH)	in	35.5 x 24.5 x 37.5

#### EQUIPMENT

Part No.	Description
1.103-494.0	NT 68/1, eighteen gallon wet/dry vacuum with 24" front squeegee, with tools

#### ACCESSORIES

Order No.	Description
6.414-789.0	Cylindrical Dust Filter
6.904-285.0	Paper filter bag (5-pack, 1 bag Included with machine)
6.900-385.0	8.3-inch all purpose crevice nozzle
6.906-240.0	Crevice nozzle, 1.4-inch
6.906-384.0	14.6" Aluminum All-Purpose Nozzle with Height-Adjustable Cylindricals, Brush Strips and Oil Resistant Squeegees
6.906-513.0	10.2-inch plastic all-purpose nozzle
6.903-018.0	14.6" Aluminum All-Purpose Head with Height-Adjustable Cylindricals, Brush Stripes and squeegee blades
6.906-554.0	14.2-inch plastic all-purpose head with cylindricals, brush strips and standard squeegee
6.906-383.0	17.7" Aluminum all-purpose head with height-adjustable cylindricals, brush stripes and oil-resistant Squeegees
2.860-113.0	Upholstery hand tool
2.860-114.0	10-inch turbo nozzle with reducer 35/32
6.903-033.0	11.4" Crevice Tool
6.900-922.0	14.6" Crevice Nozzle, Metal
6.902-154.0	Wand
8.635-292.0	Front mount squeegee assembly
6.906-512.0	Squeegee head

# BR 35/12 C BP



**The race is always won in the corners.**

Thanks to our innovative steerable scrub deck, the BR 35/12 C Bp can clean up to the wall at a 90° angle. It can also clean in reverse, or in any direction. The height-adjustable, telescoping steering column allows optimal ergonomics for any operator. The folding steering column also makes it easy to secure for transport.



## Features

- Steerable scrub deck allows for scrubbing in any direction
- Brush height is adjustable for multiple floor types
- Eco!efficiency mode increases operating time by 50%, and reduces noise by 40%

### BR 35/12 C BP

#### Technical Specifications

Cleaning path / width	in	14
Brush type	cylindrical / disc / pad	Cylindrical
Brush quantity	units	1
Brush diameter	in	3.8
Suction bar (squeegee) width	in	18
Drive	pad-assist / traction	Brush-assist
Solution / recovery capacity	gal	3 / 3
Theoretical / practical productivity	sq. ft / hr	15,069 / 10,550
Operating noise level - std Eco! mode	dBa	66 / 62
Battery charger	shelf / on-board	On-board
Battery runtime	min	66-90
Battery charging time	hrs	1-3
Battery lifetime - est charging cycle	x thousands	3
Brush contact pressure	lbs	29
Brush speed	rpm	700-1,050
Vac motor rating	watts	280
Vac motor suction	cfm	42
Waterlift	in of water	32
Weight with batteries	lbs	77
Dimensions (LxWxH)	in	39 x 18 x 51

#### EQUIPMENT

Part No.	Description
1.783-454.0	BR 35/12 C BP, fourteen inch scrubber with cylindrical brushes

#### ACCESSORIES

Order No.	Description
4.037-031.0	Cylindrical Brush, red, medium
4.037-035.0	Squeegee blade set, standard, oil-resistant, polyurethane
6.654-294.0	Lithium-ion battery, 21 Ah
4.037-036.0	Cylindrical Brush, white, soft
4.037-037.0	Cylindrical Brush, orange, high/low
4.037-038.0	Cylindrical Brush, green, hard
4.037-039.0	Cylindrical Brush, black, very hard
4.762-009.0	Cylindrical Pad cylindrical shaft
6.369-053.0	Cylindrical Pads on sleeve, yellow, soft
6.369-047.0	Cylindrical Pads on sleeve, red, medium
6.369-052.0	Cylindrical Pads on sleeve, green, hard
4.037-040.0	Cylindrical microfiber pad, for daily cleaning of delicate surfaces including LVT and stone tile

# BD 38/12 C BP



## Steer your way to cleaner floors.

Think of the BD 38/12 as a 15 inch disc version of the popular BR 35/12. The design allows for the easiest driving of a walk-behind disk scrubber on the market. The squeegee follows behind the disc to ensure 100% solution pickup even through the corners.



## Features

- Agile for efficient cleaning of small and furnished areas
- Easy to use – scrub right up to the wall
- Quick charging lithium-ion battery
- Very compact, light and easy to transport and roll over steps.
- Reduced operating noise level for noise sensitive areas

### BR 35/12 C BP

#### Technical Specifications

Cleaning path / width	in	15
Brush type	cylindrical / disc / pad	Disc
Brush quantity	units	1
Brush diameter	in	15
Suction bar (squeegee) width	in	16
Drive	pad-assist / traction	Brush-assist
Solution / recovery capacity	gal	3.2 / 3.2
Theoretical / practical productivity	sq. ft / hr	16,360 / 12,270
Operating noise level - std / Eco! mode	dBA	65 / 62
Battery charger	shelf / on-board	On-board
Battery runtime	min	60-120
Battery charging time	hrs	2-3
Battery lifetime - est charging cycles	x thousands	3
Brush contact pressure	lbs	35-46
Brush speed	rpm	180 / 150
Vac motor rating	watts	280
Vac motor suction	cfm	42
Waterlift	in of water	32
Weight with batteries	lbs	79
Dimensions (LxWxH)	in	37 x 30 x 51

#### EQUIPMENT

Part No.	Description
1.783-431.0	BD 38/12 C, compact scrubber with fifteen inch disc brush

#### ACCESSORIES

Order No.	Description
■ 6.907-151.0	Disc brush, red
■ 6.654-294.0	Lithium-ion battery, 21 Ah
■ 4.037-059.0	Squeegee blades, made from transparent and oil-resistant polyurethane, includes front and rear blade
6.907-150.0	Pad driver plate
6.369-003.0	Red disc pads, set of 5
6.369-002.0	Green disc pads, medium soft, green, set of 5
6.369-001.0	Black disc pads, hard, set of 5
6.905-060.0	Disc microfiber pad, for daily cleaning of delicate surfaces including LVT and stone tile, set of 5

# BD 50/50 C BP



## Professional cleaning, now made easier.

This economically-designed scrubber provides you all the cleaning power to take on large jobs—perfect for retail environments, schools and health care facilities.

## Features

Three cleaning modes for any operator to get the job done right  
The slim design allows you to see in front of the scrubber easier  
Home Base kit allows for carrying essentials on the machines

### BD 50/50 C BP

#### Technical Specifications

Cleaning path / width	in	20
Brush type	cylindrical / disc / pad	Pad
Brush quantity	units	1
Brush diameter	in	20
Suction bar (squeegee) width	in	33
Drive	pad-assist / traction	Pad-assist
Solution / recovery capacity	gal	13.2 / 13.2
Theoretical / practical productivity	sq. ft / hr	13,200 / 9,900
Operating noise level - std / Eco! mode	dBa	66
Battery charger	shelf / on-board	Shelf
Brush contact pressure	lbs	59-62
Brush speed	rpm	180
Vac motor rating	watts	500
Vac motor suction	cfm	51
Waterlift	in of water	48
Weight with batteries	lbs	306
Dimensions (LxWxH)	in	47 x 21 x 39

#### EQUIPMENT

Part No.	Description
1.127-029.0	BD 50/50 C Classic BP, pad driver, 24V/105 Ah wet batteries
1.127-030.0	BD 50/50 C Classic BP, pad driver, 24V/100 Ah AGM batteries

#### ACCESSORIES

Order No.	Description
■ 4.762-534.0	Pad driver, 19 inch, features a quick-change coupling and centerlock (standard on pad driver machines)
■ 4.777-411.0	Curved squeegee, 33.5 inches, with caster, polyurethane
4.905-027.0	Disc brush, soft, made of natural fibers, for cleaning and polishing
4.905-029.0	Brush, hard black - For stubborn dirt and basic cleaning. For hard wearing surfaces.
4.905-026.0	Disc brush, medium grit, red, for general cleaning (standard on brush machines)
6.369-079.0	Red disc pad, 20-inch, medium soft red for cleaning all types of floors, 5-pack
6.369-078.0	Green disc pad, 20-inch, aggressive for cleaning heavily soiled floors and for deep cleaning, 5-pack
6.369-077.0	Black pad, 20-inch, hard, for cleaning heavily soiled floors and for deep cleaning, 5 pack
6.369-468.0	Beige disc pad, 20-inch, light grit, for polishing and refreshing of hard and elastic smooth floor coverings, 5 pack
6.371-146.0	Beige disc pad, 20 inch, soft, natural hair, for polishing
4.777-401.0	Squeegee, 33.5 inch, straight, made of oil-resistant transparent polyurethane, for smooth floors
5.035-488.0	Home Base kit (adapter and cable hook)
6.980-077.0	Double Hook (requires 5.035-488.0)
4.035-406.0	Home Base kit carrying case
6.980-078.0	Mopclip (requires 5.035-488.0)
6.980-080.0	Bottle Hook (requires 5.035-488.0)
4.070-075.0	Universal hook
8.641-483.0	Charger for wet batteries
8.629-377.0	Charger for AGM batteries



# B 40 C/W BP



We built this machine to be easy to operate, safe and easy to maintain. Our Kärcher Intelligent Key (KiK) and our advanced EASY operation are some of the many reasons why the B 40 C/W family offers a full spectrum of safety and protection for operators, machines and your floors.



## Features

- 100% control of the speed of your scrub brushes allows you to balance scrubbing power, noise levels and power consumption
- Choose disc and cylindrical decks from 17 to 22 inches
- Decks can be changed quickly and without tools
- The B 40 has six different cleaning modes so you can easily adjust the machine to fit the needs at any moment

	B 40 W DISC	B 40 W CYLINDRICAL	B 40 C DISC	B 40 C CYLINDRICAL
<b>Technical Specifications</b>				
Cleaning path / width	in 17-20	18-22	17-20	18-22
Brush type	cylindrical / disc / pad	disc	cylindrical	disc
Brush quantity	units 1	2	1	2
Brush diameter	in 17-20	3.75	17-20	3.75
Suction bar (squeegee) width	in 33.5	33.5	33.5	33.5
Drive	pad-assist / traction	traction	pad-assist	pad-assist
Solution / recovery capacity	gal 10.6 / 10.6	10.6 / 10.6	10.6 / 10.6	10.6 / 10.6
Theoretical productivity	sq. ft / hr 18,300-23,680	18,300-23,680	18,300 - 23,680	18,300 - 23,680
Operating noise level - std / Eco! mode	dba 60-69	60-69	60-69	60-69
Battery charger	shelf / on-board	on-board	on-board	on-board
Brush contact pressure	lbs 135-160	80-86	135-160	80-86
Brush speed	rpm 180	1,200	180	1,200
Drive / vac motor rating	watts 130 / 500	130 / 500	- / 500	- / 500
Vac motor suction	cfm 47	47	47	47
Waterlift	in of water 48	48	48	48
Weight with batteries	lbs 307-384	307-384	290-370	290-370
Dimensions (LxWxH)	in 49 x 20.5 x 45	49 x 20.5 x 45	49 x 20.5 x 45	49 x 21.1 x 45

EQUIPMENT	
Part No.	Description
9.841-122.0	B 40 W BP, traction drive, scrub deck sold separately, 24V/105 Ah batteries
9.841-123.0	B 40 W BP, traction drive, scrub deck sold separately, 24V/138 Ah AGM batteries
9.841-120.0	B 40 W BP, scrub deck sold separately, 24V/105 Ah batteries
9.841-121.0	B 40 W BP, scrub deck sold separately, 24V/138 Ah AGM batteries
9.841-372.0	B 40 W BP, traction drive, R 55 cylindrical scrub deck, 24V/105 Ah wet batteries
9.841-373.0	B 40 W BP, traction drive, D 51 disc scrub deck, 24V/105 Ah batteries
9.841-374.0	B 40 W BP, traction drive, R 55 cylindrical scrub deck, 24V/138 Ah AGM batteries
9.841-375.0	B 40 W BP, traction drive, D 51 disc scrub deck, 24V/138 Ah AGM batteries

# B 40 C/W BP Accessories

## ACCESSORIES

Order No.	Description
4.777-411.0	Curved squeegee assembly, 33.5 inches, with caster, polyurethane
5.035-488.0	Home Base kit (adapter and cable hook)
6.980-077.0	Double hook (requires 5.035-488.0)
5.035-344.0	Operator key, yellow
5.035-348.0	Foreman key, gray
4.035-369.0	Lid with tank rinsing system
4.035-345.0	Quick fill tank system (requires 9.083-003.0)
9.083-003.0	Hose coupling
6.273-207.0	Squeegee blade set, oil resistant (standard w/ 4.777-411.0)
6.273-229.0	Squeegee blade set, anti stripe oil resistant
6.273-290.0	Squeegee blade set, for textured floors
6.273-213.0	Squeegee blade set, EPDM
4.777-401.0	Squeegee assembly with straight polyurethane reversible blades
4.777-406.0	Squeegee assembly with straight EPDM blades
4.777-416.0	Squeegee assembly with curved EPDM blades
4.035-374.0	Home Base kit (includes mop support, mop clip and bottlehook)
4.035-406.0	Home Base kit carrying case
6.980-078.0	Mopclip (requires 5.035-488.0)
5.035-488.0	Mop support
5.035-656.0	Mop bracket (for mop support 5.035-655.0)
6.980-080.0	Bottle hook (requires 5.035-488.0)
4.035-408.0	Operator key, yellow, set of 5

See pages 62-65 for cleaning heads and brushes section for available scrub decks

## SERVICES

Order No.	Description
7.000-270.0	Fleet one year premium subscription

# B 60 W BP



**Efficient and quiet. Everything you need.**

The B 60 W Bp is the walk-behind scrubber built for efficiency from the ground up. Accomplish more with the same size staff with the impressive productivity of this machine. Choose between cylindrical, disc or oscillating mechanics and various widths to suit your needs with our interchangeable scrub decks. The KiK system Choose setting for your operators with our innovative KiK key system.



## Features

100% control of the speed of your scrub brushes allows you to balance scrubbing power, noise levels and power consumption. Choose disc, cylindrical, or oscillating decks from 22-26 inches. Each can be changed quickly and without tools.

		B 60 W + R 55	B 60 W + D 55	B 60 W + R 65	B 60 W + D 65	B 60 W + S 65
<b>Technical Specifications</b>						
Cleaning path / width	in	22	22	26	26	26
Brush type	cylindrical / disc / pad	cylindrical	disc	cylindrical	disc	oscillating
Brush quantity	units	2	1	2	2	1
Suction bar (squeegee) width	in	33.5	33.5	37	37	33.5
Drive	pad-assist / traction	traction	traction	traction	traction	traction
Solution / recovery capacity	gal	16 / 16	16 / 16	16 / 16	16 / 16	16 / 16
Theoretical / practical productivity	sq. ft / hr	23,680 / 17,760	23,680 / 17,760	27,980 / 20,985	27,980 / 20,985	23,680 / 17,760
Operating noise level	dBA	61-66	61-66	61-66	61-66	61-66
Battery charger	shelf / on-board	on-board	on-board	on-board	on-board	on-board
Brush contact pressure	lbs	193	92	193	95	78
Brush speed	rpm	600-1300	180	600-1300	180	2000
Drive / vac motor rating	watts	300 / 580	300 / 580	300 / 580	300 / 580	300 / 580
Vac motor suction	cfm	47	47	47	47	47
Waterlift	in of water	67	67	67	67	67
Weight with batteries	lbs	400	360	425	400	430
Dimensions (LxWxH)	in	59 x 26 x 45	58 x 26 x 45	60 x 29 x 45	60 x 29 x 45	57 x 28 x 45

## EQUIPMENT

Part No.	Description
9.841-171.0	B 60 W BP, scrub deck sold separately, 24V/245 Ah wet batteries, on-board charger
9.841-181.0	B 60 W BP, scrub deck sold separately, 24V/230 Ah AGM batteries, on-board charger
9.841-386.0	B 60 W BP, D 65 disc scrub deck, 24V/245 Ah wet batteries
9.841-387.0	B 60 W BP, D 65 disc scrub deck, 24V/230 Ah AGM batteries
9.841-172.0	B 60 W BP, R 65 cylindrical scrub deck, 24V/245 Ah batteries, on-board charger
9.841-173.0	B 60 W BP, R 65 cylindrical scrub deck, 24V/230 Ah AGM batteries, on-board charger
9.841-174.0	B 60 W BP, S 65 oscillating scrub deck, 24V/245 Ah batteries, on-board charger
9.841-175.0	B 60 W BP, S 65 oscillating scrub deck, 24V/230 Ah AGM batteries, on-board charger

# B 60 W BP Accessories

## ACCESSORIES

Order No.	Description
4.777-412.0	Squeegee assembly, 37-inch, curved polyurethane oil-resistant blades, standard on machines with R 75 & D 75 scrub decks
5.035-488.0	Home Base kit (adapter and cable hook)
6.980-077.0	Double hook (requires 5.035-488.0)
4.035-386.0	Lid with tank rinsing system
4.035-345.0	Quick fill tank system (requires 9.083-003.0)
9.083-003.0	Hose coupling
6.273-214.0	Squeegee blade set, blue EPDM
6.273-208.0	Squeegee blade set, oil resistant (standard w/ 4.777-412.0)
6.273-205.0	Squeegee blade set, anti stripe oil resistant
6.273-291.0	Squeegee blade set, for textured floors
4.035-472.0	New connection element for cylindrical brush heads, B 60 W
4.035-473.0	Accessory kit to use on B 60 head

See pages 62-65 for cleaning heads and brushes section for available scrub decks

## SERVICES

Order No.	Description
7.000-270.0	Fleet one year premium subscription



# B 80 W BP



**This large scrubber easily goes anywhere.**

The B 80 W BP scrubbers cover a lot of area quickly, but are still easily maneuverable. They feature a robust, interchangeable, maintenance-friendly scrub deck. Choose from cylindrical or disc in 22", 26", or 30" widths. Kärcher Fleet comes pre-installed on this machine to provide you with complete visibility of your machine.



## Features

- Decks automatically raise and lower as necessary
- Interchangeable decks changed quickly and without tools.
- Easily select your cleaning mode with the easy-to-read symbols on the large 4-color display

		B 80 W + R 65	B 80 W + R 75	B 80 W + D 65	B 80 W + D 75
<b>Technical Specifications</b>					
Cleaning path / width	in	26	30	26	30
Brush type	cylindrical / disc / pad	cylindrical	cylindrical	disc	disc
Brush quantity	units	2	2	2	2
Suction bar (squeegee) width	in	37	37	37	37
Drive	pad-assist / traction	traction	traction	traction	traction
Solution / recovery capacity	gal	21 / 21	21 / 21	21 / 21	21 / 21
Theoretical / practical productivity	sq. ft / hr	27,980 / 20,985	32,290 / 24,215	27,980 / 20,985	32,290 / 24,215
Operating noise level	dba	69	69	69	69
Battery charger	shelf / on-board	on-board	on-board	on-board	on-board
Brush contact pressure	lbs	213	213	117	136
Brush speed	rpm	400-1,550	400-1,550	180	180
Drive / vac motor rating	watts	350 / 580	350 / 580	350 / 580	350 / 580
Vac motor suction	cfm	53	53	53	53
Waterlift	in of water	67	67	67	67
Weight with batteries	lbs	282	284	289	293
Dimensions (LxWxH)	in	61 x 29 x 45	61 x 32 x 45	62 x 29 x 45	64 x 32 x 45

## EQUIPMENT

Part No.	Description
9.841-197.0	B 80 W Bp, scrub deck sold separately, 24V/225 Ah wet batteries, on-board charger, with curved squeegee
9.841-202.0	B 80 W Bp, scrub deck sold separately, 24V/260 Ah wet batteries, on-board charger, with curved squeegee
-	B 80 W Bp, R 75 and D 75 decks are ordered separately, please see pages 80-83 for more information and pricing
9.841-196.0	B 80 W Bp, D 65 disc scrub deck, batteries and charger sold separately, with curved squeegee
9.841-195.0	B 80 W Bp, R 65 cylindrical scrub deck, batteries and charger sold separately, with curved squeegee
9.841-199.0	B 80 W Bp, Scrub deck sold separately, 24V/255 Ah AGM batteries, on-board charger, with curved squeegee
9.841-388.0	B 80 W Bp, D 65 disc scrub deck, 24V/225 Ah wet batteries
9.841-204.0	B 80 W Bp, D 65 disc scrub deck, 24V/260 Ah wet batteries, with curved squeegee
9.841-198.0	B 80 W Bp, R 65 cylindrical scrub deck, 24V/225 Ah wet batteries, on-board charger, with curved squeegee
9.841-200.0	B 80 W Bp, R 65 cylindrical scrub deck, 24V/255 Ah AGM batteries, on-board charger, with curved squeegee
9.841-201.0	B 80 W Bp, D 65 disc scrub deck, 24V/255 Ah AGM batteries, on-board charger, with curved squeegee
9.841-203.0	B 80 W Bp, R 65 cylindrical scrub deck, 24V/260 Ah wet batteries, on-board charger, with curved squeegee

# B 80 W BP Accessories

## ACCESSORIES

Order No.	Description
4.777-412.0	Squeegee assembly, 37-inch, curved polyurethane oil-resistant blades, standard on machines with R 75 & D 75 scrub decks
5.035-488.0	Home Base kit (adapter and cable hook)
6.980-077.0	Double hook (requires 5.035-488.0)
8.600-251.0	Cable asm, bat. Jumper x 15" (required w/ no battery units)
4.035-345.0	Quick fill tank system (requires 9.083-003.0)
9.083-003.0	Hose coupling
6.273-205.0	Squeegee blade set, anti stripe oil resistant
6.273-291.0	Squeegee blade set, for textured floors

See pages 62-65 for cleaning heads and brushes section for available scrub decks

## SERVICES

Order No.	Description
7.000-270.0	Fleet one year premium subscription

# BD 80/100 W BP Classic

Quality and durability in a cost effective package.

This economically-designed scrubber provides you all the cleaning power to take on large jobs – perfect for retail environments, grocery stores and BSC's.



## Features

- Storage compartment in the back for shelf charger and other accessories
- Perfect recovery in 180 degree turns
- An automatic brake is integrated into the transaxle and a cost effective, large aluminum brush deck is included

### BD 80/100 W BP CLASSIC

#### Technical Specifications

Cleaning path / width	in	32
Brush type	cylindrical / disc / pad	Pad
Brush quantity	units	2
Brush diameter	in	16
Suction bar (squeegee) width	in	46
Drive	pad-assist / traction	Traction
Solution / recovery capacity	gal	26.4 / 26.4
Theoretical / practical productivity	sq. ft / hr	35,200 / 26,400
Operating noise level	dBA	69
Battery charger	shelf / on-board	Shelf
Brush contact pressure	lbs	120 - 200
Brush speed	rpm	180
Vac motor rating	watts	600
Vac motor suction	cfm	53
Waterlift	in of water	67
Weight with batteries	lbs	650
Dimensions (LxWxH)	in	59 x 33 x 42

#### EQUIPMENT

Part No.	Description
9.841-456.0	BD 80/100 W Bp Classic, 295 Ah wet batteries, shelf charger
9.841-457.0	BD 80/100 W Bp Classic, 285 Ah AGM batteries, shelf charger

# BD 80/100 W BP Classic Accessories

## ACCESSORIES

Order No.	Description
4.762-591.0	Pad drive board (standard)
6.371-332.0	Pad, red, medium-soft (standard)
8.629-184.0	Battery, Discover - 6V/285 Ah AGM (standard with 9.841-457.0)
8.622-837.0	Battery, Trojan - 6V/271 Ah Wet (standard with 9.841-456.0)
8.643-373.0	Shelf charger for wet batteries (standard with 9.841-456.0)
8.643-374.0	Shelf charger for AGM batteries (standard with 9.841-457.0)
4.777-102.0	Squeegee, 1100 mm (standard with suction blades)
4.037-138.0	Suction blades, 1230 mm, blue (standard)
6.371-331.0	Pad, white, soft
6.371-333.0	Pad, green, medium-hard
6.371-334.0	Pad, black, hard
2.639-258.0	Surface preparation pad, brown, hard
6.371-022.0	Melamine pad, white/grey
4.905-000.0	Disc brush, red, medium
4.905-032.0	Disc brush, black, hard
4.905-031.0	Disc brush, natural, soft
4.905-030.0	Disc brush, white, very soft
4.037-140.0	Suction blades 1230 mm, transparent
6.980-078.0	Mop clip
6.999-113.0	Litter picker
4.039-271.0	Mop holder
4.035-406.0	Home-Base kit box
5.035-488.0	Home-Base adapter
6.980-077.0	Double hook
6.980-080.0	Bottle hook
9.753-088.0	Squeegee transport plate
2.644-140.0	Warning beacon add-on kit



# B 150 R BP



## Race into efficiency with the B 150.

The B 150 R can cover up to 64,580 ft<sup>2</sup>/hr making this one impressively productive scrubber. Although it can cover large areas quickly, we made sure that it has great visibility for safety. Our KIK operating system and the color coded controls make operation simple and intuitive. KIK allows managers to control what functions and settings their employees can use and adjust.



## Features

- Clean ramps with grades up to 18%
- Features a unique all-wheel brake system for safety
- Utilize the large color LCD screen to adjust everything to your needs including contact pressure, water volume, brush speed, etc.
- Auto tank-rinsing and auto-fill come standard to allow the operator to do other tasks while rinse and fill are taking place

		B 150 R + R 75	B 150 R + D 75	B 150 R + R 90	B 150 R + D 90
<b>Technical Specifications</b>					
Cleaning path / width	in	30	30	35	35
Brush type	cylindrical / disc / pad	cylindrical	disc	cylindrical	disc
Brush quantity	units	2	2	2	2
Brush diameter	in	3.5	7.5	3.5	17.7
Suction bar (squeegee) width	in	37	37	42	42
Drive	pad-assist / traction	traction	traction	traction	traction
Solution / recovery capacity	gal	40 / 40	40 / 40	40 / 40	40 / 40
Theoretical / practical productivity	sq. ft / hr	48,438 / 34,445	48,438 / 34,445	58,125 / 40,903	58,125 / 40,903
Operating noise level - std / Eco! mode	dba	64 / 67	64 / 67	64 / 67	64 / 67
Battery charger	shelf / on-board	shelf	shelf	shelf	shelf
Brush contact pressure	lbs	245	224	275	238
Brush speed	rpm	1,200	140	1,200	140
Drive / vac motor rating	watts	600 / 750	600 / 750	600 / 750	600 / 750
Vac motor suction	cfm	55	55	55	55
Waterlift	in of water	72	72	72	72
Weight without batteries	lbs	959-1,146	959-1,146	959-1,146	959-1,146
Dimensions (LxWxH)	in	65 x 31 x 56	65 x 31 x 56	65 x 31 x 56	65 x 31 x 56
Minimum turning radius	ft	2.9	2.9	2.9	2.9
Climbing ability - maximum slope	% grade	10	10	10	10
Max working speed working	mph	3.7	3.7	3.7	3.7

# B 150 R BP Accessories

## EQUIPMENT

Part No.	Description
9.841-286.0	B 150 R Bp, scrub deck sold separately, 36V/360 Ah batteries
9.841-287.0	B 150 R Bp 2SB, scrub deck sold separately, 36V/360 Ah batteries, dual side brushes
9.841-288.0	B 150 R Bp ADV, scrub deck sold separately, 36V/360 Ah batteries
9.841-289.0	B 150 R Bp 2SB ADV, scrub deck sold separately, 36V/360 Ah batteries, dual side brushes
9.841-290.0	B 150 R Bp, R 75 cylindrical scrub deck, 36V/360 Ah batteries
9.841-291.0	B 150 R Bp, R 75 cylindrical scrub deck, 36V/312 Ah AGM batteries
9.841-294.0	B 150 R Bp 2SB, R 75 cylindrical scrub deck, 36V/360 Ah batteries, dual side brushes.
9.841-295.0	B 150 R Bp 2SB, R 75 cylindrical scrub deck, 36V/312 Ah AGM batteries, dual side brushes.
9.841-292.0	B 150 R Bp, R 90 cylindrical scrub deck, 36V/360 Ah batteries.
9.841-293.0	B 150 R Bp, R 90 cylindrical scrub deck, 36V/312 Ah AGM batteries.
9.841-296.0	B 150 R Bp 2SB, R 90 cylindrical scrub deck, 36V/360 Ah batteries, dual side brushes.
9.841-297.0	B 150 R Bp 2SB, R 90 cylindrical scrub deck, 36V/312 Ah AGM batteries, dual side brushes.
9.841-367.0	B 150 R Bp, Scrub deck sold separately, 36V/312 Ah AGM batteries
9.841-368.0	B 150 R Bp 2SB, scrub deck sold separately, 36V/312 Ah AGM batteries, dual side brushes
9.841-365.0	B 150 R Bp ADV, scrub deck sold separately, 36V/312 Ah AGM batteries
9.841-366.0	B 150 R Bp 2SB ADV, scrub deck sold separately, 36V/312 Ah AGM batteries, dual side brushes

## ACCESSORIES

Order No.	Description
■ 4.777-412.0	Squeegee assembly, 37-inch, curved polyurethane oil-resistant blades, standard on machines with R 75 & D 75 scrub decks
■ 4.777-413.0	Squeegee assembly, 42-inch, curved polyurethane oil-resistant blades, standard on machines with R 90 & D 90 scrub decks
■ 8.622-842.0	6V/360 Ah wet batteries
■ 8.629-184.0	Battery, 6V/312 Ah AGM battery
■ 8.628-408.0	Battery charger, 36V, 36A, 115V. For use with 8.622-842.0
■ 8.600-015.0	AGM battery charger, 36V, 21A, 115V
2.642-058.0	Spray Suction Kit - for Cleaning Areas Not Easily Accessed by Machine (field installation required)
6.435-733.0	Non-marking rear wheel, for use on sensitive floors that mark easily (field installation required)
4.444-015.0	Suction hose accessories, for taking in water from corners (e.g. deep freezers)
4.035-516.0	360° Warning Beacon (field installation required)
4.777-402.0	37-inch straight squeegee assembly, for machines with R 75 scrub deck
4.777-403.0	42-inch straight squeegee assembly, for machines with R 90 scrub deck
6.273-215.0	Blue squeegee blade (2 required)
6.273-209.0	Brown, oil-resistant squeegee blade
6.273-206.0	Brown, streak-free, oil-resistant squeegee blade
2.641-811.0	Cleaning agent dosing system DS 3 - Can be directly connected to the main water supply; the fresh water tank is filled with the mixture of water and cleaning agent. Also in connection with the ABS filling system.
6.435-810.0	Front tires, traction - with V profile and tire compound with especially good traction properties. Oil-proof.
6.951-073.0	Replacement side broom, for use with R-type scrub decks (1-pack)

See pages 62-65 for cleaning heads and brushes section for available scrub decks

## SERVICES

Order No.	Description
7.000-270.0	Fleet one year premium subscription

# Cleaning Heads: B 40, 60, 80 W BP and B 150 R BP

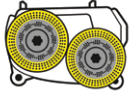

D-Series  
Disc Heads

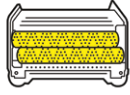

R-Series  
Cylindrical Heads

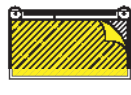

S-Series  
Vibration Heads

We offer three different scrub decks to suit your unique needs. The three types R (cylindrical), D (disc) or S (vibration) each have their specific advantages. Disc decks are ideal for everyday scrubbing. Cylindrical heads are ideal for stubborn dirt or uneven surfaces. The S heads are very efficient at stripping of floors. No matter your need, Kärcher has you covered.

## D 43 | 17-INCH DISC SCRUB DECK

Order No.	Description	B 40	B 60	B 80	B 150
2.763-023.0	D 43 head, 17-inch scrub deck for all battery-powered B 40 units	■			
4.762-533.0	Pad driver	■			
6.905-526.0	Disc microfiber pad, for daily cleaning of delicate surfaces including LVT and stone tile	■			
4.905-023.0	Disc brush, natural fibers	■			
6.369-470.0	Disc pad, red (general purpose/standard)	■			
4.905-022.0	Red disc brush, 17-inch	■			
4.905-024.0	Disc brush, white 17-inch	■			
4.905-025.0	Disc brush, black 17-inch	■			
6.369-472.0	Disc pad green (aggressive)	■			
6.369-473.0	Disc pad black (very aggressive)	■			
6.369-469.0	Disc pad white (soft)	■			
6.371-081.0	Disc pad beige (light aggregate)	■			
6.371-149.0	Disc pad, natural	■			

## D 51 | 20-INCH DISC SCRUB DECK

Order No.	Description	B 40	B 60	B 80	B 150
2.763-026.0	D 51 head, 20" / 510mm Scrub Deck for all Battery-Powered B 40 units	■			
8.642-710.0	One time conversion kit, D 51 orbital head (for serial # 10358 and higher)*	■			
8.638-801.0	Assembly, Deck, D 51 orbital (replacement deck assembly)	■			
4.905-026.0	Disc brush, medium grit, red, for general cleaning (standard on brush machines)	■			
4.905-028.0	Disc brush, very soft, for cleaning sensitive floors and polishing, white	■			
4.905-029.0	Disc brush, hard, for stubborn dirt and deep cleaning. Only for hard-wearing surfaces, black	■			
4.905-027.0	Disc brush, soft, made of natural fibers, for cleaning and polishing	■			
4.762-534.0	Pad driver, 19 inch, features a quick-change coupling and centerlock (standard on pad driver machines)	■			
6.371-271.0	Disc microfiber pad, for daily cleaning of delicate surfaces including LVT and stone tile	■			
6.369-079.0	Red disc pad, 20-inch, medium soft red for cleaning all types of floors, 5-pack	■			
6.369-078.0	Green disc pad, 20-inch, aggressive for cleaning heavily soiled floors and for deep cleaning, 5-pack	■			
6.369-077.0	Black pad, 20-inch, hard, for cleaning heavily soiled floors and for deep cleaning, 5 pack	■			
6.369-468.0	Beige disc pad, 20-inch, light grit, for polishing and refreshing of hard and elastic smooth floor coverings, 5 pack	■			
6.371-146.0	Beige disc pad, 20 inch, soft, natural hair, for polishing	■			

\*For serial # 10357 and lower, part number 6.613-512.3 msut also be ordered

## D 55 | 22-INCH DISC SCRUB DECK

Order No.	Description	B 40	B 60	B 80	B 150
2.763-001.0	D 55 brush head, disc head, 22-inch		■		
4.905-015.0	Disc brush, white - soft		■		
4.905-016.0	Disc brush, natural bristles		■		
4.905-014.0	Disc brush, red, standard with D 55 head		■		
4.905-017.0	Disc brush, black - very aggressive		■		
4.762-445.0	Pad driver		■		
6.371-153.0	Disc pad, red (soft)		■		
6.371-154.0	Disc pad, green (medium)		■		
6.371-155.0	Disc pad, black (hard)		■		

# Cleaning Heads: B 40, 60, 80 W BP and B 150 R BP

## D 65 | 26-INCH DISC SCRUB DECK

Order No.	Description	B 40	B 60	B 80	B 150
2.763-003.0	D 65 brush head, disc head, 26-inch		■	■	
4.905-011.0	Disc brush, white - soft		■	■	
4.905-012.0	Disc brush, natural bristles		■	■	
4.905-010.0	Disc brush, red, standard with D 65 head		■	■	
4.905-013.0	Disc brush, black - very aggressive		■	■	
4.762-446.0	Pad driver		■	■	
6.369-003.0	Red disc pads, set of 5		■	■	
6.369-002.0	Green disc pads, medium soft, green, set of 5		■	■	
6.369-001.0	Black disc pads, hard, set of 5		■	■	
6.369-959.0	Disc microfiber pad, for daily cleaning of delicate surfaces including LVT and stone tile		■	■	

## D 75 | 30-INCH DISC SCRUB DECK

Order No.	Description	B 40	B 60	B 80	B 150
2.763-005.0	D 75 brush head, disc head, 30-inch			■	■
4.905-019.0	Disc brush, white - soft			■	■
4.905-020.0	Disc brush, natural bristles			■	■
4.905-018.0	Disc brush, red, standard with D 75 head			■	■
4.905-021.0	Disc brush, black - very aggressive			■	■
4.762-447.0	Pad driver			■	■
6.369-791.0	Disc pad, red (soft)			■	■
6.369-790.0	Disc pad, green (medium)			■	■
6.369-789.0	Disc pad, black (hard)			■	■
6.371-078.0	Disc microfiber pad, for daily cleaning of delicate surfaces including LVT and stone tile			■	■

## D 90 | 36-INCH DISC SCRUB DECK

Order No.	Description	B 40	B 60	B 80	B 150
2.763-008.0	D 90 brush head, disc, 36-inch				■
4.905-003.0	Disc brush, red, standard with D 90 head				■
4.905-004.0	Disc brush, natural bristles				■
4.905-005.0	Disc brush, white - soft				■
4.905-006.0	Disc brush, black - very aggressive				■
4.762-493.0	Pad driver				■
6.369-022.0	Disc pad, black - hard				■
6.369-023.0	Disc pad, green - medium				■
6.369-024.0	Disc pad, red - soft				■

## R 45 | 18-INCH CYLINDRICAL SCRUB DECK

Order No.	Description	B 40	B 60	B 80	B 150
2.763-020.0	R 45 head, 18-inch scrub deck for non-traction drive machines (for C Units)	■			
2.763-019.0	R 45 head, 18-inch scrub deck for traction drive machines (for W Units)	■			
4.762-392.0	Cylindrical red brush, medium stiff bristles for all-around cleaning on smooth and textured floors	■			
4.762-405.0	Cylindrical white brush, soft bristles for gentle cleaning on all-surface floors	■			
4.762-406.0	Cylindrical orange brush, high-low bristles for cleaning all grouted surface floors	■			
4.762-407.0	Cylindrical green brush, stiff bristles for aggressive cleaning on irregular surface floors	■			
4.762-408.0	Cylindrical black brush, extremely stiff bristles for stubborn dirt on rugged floors	■			
4.762-413.0	Cylindrical pad shaft (required for all brushes below)	■			
4.114-009.0	Cylindrical microfiber pad, for daily cleaning of delicate surfaces including LVT and stone tile	■			
6.367-105.0	Cylindrical pad, yellow (soft)	■			
6.367-107.0	Cylindrical pads, red, general purpose	■			
6.367-108.0	Cylindrical pad, white, (very soft) for high-gloss floors	■			
6.367-106.0	Cylindrical pad, green (hard & aggressive)	■			

# Cleaning Heads & Brushes

R 55   22-INCH CYLINDRICAL SCRUB DECK					
Order No.	Description	B 40	B 60	B 80	B 150
2.763-013.0	R 55 head, 22-inch scrub deck for non-traction drive machines (for B 40 C units)	■			
2.763-011.0	R 55 head, 22-inch scrub deck for traction drive machines (for B 40 W, B 60 & B 90 units)		■		
4.762-393.0	Cylindrical red brush, 22-inch, medium stiff bristles for all-around cleaning on smooth and textured floors	■			
4.762-409.0	Cylindrical white brush, 22-inch, soft	■			
4.762-410.0	Cylindrical orange brush, 22-inch, high/low bristles for uneven floors	■			
4.762-411.0	Cylindrical green brush, 22-inch, hard bristles	■			
4.762-412.0	Cylindrical brush black 22-inch	■			
4.762-415.0	Cylindrical pad shaft, 22-inch, 2 required	■			
8.635-692.0	Cylindrical, stripping 22-inch	■			
4.114-010.0	Cylindrical microfiber pad, 22-inch, for daily cleaning of delicate surfaces including LVT and stone tile	■			
6.369-732.0	Yellow pad, 22-inch				
6.369-734.0	Red pad, 22-inch, medium grit for all-around cleaning on smooth and textured floors	■			
6.369-735.0	White pad, includes sleeve, 22-inch	■			
6.369-733.0	Green pad, 22-inch	■			
2.763-002.0	R 55 head, cylindrical, 22-inch		■		
6.906-977.0	Cylindrical brush, white, soft		■		
6.907-413.0	Cylindrical brush, red, standard with R 55 head		■		
6.906-978.0	Cylindrical brush, orange, hi-lo grout brush		■		
6.906-979.0	Cylindrical brush, green, hard		■		
6.906-980.0	Cylindrical brush, black, very aggressive		■		
8.635-692.0	Cylindrical, stripping 22-inch		■		
4.762-432.0	Cylindrical brush, red (2 required)		■		
6.369-389.0	White cylindrical pad, extra soft, set of 20		■		
6.369-454.0	Yellow cylindrical pad, soft, set of 20		■		
6.369-455.0	Green cylindrical pad, hard, set of 20		■		
6.369-456.0	Red cylindrical pad, medium, set of 20		■		

R 65   26-INCH CYLINDRICAL SCRUB DECK					
Order No.	Description	B 40	B 60	B 80	B 150
2.763-004.0	R 65 brush head, cylindrical, 26-inch		■	■	
6.906-981.0	Cylindrical white brush, soft		■	■	
6.907-414.0	Cylindrical red brush		■	■	
6.906-982.0	Cylindrical orange brush, high-low for grout		■	■	
6.906-983.0	Cylindrical green brush, hard		■	■	
6.906-984.0	Cylindrical black brush, very aggressive		■	■	
4.762-433.0	Cylindrical Pad Shaft		■	■	
6.369-389.0	White cylindrical pad, extra soft, set of 20		■	■	
6.369-454.0	Yellow cylindrical pad, soft, set of 20		■	■	
6.369-455.0	Green cylindrical pad, hard, set of 20		■	■	
6.369-456.0	Red cylindrical pad, medium, set of 20		■	■	

R 75   30-INCH CYLINDRICAL SCRUB DECK					
Order No.	Description	B 40	B 60	B 80	B 150
2.763-006.0	R 75 brush head, cylindrical, 30-inch			■	■
6.906-985.0	Cylindrical brush, white, soft			■	■
6.907-415.0	Cylindrical brush, red, standard with R 75 head			■	■
6.906-986.0	Cylindrical brush, orange, hi-lo grout brush			■	■
6.906-987.0	Cylindrical brush, green, hard			■	■
6.906-988.0	Cylindrical brush, black, very aggressive			■	■
4.762-434.0	Cylindrical pad shaft			■	■
6.369-389.0	White cylindrical pad, extra soft, set of 20			■	■
6.369-454.0	Yellow cylindrical pad, soft, set of 20			■	■
6.369-455.0	Green cylindrical pad, hard, set of 20			■	■
6.369-456.0	Red cylindrical pad, medium, set of 20			■	■



# Cleaning Heads & Brushes

## R 90 | 36-INCH CYLINDRICAL SCRUB DECK

Order No.	Description	B 40	B 60	B 80	B 150
2.763-007.0	R 90 brush head, cylindrical, 36-inch				■
6.906-989.0	Cylindrical white brush, soft, 36-inch				■
6.907-377.0	Cylindrical red brush, 36-inch				■
6.906-990.0	Cylindrical orange brush, high-low for grout, 36-inch				■
6.906-991.0	Cylindrical green brush, hard, 36-inch				■
6.906-992.0	Cylindrical black brush, very aggressive, 36-inch				■
4.762-189.0	Cylindrical pad shaft				■
6.369-389.0	White cylindrical pad, extra soft, set of 20				■
6.369-454.0	Yellow cylindrical pad, soft, set of 20				■
6.369-455.0	Green cylindrical pad, hard, set of 20				■
6.369-456.0	Red cylindrical pad, medium, set of 20				■

## S 65 | 26-INCH VIBRATION SCRUB DECK

Order No.	Description	B 40	B 60	B 80	B 150
2.763-030.0	S 65 brush head, oscillating scrub deck, 26-inch		■	■	
4.036-063.0	S 65 orbital head connection kit, required for connecting S 65 orbital, B 60 and B 80 units (required)		■	■	
4.036-061.0	S 65 orbital head connection kit, required for connecting S 65 orbital, B 90 units (required)				
8.635-789.0	Pad, S 65 surface prep, package of 5		■	■	
8.635-788.0	Pad, S 65, red, package of 5		■	■	
8.635-836.0	Pad, S 65, white, package of 5		■	■	

# SG 4/4



**KILLS 99.999%\* BACTERIA WITHOUT CHEMICALS**

**CERTIFIED DISINFECTION**

\*According to prEN 15615, PVC floor, machine: SGV (floor nozzle), 30 cm/sec, 1 steam, 2 steam vacuum, level 3) Test agent: Enterococcus faecalis ATCC 10541. According to prEN 15615, PVC floor, machine: SG 4/4 (floor nozzle with handle), 30 cm/sec, steam pressure maximum, Vapourhydro minimum) Test agent: Enterococcus faecalis ATCC 10541.

## Hygienically clean without chemicals.

Time is money—particularly in commercial cleaning. The SG 4/4 steamer has an ingenious two-tank filling system allowing for continuous use. Steam cleaning can impressively remove up to 99.999% of bacteria without chemical. It is also ideal for cleaning kitchens and grout.



## Features

- Our unique two-tank system allows for continuous use
- Very little time is needed to heat up the unit
- Control the level of steam
- Switch to pressurized hot water to remove stubborn dirt
- Only water is used by the SG 4/4 to save you money and to improve the health of users and guests

### SG 4/4

#### Technical Specifications

Voltage	V	110
Steam temp / pressure	°F / psi	248 / 58
Tank capacity	gal	1.06
Cable length	in	24.5
Weight without accessories	lbs	17.6
Dimensions (LxWxH)	in	19 x 12.6 x 10.8

#### EQUIPMENT

Part No.	Description
1.092-805.0	SG 4/4, commercial steam cleaner
9.841-414.0	SG 4/4, commercial steam cleaner with transport cart

#### ACCESSORIES

Order No.	Description
■ 4.322-020.0	Steam Hose
■ 4.127-024.0	Extension Tube
■ 2.885-142.0	Floor Tool, 12.4"
■ 2.884-280.0	Hand Tool
■ 6.906-185.0	Floor Nozzle
■ 2.884-282.0	Power Nozzle
■ 2.884-281.0	Point Jet Nozzle
■ 4.013-030.0	Funnel
■ 2.863-058.0	Round Brush Set
4.130-115.0	Window Nozzle
6.273-140.0	Wiper Blade (window)
2.863-062.0	Wallpaper Stripper
2.863-270.0	Microfiber Sleeves for Hand Tool
2.863-171.0	Steam+Clean Microfiber Cloth Set for Bathrooms (Includes 4 different clothes)
2.863-172.0	Steam+Clean Microfiber Cloth Set for Kitchens (Includes 4 different clothes)
2.863-173.0	Steam+Clean Microfiber Velour Floor Cloth Set (Includes 2 cloths)
2.863-174.0	Steam+Clean Microfiber Velour Cloth Covers for the Hand Tool (Includes 2 cloths)
6.962-097.0	Filling Funnel
2.885-465.0	Floor Tool Replacement
6.962-239.0	Two Wheel Transport Cart

# SGV 6/5



## Hygiene, non-stop.

The easy-to-use SGV 6/5 steam vacuum cleaner offers hygienic cleanliness. A single machine that is a steam cleaner and wet vacuum cleaner in one. With EASY Operation switch, secure accessory integration and hand tool for controlling the steam/vacuum function.



## Features

- One easy-to-use switch controls all operation
- Self-explanatory symbols means less training required
- Our unique design allows you to refill the water while in use
- The Included hand tool features an adjustment knob that allows you to adjust the water/steam regulation and turn the vacuum on and off

### SGV 6/5

#### Technical Specifications

Voltage	V	110-120
Steam temp / pressure	°F / psi	327 / 87
Tank capacity	gal	1.3
Cable length	in	24.5
Weight without accessories	lbs	86
Dimensions (LxWxH)	in	25 x 19 x 38

#### EQUIPMENT

Part No.	Description
1.092-003.0	SGV 6/5, commercial steam cleaner and wet vacuum

#### ACCESSORIES

Order No.	Description
■ 2.863-011.0	Round brush set, 3 Brushes
■ 2.889-005.0	Floor Nozzle, 12 inches
■ 2.889-006.0	Brush strips for floor nozzle 2.889-005.0
■ 2.889-007.0	Rubber Strip, 12 inches for floor nozzle 2.889-005.0
■ 2.889-008.0	Hand Nozzle
■ 2.889-009.0	Brush Strip, 6 inches for hand nozzle 2.889-008.0
■ 2.889-010.0	Rubber Strip, 6 inches for hand nozzle 2.889-008.0
■ 2.889-011.0	Adapter
■ 2.889-028.0	Crevice Nozzle
■ 2.889-052.0	Adapter for attaching round brushes
■ 4.440-009.0	Steam suction hose
■ 2.889-004.0	Extension tube set
2.889-053.0	Triangular floor nozzle
2.863-007.0	Round brush stainless steel (very hard bristles) set, 3 Nozzles
2.863-008.0	Round Brass Brush (hard bristles) Set, 3 Nozzles
2.863-009.0	Pekalon round brush (medium-hard bristles) set

# SG1 C BP Gum Remover

Turn up the heat on gum removal.

The Kärcher SG1 Bp is a portable gum remover. Powered by a single lithium ion battery, this gum remover is quiet and offer up to 4 hours of uninterrupted operation. It removes gum in 4-6 seconds and is safe to use on stone, concrete and even carpet. Great for maintaining shopping malls, schools, train stations, airports, hotels, hospitals, restaurants and supermarkets.



## Features

- Low pressure fuel canisters are designed to ensure delivery of proper fuel volume and safe operation
- No cords ensures safety and convenience
- No harsh residue—safe on all surfaces

### SG1 C BP

#### Technical Specifications

Run time	hrs	4
Weight	lbs	11
Dimensions (LxWxH)	in	4.5 x 13 x 20.5

#### EQUIPMENT

Part No.	Description
1.013-104.0	SGV 6/5, backpack gum remover

#### ACCESSORIES

Order No.	Description
8.639-871.0	Service pack: 2 LPG cartridges, 4 bottles of solution and 2 black stainless steel brushes, 1 green brush. Expect 8-9 hours run time.
8.640-135.0	Stainless steel brushes: 2 pack replacement stainless steel brushes (black)
8.640-136.0	Polypropylene brushes: 2 pack polypropylene brushes (green), for carpet and material
8.638-579.0	12-Pack of gas bottles
8.638-580.0	24 liters of gum remover solution

# AB 84 CUL



**This air blower is easy to handle.**

Enjoy the convenience that the AB 84 CUL offers in this easily transportable three speed air blower. Time is king in the cleaning industry. If you have wet hard floors or carpet, rely on the AB 84 CUL to dry your facility faster so you can resume to business-as-usual sooner. This unit features transport wheels and an upright handle for easy transport from job to job. The powerful 3,000 cfm air movement promotes rapid drying in no time.



**Features**

- Upright handle and transport wheels for safety and convenience
- Three speeds of air movement for every type of job
- Maximum air movement of 3,000 cfm for rapid drying of carpeted and hard floors
- Sturdy four point motor mount to withstand heavy use and rough handling
- Built-in carpet clip for flood restoration jobs

**AB 84 CUL**

**Technical Specifications**

Air flow rate - level 1, 2, 3	cfm	3000 / 2500 / 2000
Fan speed - level 1, 2, 3	rpm	1600 / 1350 / 1050
Power cord length	ft	25
Motor rating	hp	0.5
Voltage	V	115
Weight	lbs	39
Dimensions (LxWxH)	in	22.8 x 16 x 21.5

**EQUIPMENT**

Part No.	Description
1.004-053.0	AB 84 CUL, three-speed commercial air blower with upright handle



# BV 11/1 HEPA



## Breathe easy with HEPA filtration.

The BV 11/1 HEPA is a portable back mounted vacuum great for increasing productivity, efficiency, while saving you money. Breathe easier with HEPA-level filtration standard on the productive BV 11/1 backpack vacuum. It is lightweight and has an ergonomic harness system, allowing the operator to move around quickly and easily for maximum productivity.



## Features

- HEPA filtration is now standard, providing optimum air quality by filtering with 99.9% effectiveness to 0.3 microns
- Vacuum hose is a top-mounted swivel design for left-hand and right-hand operation

### BV 11/1

#### Technical Specifications

Vacuum width, floor tool	in	13
Vacuum hose length	in	60
Power cord length	ft	50
Waste container capacity	qt	10
Operating noise level	dBa	67
Air flow rate	cfm	112
Waterlift	in of	104
Motor	watts	1,200
Weight	lbs	11
Dimensions (LxWxH)	in	8.5 x 8.8 x 23.7

#### EQUIPMENT

Part No.	Description
9.840-514.0	BV 11/1, 10-quart back pack vacuum

#### ACCESSORIES

Order No.	Description
8.619-894.0	Hose Assembly
8.628-666.0	Wand, 2 PC Aluminum Double Curve
8.619-884.0	Cloth bag for Vac Pac™
8.619-885.0	10-quart paper bags, 10-pack
8.619-887.0	Filter Dome
8.639-285.0	HEPA pleated filter (standard on HEPA model)
8.604-141.0	Vac Pac™ Tool Kit (#02293 crevice tool, #02083 dusting brush, #02084 upholstery tool, #02085 upholstery tool brush, #02086 extension tube)
9.840-632.0	Vac Pac™ 2-Piece Aluminum Wand
8.628-445.0	Tool, Carpet
8.628-444.0	Tool, Bristle Shod Dry Pick-Up
8.639-285.0	HEPA Pleated Filter for Vac Pac™ and BV 11/1
8.619-876.0	Vac Pac™ Crevice Tool
8.631-254.0	Harness Assembly for Vac Pac™ and BV 11/1

# CV 300



## The sanitary choice that lasts.

Kärcher's CV 300 dual-motor upright vacuum is designed to be simultaneously powerful, lightweight and easy to maneuver. Our 1,000 watt vacuum motors pick up more dirt in a single pass than their comparable single-motor counterparts while our patented filtration system filters out particulates and allergens down to 0.3 microns.



## Features

- CRI approved for cleaner, healthier carpets
- Indicator lights alert operator to shut down or blockage
- Innovative, articulating head for superior maneuverability
- Ergonomic carrying handle for easy transport
- Powerful dual motor upright vacuum
- High quality three step filtration for optimum air quality

### CV 300

#### Technical Specifications

Cleaning path	in	12
Productivity (practical)	ft <sup>2</sup> / hr	3,104
Power cord length	ft	40
Operating noise level	dB(A)	69.5
Air flow rate	cfm	102
Voltage	110V / 220V	110V
Motor	hp	0.24
Debris bag size	qt	3.7
Weight	lbs	17
Dimensions (LxWxH)	in	11 x 12 x 48

#### EQUIPMENT

Part No.	Description
1.012-059.0	CV 300, 120V/60 Hz

#### ACCESSORIES

Order No.	Description
■ 8.632-214.0	Filter, exhaust
■ 8.628-477.0	Filter, motor protection
■ 8.630-933.0	Vacuum fan exhaust filter
8.600-495.0	12-Inch replacement double row brush
8.628-479.0	3-Ply filter dust bags, 10-pack
8.633-398.0	Filter bag, package of 10
8.634-975.0	Tool, 20" extension tool
8.632-244.0	Tool, clips for tools, dark gray
8.632-245.0	Tool, crevice tool, dark gray
8.614-100.0	Dusting brush, dark gray
8.614-629.0	Upholstery nozzle, dark gray
8.604-147.0	Vacuum tools kit (crevice nozzle, upholstery nozzle, and mounting clip)

# EB 30/1



## The quick clean-up tool.

This ultra-quiet and compact sweeper is perfect for quick cleanups in busy and crowded areas. The rechargeable battery pack ensures safety by eliminating trip hazards. It's built to handle small cleaning jobs in professional working environments.

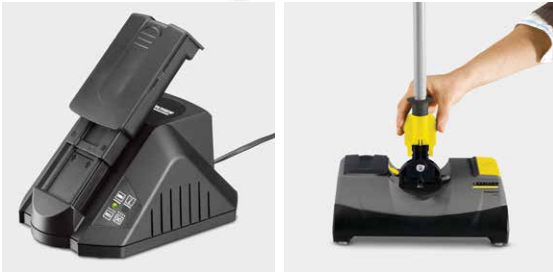

## Features

- Cordless electric sweeper designed for commercial applications
- Flexible and professional interim cleanup
- Powerful, rechargeable battery provides for up to 45 minutes of operation on hard surface, and up to 30 minutes on carpet
- Extremely quiet operation - for use in noise sensitive areas
- Innovative universal joint with parking position
- Large, non-marking soft grip wheels

### EB 30/1

#### Technical Specifications

Cleaning path	in	12
Container capacity	in <sup>2</sup>	67
Operating noise level	dBA	56
Battery runtime	min	40-60
Standard battery charge time	hr	5
Weight	lbs	6
Dimensions (LxWxH)	in	10 x 12 x 43

#### EQUIPMENT

Part No.	Description
1.545-121.0	EB 30/1, 12 inch, lithium-ion battery-operated sweeper

#### ACCESSORIES

Order No.	Description
■ 6.654-328.0	Lithium-ion battery for EB 30/1
■ 6.654-197.0	Battery charger
■ 4.762-400.0	Cylindrical brush
4.762-401.0	Cylindrical stiff red brush, for hard-wearing surfaces

# BDS 51/175 C



## Strong, solid and robust operation.

The BDS 51/175 C floor machine is a high quality, durable unit that offer powers and versatility for scrubbing and stripping. It features an adjustable handle to accommodate various user heights and five inch non-marking wheels to allow easy transportation. This machine is available in single-speed or dual-speed.



## Features

- Robust motor for everyday reliability
- Separate start and run capacitors for durability
- Cord strain relief to keep cord from breaking or tearing
- Strong and solid handle housing for trouble free operation

### BDS 51/175 C

#### Technical Specifications

Pad size	in	20
Pad speed	rpm	175
Theoretical / practical productivity	sq. ft / hr	2,222
Operating noise level	dBa	63
Voltage	V	115
Motor	hp	1.5
Wheel diameter	in	5 x 1.25
Power cord length	ft	50
Weight	lbs	118
Dimensions (LxWxH)	in	24.5 x 21 x 47

#### EQUIPMENT

Part No.	Description
9.841-423.0	BDS 51/175 C, twenty-inch

#### ACCESSORIES

Order No.	Description
8.628-430.0	Pad driver, 20-inch with clutch plate
8.600-062.0	Solution tank 4 gallon
8.600-507.0	Center lock
8.628-369.0	20-inch aggressive grit brush with clutch plate
8.628-378.0	20-inch mild grit brush with clutch plate
8.628-379.0	20-inch nylon polish brush with clutch plate
8.628-377.0	20-inch nylon scrub brush with clutch plate
8.628-370.0	20-inch polypropylene brush with clutch plate
8.625-259.0	20-inch sanding disc





# Detergents





## General Purpose

General Purpose Cleaners: General Purpose and Floor Cleaners. Designed for daily cleaning of facility surfaces, tools and floors.

Product Description	pH	Color	Scent	Dilution	Foam	Hardness 1-5	Phosphate Free	Size	Part #
General Purpose Cleaner	10.2	purple	slight	1 : 128	low	5		5 Gal	8.719-145.0
<p>General Purpose Cleaner is a blend of ingredients formulated to provide a low-foaming detergent for safe removal of dirt and grime off a broad range of surfaces. It is formulated to pass through a pressure washer without damaging the high-pressure pump. This formula is ideal for power washing around a home or shop, including exterior walls, decks, driveways, and roofs. It is also effective in cleaning machinery, equipment, cars, RVs, and trucks. It is safe for cleaning indoors or outdoors.</p>								55 Gal	8.906-714.0

## Automotive

Products designed specifically for soil conditions found on cars, vans and specifically vehicles with fine paint finishes. Effective and safe, phosphate free.

Product Description	pH	Color	Scent	Dilution	Foam	Hardness 1-5	Phosphate Free	Size	Part #
Auto Wash	10.2	purple	slight	1 : 128	low	5		5 Gal	8.698-185.0
<p>Auto Wash is a blend of ingredients formulated to provide a low-foaming detergent for safe removal of dirt and grime found on most vehicles. It is formulated to reduce water spots caused by hard water leaving a higher shine than most products. Auto Wash can pass through a pressure washer without damaging the high-pressure pump and is safe to use on aluminum, stainless steel, glass, plastic, paint and fine automotive finishes.</p>								55 Gal	8.698-186.0

## Vehicle

Detergent and care for both Automotive and Fleet use. Safe for both, non phosphate and superior results.

Product Description	pH	Color	Scent	Dilution	Foam	Hardness 1-5	Phosphate Free	Size	Part #
Vehicle Wash and Wax Detergent	12.9	blue-green	floral	1 : 150	high	5		5 Gal	8.698-172.0
<p>Vehicle Wash and Wax Detergent saves you time and money when you clean and protect in one step. Good for autos and trucks and safe on any finish. Superior performance in hard water leaving a shine with a spot free rinse.</p>								55 Gal	8.698-173.0
Vehicle Wax	5.3	straw	musk	1 : 2000	non-foaming	1		5 Gal	8.907-394.0
<p>Added at the final rinse, Vehicle Wax is a long-lasting liquid wax that creates a durable finish that improves a vehicle's appearance and helps keeps dirt from adhering to the surface. It gives added protection against salt, air pollution and acid rain and can be used safely on virtually every surface, including aluminum, stainless steel, glass, plastic, paint and fine automotive paint finishes.</p>									
Vehicle Pre-Soak	12.8	blue	citrus	1 : 60	high	4		5 Gal	8.698-223.0
<p>Vehicle Pre-Soak is used to remove stubborn soils like bugs, tar, oil and grease deposits on vehicles. It's applied before washing in order to penetrate and break up soils and washed away when the rest of the vehicle washing is done. The more time you allow to soak, the less scrubbing is required. Vehicle Pre-Soak is safe to use on fine auto finishes and strong enough to work on transportation fleet vehicles.</p>								55 Gal	8.698-224.0
Vehicle Tire and Rim Cleaner	12.9	colorless, detergent clear		RTU	high	3		12 x 1 Qt	8.698-226.0
<p>Vehicle Tire and Rim Cleaner is a fast and easy way to deep clean the black rubber, road film and brake dust soils from your tires and rims. Simply spray, wait and rinse. This product should be used to clean tire and wheels before adding tire dressing. Make tire dressings look better and last longer. Safe to use on all tires. Safe for steel and aluminum wheels, including coated wheels.</p>									

# DETERGENTS

## Fleet

Detergent and care for both Automotive and Fleet use. Safe for both, non phosphate and superior results.

Product Description	pH	Color	Scent	Dilution	Foam	Hardness 1-5	Phosphate Free	Size	Part #
Fleet Wash Detergent	12.9	green	fresh	1 : 150	high	5		5 Gal	8.698-168.0
Fleet Wash Detergent is a mild detergent designed for exterior cleaning of trucks, busses, equipment and implements. This special emulsifying formula contains high-powered cleaning agents that are effective on grease, road film and smoke trails. It is excellent as a pre-spray for cleaning engines, whitewall tires and vinyl and metal tops. Fleet Wash Detergent is phosphate-free and outperforms most competitive phosphate products. It is safe to use through a pressure washer. Fleet Wash Detergent can be used on polished aluminum, stainless steel, glass, plastic, and painted surfaces.								55 Gal	8.698-169.0
Heavy Equipment Detergent	12.9	green	fresh	1 : 150	high	5		5 Gal	8.698-189.0
Heavy Equipment Detergent is an effective, safe detergent that can be used on any surface. It is excellent as a pre-spray for softening and breaking up dried on or baked on soils like mud, bugs, greasy film, diesel fuel, lubricants. Excellent foaming capability. It is safe to use through a pressure washer and can be used on polished aluminum, stainless steel, glass, plastic, paint. Heavy Equipment Detergent is phosphate-free and outperforms most competitive phosphate products.								55 Gal	8.698-190.0
Fleet Wash Solvent Detergent	9.5	light yellow	citrus	1 : 50	medium	1		5 Gal	8.913-772.0
Fleet Wash Solvent Detergent adds the cleaning properties of solvents to boost cleaning capability in order to remove heavy, petroleum-based soils. Citrus-based solvent helps break down these tough soils for fast, efficient removal, saving time and energy. It has the ability to penetrate and break down baked-on hydrocarbon-based soils, like exhaust trails and carbonized grease, yet is safe on most surfaces.								55 Gal	8.913-773.0
Fleet Aluminum Brightener	< 1.0	colorless to light straw	sharp	1 : 5 1 : 20	low	2		5 Gal	8.907-711.0
Fleet Aluminum Brightener is an extra-strength, acid-based, aluminum cleaner and brightener designed for non-polished aluminum tanks and trailers, aluminum wheels and for preparing aluminum for painting. Do NOT use on glass, polished aluminum or anodized aluminum. Fleet Aluminum Brightener is effective in removing grease, oils, baked-on carbon and diesel smoke. This formula is non foaming.								55 Gal	8.907-712.0
Fleet Trailer Cleaner	1.1	straw	citrus	RTU	medium	4		5 Gal	8.698-174.0
Fleet Trailer Cleaner is a concentrated, non-etching, acid-based detergent formulated to quickly penetrate and remove grease, grime, dirt, road film and welding smut from polished aluminum and stainless steel surfaces. It shines aluminum and stainless by removing the oxidation that makes those surfaces dull looking.								55 Gal	8.698-175.0
Fleet Degreaser	13.5	red / orange	none	1 : 128	medium	5		5 Gal	8.698-166.0
Fleet Degreaser is a highly concentrated degreaser designed for petroleum based soils like heavy deposits of oil, grease and dirt as well as axle or fifth-wheel grease, hydraulic oils and diesel smoke stains. Fleet Degreaser is formulated to pass through a pressure washer without damaging the high-pressure pump and is, therefore, safe to use through a pressure washer. It is also safe to use on aluminum, stainless steel, glass, plastic, painted surfaces. Fleet Degreaser is phosphate-free and outperforms competitive phosphate formula products.								55 Gal	8.698-167.0

Product Description	pH	Color	Scent	Dilution	Foam	Hardness 1-5	Phosphate Free	Size	Part #
Fleet Interior Tank Cleaner	13.7	straw	slight	1 : 30	medium	4		5 Gal	8.914-094.0
<p>Fleet Interior Tank Cleaner is a highly concentrated and effective cleaner for the interior of tanks and vessels. Interior tank cleaning may or may not be accessible for manual brushing/scraping. This powerful formula can cut through many layers of soil with high pressure washing and soaking, eliminating the need to enter the tank. It is extremely effective in removing the most difficult-to-clean oil, grease and hydrocarbon-based deposits. It cuts grease, grime, oil, burnt carbon. Do not use on aluminum, magnesium, galvanized metal or fine painted surfaces. It is safe to use through a pressure washer and does not damage the high-pressure pump. This formula is phosphate-free and outperforms most competitive phosphate products.</p> <p>NSF Approved.</p>								55 Gal	8.914-096.0
Fleet Machine and Heavy Equipment Degreaser	13.3	brown	none	1 : 50	high	5		5 Gal	8.906-971.0
<p>Fleet Machine and Heavy Equipment Degreaser is an extra-strong cleaner that is ideal for cleaning heavy equipment, over-the road vehicles and off road machinery. It is especially effective cleaning exhaust stains, road grime and heavy deposits of dirt and oil. Fleet Machine and Heavy Equipment Degreaser is phosphate-free and outperforms competitive phosphate products. This powerful formula is not recommended for use on fine auto finishes, aluminum, magnesium and galvanized metal.</p>								55 Gal	8.906-979.0
Concrete Remover	2.2	light yellow	sharp	1 : 1	low	3		5 Gal	8.698-181.0
<p>Concrete Remover effectively removes concrete splatters and deposits from construction vehicles, equipment, tools and commercial surfaces. Not intended for use on fine automotive finishes. Always pre-test undiluted product in an inconspicuous area, to determine safety and suitability for the intended use.</p>								55 Gal	8.698-182.0
Salt and Ice Melt Remover	13.4	dark red	slight	1 : 100	high	5		5 Gal	8.698-183.0
<p>Salt and Ice Melt Remover is a combination detergent that removes heavy soil as well as all types of damaging road salt residue. Salt and Ice Melt Remover's unique chelating action breaks down the crystalline structure of ice melt salt and prevents it from crystallizing back on the surface so it can be easily rinsed away with the rest of the dirt. Effective on fine automotive finishes as well as construction equipment, trucks and fleet vehicles.</p>								55 Gal	8.698-184.0

## Quick Break Detergents

Products formulated for effective cleaning which separate quickly after washing in order to be accepted into on-site treatment systems.

Product Description	pH	Color	Scent	Dilution	Foam	Hardness 1-5	Phosphate Free	Size	Part #
Quick Release Detergent	12.8	none	slight	1 : 100	low	4		5 Gal	8.720-037.0
<p>Quick Release Detergent is concentrated heavy duty vehicle wash formulated to quickly and effectively remove dirt, grime, grease and road film from vehicles. It is ideal for vehicle wash facilities where it can be used on tractor-trailers, heavy equipment, RVs, trucks, and autos. Quick Release Detergent is formulated to pass through a pressure washer without damaging the high-pressure pump and has an oil-water quick-release surfactant making it ideally suited for use with water treatment systems.</p>								55 Gal	8.720-038.0

# DETERGENTS

## Degreasers

Degreasers are designed to be used on medium to heavy soils that require more aggressive formulation for built up greases and oils.

Product Description	pH	Color	Scent	Dilution	Foam	Hardness 1-5	Phosphate Free	Size	Part #
Chlorinated Degreaser	12.3	none	slight chlorine	1 : 60	high	4		5 Gal	8.698-203.0
Chlorinated Degreaser removes fats, oils and greases typically found in food service and food processing establishments. It's chlorinated formula breaks down stubborn protein soils that contribute to bio-film formation. This formula is safe on stainless steel, aluminum and painted surfaces. NSF Approved.								55 Gal	8.698-204.0
Heavy Duty Brown Degreaser	13.3	dark brown	none	1 : 50	high	5		5 Gal	8.698-201.0
Heavy Duty Brown Detergent is for cleaning machinery and equipment to remove heavy daily debris of oil, light grease, sand, mud and road film. This detergent is safe to use on most heavy equipment however, due to its strength to handle heavy soils, it should not be used on aluminum, magnesium or fine paint finishes.								55 Gal	8.698-202.0
Hood and Duct Degreaser	13.7	straw	slight	1 : 30	medium	4		5 Gal	8.698-205.0
Hood and Duct cleaner is specifically designed to remove the dangerous build-up of grease in exhaust hoods of food cooking establishments. Through a hot water pressure washer, fast effective removal restores hood and ducts to a clean, safe result. Even carbonized grease. Hood and duct cleaner can be used to pressure wash foodservice grills, fryers, broilers and ovens as well. Routine cleaning is required in most cities and states and also by the insurance industry. NSF Approved.								55 Gal	8.698-206.0

## Industrial

These are our most aggressive products designed to be used in industrial settings like production factories, mining, heavy construction and machine shops.

Product Description	pH	Color	Scent	Dilution	Foam	Hardness 1-5	Phosphate Free	Size	Part #
Heavy Duty Degreaser	13.3	red / orange	none	1 : 128	medium	5		5 Gal	8.907-304.0
Heavy Duty Degreaser is an industrial strength degreaser for cleaning heavy oils and greases, carbon, lubricants and hydraulic fluids found in industrial and manufacturing environments. Heavy Duty Degreaser is formulated to pass through a pressure washer without damaging the high-pressure pump or heating coil. It is also safe to use on aluminum, stainless steel, glass, plastic and concrete. Heavy Duty Degrease is phosphate-free and outperforms competitive phosphate formula products.								55 Gal	8.907-306.0
Industrial Grease and Carbon Remover	13.7	blue	none	1 : 100	high	5		5 Gal	8.906-942.0
Industrial Grease and Carbon Remover is heavy-duty degreaser that quickly penetrates and cleans grime, spent oil and grease in a variety of applications, including vehicles, equipment, RVs, drilling rigs, trucks and other structures. This highly-concentrated blend is formulated to wet, penetrate and suspend soil, oils and grease and yet is safe to use indoors or outdoors on virtually every surface, including aluminum, stainless steel, glass, plastic, and painted surfaces.								55 Gal	8.906-949.0
Industrial Oil and Grease Remover	12.3	yellow	citrus	1 : 150	high	5		5 Gal	8.698-193.0
Industrial Oil and Grease remover is designed to work on petroleum based oils and greases typically found in factories like cutting oils, lubricants and metal coatings. This product is designed to quickly break up the oils and suspend them in order to rinse easy and prevent them from re-depositing. The result is an oil/grease free surface. Industrial Oil and Grease Remover is engineered to pass through a pressure washer without damaging the high-pressure pump. It is safe to use on aluminum, stainless steel, concrete, glass, plastic and painted surfaces.								55 Gal	8.698-194.0

Product Description	pH	Color	Scent	Dilution	Foam	Hardness 1-5	Phosphate Free	Size	Part #
Metal Paint and Prep Phosphatizer	3.1	none	detergent solvent	1 : 512	low	5		5 Gal	8.914-472.0
<p>Metal Paint and Prep Phosphatizer is a complete and economical phosphatizing agent for the phosphatizing of iron and steel parts prior to painting. Effective in spray, dip and wipe-on applications. Metal Paint and Prep Phosphatizer works well in hard or soft water and rinses completely.</p>								55 Gal	8.914-484.0

## Building and Maintenance

Products specifically developed for use in building and tool maintenance. Safe to use on materials like brick, siding, stucco, concrete, tile.

Product Description	pH	Color	Scent	Dilution	Foam	Hardness 1-5	Phosphate Free	Size	Part #
Building Interior/Exterior Cleaner	10.2	purple	slight	1 : 130	low	5		5 Gal	8.698-170.0
<p>Building Interior/Exterior Cleaner is safe to use on aluminum, stainless steel, glass, plastic, paint, stone and masonry surfaces. Building Interior/Exterior Cleaner is ideal for power washing around a home or shop, including exterior walls, decks, driveways, and roof. This formula is phosphate-free and outperforms most competitive phosphate products.</p>								55 Gal	8.698-171.0
Concrete Cleaner	12.3	yellow	citrus	1 : 150	high	5		5 Gal	8.720-068.0
<p>Concrete Cleaner is formulated to clean stone and concrete surfaces. It is effective in removing oil, grease, baked-on carbon, tar and asphalt from unfinished concrete floors, walls and grout. Concrete Cleaner is engineered to pass through a pressure washer without damaging the high-pressure pump. It is safe to use on aluminum, stainless steel, glass, plastic and painted surfaces. This formula is phosphate-free and outperforms most competitive phosphate products.</p>								55 Gal	8.720-069.0
Brick & Masonry Graffiti Remover	12.8	yellow	slight solvent	1 : 16	low	1		4 x 1 Gal	8.698-033.0
<p>Brick, Masonry &amp; Concrete Cleaner re-liquefies and dissolves spray paint and marker tracks within seconds. No extended soak time is needed and it can be re-applied to wet surfaces as needed, without waiting for the surface to dry.</p>								12 x 1 Qt	8.698-034.0
Coil Descaler	1.0	white	slight solvent	1 : 16	high	5		12 x 2 lb	8.914-296.0
<p>Coil descaler quickly and safely removes hard water scale build up that robs the performance of your pressure washer. Removing the build-up improves the water flow, heat transfer while reducing strain on the pump.</p>									
Pump and Coil Protectant	7.3	amber	none	RTU	none	5		12x1 qt	8.698-058.0
<p>Pump and Coil Protectant is a multi-component product made from heat-resistant organic and inorganic salts. Its stabilizing action on the minerals which cause hardness in water, is based on its ability to impede the growth of mineral deposits. This product is proprietary to machines that have a built in dispenser for this product. Keeps your machine running efficiently with optimum performance and reliability.</p>								4 x 1 Gal	9.556-111.0
								5 Gal	9.556-011.0
Pump and Coil Protectant Concentrate	7.6	light brown	none	5 Gallons makes 55 Gallons	none	5		5 Gal	9.556-010.0



# DETERGENTS

## Floor Cleaners

Formulated for general purpose and heavy-duty floor cleaning. For use with floor care equipment (such as scrubbers) only.

Product Description	pH	Color	Scent	Dilution	Foam	Hardness 1-5	Phosphate Free	Size	Part #
Neutral Floor Cleaner	7.9	light yellow	solvent	1 : 128	low	4		4 x 1 Gal	8.698-209.0
Neutral Floor cleaner is formulated for everyday floor cleaning of resilient tile, hard finished floors, polished stone and polished concrete floors. No-rinse formula is designed to remove soil and leave a streak-free finish. Developed for scrubber machines, this formula is non-foaming, phosphate-free and contains ingredients that protect the machine from scale and contaminants.								5 Gal	8.698-210.0
								55 Gal	8.698-211.0
Shop Floor Cleaner	13.3	light red, clear	solvent	1 : 128	low	5		5 Gal	8.698-207.0
Shop Floor Cleaner is formulated for heavy-duty cleaning of soils typically found in machine shop environments. Lifts and removes petroleum-based grease and oily soils from all types of finished and unfinished concrete, including painted and epoxy-coated floors. No-rinse formula is designed to remove soil and leave a streak-free finish. Developed for scrubber machines, this formula is non-foaming, phosphate-free and contains ingredients that protect the machine from scale and contaminants.								55 Gal	8.698-208.0
Warehouse Floor Cleaner	12.9	blue	solvent	1 : 128	medium	5		5 Gal	8.698-212.0
Warehouse Floor Cleaner is formulated for everyday warehouse concrete floor cleaning. Use on finished or unfinished concrete. Safe for polished concrete floors. No-rinse formula is designed to remove dense concrete dust and leave a streak-free finish. Developed for scrubber machines, this formula is non-foaming, phosphate-free and contains ingredients that protect the machine from scale and contaminants.								55 Gal	8.698-213.0
								275 Gal	8.698-214.0

## Soft Floor Cleaners

Formulated for general purpose and heavy-duty soft floor cleaning. For use with floor care equipment only.

Product Description	pH	Color	Scent	Dilution	Foam	Hardness 1-5	Phosphate Free	Size	Part #
<b>CarpetExpert</b>									
Universal Spotter & Stain Remover (RM 769)			solvent	RTU				6 x 16 oz	9.808-011.0
Quickly remove solvent based spots and stains. Works on all soft coverings including carpet, upholstery and even hard floors. It removes oil, tar, shoe polish, grease, gum, permanent marker, adhesive and more from hard surfaces. Daily cleaning.									
iCapsol Cleaner (RM 768 OA)	8.5			1 : 16				1 x 2.5 Gal	6.296-026.0
Powerful dry foam carpet cleaner with odor eliminators. The encapsulation technology surrounds dirt and then dries for quick and easy removal with a vacuum. Interim cleaning.									
DriCapsol Cleaner (RM 766)	8.0							5 x 2.2 lbs Bags	9.808-012.0
For intermediate cleaning of soft floors. Cellulose fibers for cleaning deep into the pile and utilizes encapsulation to prevent resoiling. Quick drying formula. Interim cleaning.									
Tablet Extraction Cleaner (RM 760)	7.7			1 Tab / Gallon				20 Cartons	9.808-013.0
(16 count) Encapsulation technology integrated in extraction. One step process and woosafe. CRI approved. No need to pre-spray or rinse, allowing for quicker dry times. Next vacuum picks up any dirt left over.									

## DETERGENTS

Product Description	pH	Color	Scent	Dilution	Foam	Hardness 1-5	Phosphate Free	Size	Part #
<p>Tablet Extraction Cleaner (RM 760)</p> <p>(200 count) Encapsulation technology integrated in extraction. One step process and woolsafe. CRI approved. No need to pre-spray or rinse, allowing for quicker dry times. Next vacuum picks up any dirt left over.</p>	8.9			1 Tab / Gallon				1 Bucket	6.296-025.0
<p>Extraction Cleaner &amp; Pre-spray (RM 764)</p> <p>Ideal for deep cleaning spray extraction cleaners. Designed for all soft floors including mixed and fully synthetic fibers, upholstered furniture and soft wall surfaces. Restorative cleaning.</p>	9.2			1 : 128				1 x 2.5 Gal	6.296-027.0
<p>Neutral Extraction Cleaner (RM 767)</p> <p>Liquid neutral extraction cleaner for spray extraction for soft surfaces and upholstery eliminates unwanted odors and improves the hygiene of your soft floors. Daily cleaning.</p>	6.4			1 : 80				1 x 2.5 Gal	6.296-020.0
<p>Extraction Rinse (RM 763)</p> <p>Acid rinse that reduces rinsing time, removes dirt and residues, neutralizes the carpet and freshens its appearance. Restorative cleaning.</p>	3.8			1 : 128				2 x 1.25 Gal	9.808-015.0
<p>Recovery Foam Blocker (RM 761)</p> <p>Highly effective defoaming agent that helps reform foam in dirty water tanks. It's ideal for use in spray extractors, floor cleaning machines and wet / dry vacuum cleaners. Restorative cleaning.</p>			solvent	1 : 256				1 x 0.66 Gal	9.808-014.0
<b>Red Carpet</b>									
<p>Red Carpet Super Pre-Spray</p> <p>Pre-spray</p>				1 : 16				4 x 1 Gal	8.695-207.0
<p>Red Carpet Super Conditioning Rinse</p> <p>Conditioning rinse</p>				1 : 128				4 x 1 Gal	8.695-209.0
<p>Red Carpet Extraction Cleaner</p> <p>Extraction cleaner</p>				1 : 128				4 x 1 Gal	8.695-210.0
<p>Red Carpet Wool &amp; Natural Fiber Cleaner</p> <p>Wool and natural fiber cleaner</p>				1 : 128				4 x 1 Gal	8.695-211.0
<p>Red Carpet Liquid Defoamer</p> <p>Defoamer</p>				1 : 128				4 x 1 Gal	8.695-213.0
<p>Red Carpet Enzyme Deodorizer</p> <p>Enzyme deodorizer</p>				1 : 4				4 x 1 Gal	8.695-218.0
<p>Red Carpet Odor Neutralizer</p> <p>Odor neutralizer</p>		citrus		1 : 128				4 x 1 Gal	8.695-219.0
<p>Red Carpet Pro Spotter</p> <p>Spotter</p>				1 : 1				12 x 1 Qt	8.695-222.0
<p>2-Gallon Pump Sprayer with Wand</p> <p>Sprayer with wand</p>									8.628-441.0

# DETERGENTS

Product Description	pH	Color	Scent	Dilution	Foam	Hardness 1-5	Phosphate Free	Size	Part #
<b>iCapsol™ Encapsulating Chemical</b>									
ICapsol™ Encapsulating Chemical				1 : 16				4 x 1 Gal 12 x 1 Pt	8.695-226.0 8.695-496.0
ICapsol™ Encapsulator / Protector				1 : 16				4 x 1 Gal 12 x 1 Pt	8.695-227.0 8.695-470.0

## Miscellaneous

Product Description	pH	Color	Scent	Dilution	Foam	Hardness 1-5	Phosphate Free	Size	Part #
Vital Oxide	8.0	clear	none	RTU 1 : 5 1 : 9	medium	2		6 x 32 oz 4 x 1 Gal 55 Gal	8.639-560.0 8.639-558.0 8.698-112.0
<p>Vital Oxide is a hospital grade disinfectant sanitizer with 9 key attributes. Disinfection, Sanitizing, Odor Elimination, Carpet Sanitization, Allergen Removal, Kills Mold and Mildew, Kills biofilm, Parvo, Distemper, Tuberculous. Sanitizer dilution is NSF approved as a no rinse sanitizer for non-porous food contact surfaces. (US Only).</p>									
RM 99 Solar Cleaner	8.8	none	mild	1 : 100 1 : 200	low	4		5 Gal	8.698-094.0
<p>RM 99 Solar Cleaner is specific for cleaning solar and photovoltaic systems, and it's perfectly adapted to their unique surfaces. Its highly efficient, gentle on materials, biodegradable and removes even stubborn and greasy stains. It prevents the formation of limescale and maximizes the effectiveness of the system at minimum cost.</p>									
Gum Remover Detergents				1 : 1				20 x 90 ml	8.641-480.0
SG3 Bp chemical bottle									
Compass™ Clean				RTU				4 x 1 Gal	8.695-241.0
Food service cleaner / degreaser									
Compass™ Shine				RTU				4 x 1 Gal	8.695-242.0
Concentrated bathroom cleaner / deodorizer									
Compass™ Rinse								12 x 1 Qt	8.695-243.0
Spot free drying agent									



# Parts and Accessories

For a full list of available pressure washer parts and accessories, visit [www.landa.com](http://www.landa.com).



**Landa Water Jet Surface Cleaner**



Water Jet is the ultimate industrial surface cleaner on the market. It handles easier, cleans faster and holds up better under the toughest conditions. The Water Jet's spray bar spins at 2,000 RPM and can be adjusted to blast concrete but not dig up asphalt or wood. The rotating bar and shaft are made of stainless steel with sealed precision guide bearings for low maintenance and a long life. A holster-mounted trigger gun and insulated wand make for convenient spot cleaning in hard-to-reach places. Other features include:

- Rating: Super-duty
- Recommended Usage: Heavy
- Attaches to: Any hot or cold water pressure washer with minimum of 2000 PSI, 190°F
- Max PSI: 4000
- Max Temp: 200°F
- Cleaning Width: 20"
- Made of durable, rust-free polyethylene for easy handling, but weighs only 45 lbs
- Pneumatic tires on steel wheels make for easy maneuvering on all surfaces
- Easy-to-clean, in-line filter keeps spray nozzles from plugging
- Auto switching between surface cleaner and holster-mounted wand
- Trilingual warnings and operating instructions
- Collapsible handle for ease in transporting



- Fatigue-Free Trigger Handle:** Turns the unit off and on for operator safety.
- Tangle-Free Hose:** Swivel connection keeps hose from tangling while operating.
- Holster-Mounted Gun:** Keeps trigger gun close by for quick spot cleaning of hard-to-reach places.
- Variable Height Adjustment:** Allows you to raise or lower the spray bar so you can blast off concrete, but not dig up softer surfaces.
- Corrosion-Free:** Rotating bar and shaft are made of stainless steel with sealed precision guide bearing for low maintenance and long life; backed by 1-year warranty.
- Easy to Handle:** Swivel caster wheel, sealed for added protection against debris, makes for easy maneuvering into corners and tight spaces.
- Built to Last:** Self-lubricating rotary union is protected in a stainless steel housing and features industrial strength ball bearings and tungsten carbide seat for longer life.

Part #	Description
8.903-606.0	Water Jet Surface Cleaner
8.912-854.0	Spray Angle Adjustment Tool
8.707-011.0	Rotary Union
8.718-244.0	Actuator Valve Assembly
8.722-172.0	Repair Kit, Actuator Valve
8.711-289.0	8-Inch SS Spray Bar



**Landa Cyclone Surface Cleaner**



The economy model flat surface cleaner, Landa's Cyclone is the price-competitive surface cleaner with many of the same design features that have made the top-of-the-line Water Jet so popular. The Cyclone's non-adjustable spray bar spins at 2,000 RPM and seemingly glides across flat surfaces riding on the evenly balanced tubed pneumatic tires and swivel caster wheel. The rotating bar is made of stainless steel with medium-duty sealed precision guide bearings. Great for warehouse floors, sidewalks, pool decks, parking lots, and more.

- Durable, rust-free polyethylene spray housing
- Fatigue-free trigger handle turns unit on/off for operator safety
- Tangle-free hose connection for ease of maneuvering
- Trilingual operating instructions for added liability protection
- Collapsible handle for convenient storage



Part #	Description
8.903-608.0	Cyclone Surface Cleaner
8.751-358.0	Rotary Union (current style)
8.707-006.0	Rotary Union (old style - 2011 and prior)

- Rating: Heavy-duty
- Recommended Usage: Medium
- Attaches to: Any hot or cold water pressure washer with minimum of 2000 PSI, 190°F
- Max PSI: 4000
- Max Flow Rate: 6 GPM
- Max Temp: 200°F
- Cleaning Width: 20"
- Weight: 35 lbs

## EASY!Force Trigger gun – zero effort required!

Introducing the most effortless trigger gun on the market, the new Kärcher EASY!Force. The revolutionary EASY!Force trigger gun uses its own recoil force to hold the trigger down for you. This means no more sore hands after hours of use. Try our EASY!Force trigger gun – it is so much fun, you will not want to put it down!



**Ergonomics.** Our EASY!Force technology holds the trigger down once you start it, avoiding the strain on your hands associated with other trigger guns.

**Faster set-up.** The new EASY!Lock connection system allows set-ups that are five times faster than existing systems. A simple 360° turn provides a fully-threaded, secure connection.

**Designed for long life.** Our EASY!Force valve consists of a ceramic ball with ceramic sealing seat that is resistant to any particles liable to cause potential damage. This gives it a lifetime five times longer than trigger guns with conventional valve.

**Two versions.** Introducing the North American EASY!Force trigger gun with standard threads for Landa pressure washers and accessories, no adapters needed.

- **EASY!Force - North American Model.** Standard 1/4" connection for wand and 3/8" connection for hose. (NOT for use with EASY!Lock accessories) P/N 8.756-481.0
- **EASY!Force.** The EASY!Lock Threading for EASY!Lock adapters and accessories. (adapters not included) P/N 4.118-005.0

**Built in safety.** The trigger gun features a mechanical safety to prevent accidental starts for maximum safety without compromising its ease-of-use.

**Perfect connections.** The same quick locking, screw connection of EASY!Lock can be used on existing pressure washers and accessories. An easy system of adapters ensures compatibility is easy, and allows you to experience the power of the EASY!Force trigger gun. Contact your local dealer to find out more. Try our EASY!Force trigger gun – you won't want to put it down.



**EASY!FORCE TRIGGER GUN AND EASY!LOCK ACCESSORY SYSTEM**

**KÄRCHER**



NOTE: Accessories only compatible with EASY!Force Trigger Gun for EASY!Lock Threading.  
(Part # 4.118-005.0, shown above in Box 1)

	Part #	Description
EASY!Force trigger gun for EASY!Lock threading	1 4.118-005.0	Trigger gun uses the recoil force of the high-pressure spray to reduce the hold force of the trigger to zero
EASY!Force trigger gun repair kit	2 4.427-014.0	EASY!Force trigger gun repair kit: manifold complete with full ceramic valve
	3 2.885-483.0	EASY!Force trigger gun repair kit: spare part lever kit
Lance	4 4.112-000.0	41" spray lance; EASY!Lock threading
Lance repair kit	5 2.880-001.0	EASY!Force trigger gun repair kit: quad-ring sealing (3)
Side handle	6 4.321-380.0	Ergonomic handle that attaches to the spray lance and offers additional working positions
Power nozzle - spray angle 25°	7 2.113-004.0	Patented Kärcher power nozzle technology offers 40% increase in cleaning performance over conventional nozzles; engineered for EASY!Lock Size: 035
	8 2.113-023.0	Patented Kärcher power nozzle technology offers 40% increase in cleaning performance over conventional nozzles; engineered for EASY!Lock Size: 050
	9 2.113-014.0	Patented Kärcher power nozzle technology offers 40% increase in cleaning performance over conventional nozzles; engineered for EASY!Lock Size: 075
	10 2.113-017.0	Patented Kärcher power nozzle technology offers 40% increase in cleaning performance over conventional nozzles; engineered for EASY!Lock Size: 100
Hose	11 6.110-034.0	33' high-pressure hose for EASY!Lock threading
	12 6.110-033.0	50' high-pressure hose for EASY!Lock threading
Servo control	13 4.118-007.0	Pressure and water flow regulation directly at the EASY!Force trigger gun For 0-3.3 GPM
	14 4.118-008.0	Pressure and water flow regulation directly at the EASY!Force trigger gun For 3.3-4.9 GPM
	15 4.118-009.0	Pressure and water flow regulation directly at the EASY!Force trigger gun For 4.9 GPM
Adapter for EASY!Lock System	16 4.111-036.0	EASY!Lock - M 18 x 1.5: adapter for connecting spray lances with EASY!Lock and nozzles with M 18 x 1.5 connection; for use with iSolar
	17 4.111-041.0	EASY!Lock - STANDARD 3/8" HOSE: adapter for connecting EASY!Force trigger gun with standard 3/8" US-style hose connection
	18 4.111-042.0	EASY!Lock - STANDARD 3/8" MACHINE OUTLET: adapter for connecting high-pressure hoses with EASY!Lock and 3/8" US-style machine outlet

Only Compatible with EASY!Force Gun Part # 4.118-005.0

## ISOLAR 400/800 SOLAR PANEL CLEANER

**KÄRCHER**



### No place is unreachable.

The iSolar accessories system is a complete modular solution that offers all the necessary products for your cleaning needs, from water connections to brushes. This system is also compatible with many Kärcher pressure washers, meaning, existing pressure washers can usually be used to operate iSolar. Because the system is modular, we can build a custom solution to fulfill any requirement.

The iSolar 400 and iSolar 800 offer superior and safe cleaning, thanks to brushes powered by a pressure washer's water jet. The mechanical action of the bristles, made of nylon for scratch-free surface cleaning, operate at low pressure, eliminating any danger of the panels being damaged. The rotating brushes are also fitted with robust ball bearings to guarantee exceptionally long service life.



#### 1 iSolar 800

Counter-rotating disc brushes ensure:

- Excellent cleaning performance and area coverage
- Optimal handling with balancing of transverse forces
- Pre-rinsing of adjacent panels

#### 2 Comfortable in every position

Stable articulated joint offers:

- Convenient and flexible working positions
- Robust brass design for maximum durability

#### 3 iSolar 400

Entry-level model for smaller areas:

- Particularly suitable for elevated systems
- Pre-rinsing of adjacent panels

#### 4 Safety first

For safe rooftop work:

- Safety harness with quick-release fasteners
- Guided fall restorer with integrated shock absorber and lengthy guide rope

**ISOLAR 400/800 SOLAR PANEL CLEANER**

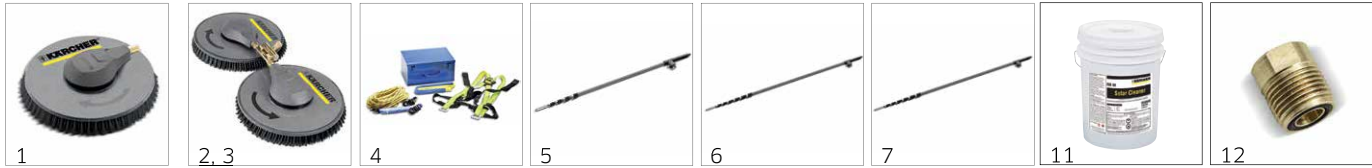

Product Description	Part #	Length	Flow Rate	Max Feed Temp
<p>iSolar 400</p> <p>The water-driven iSolar 400 disc brush features a working width of 400 mm (16") and is especially suitable for cleaning small to medium-sized photo-voltaic systems. Thanks to the low weight and easy handling, even elevated systems can be conveniently cleaned.</p>	1	6.368-457.0	4.85 - 5.72 GPM	104°F
<p>iSolar 800</p> <p>The water-driven iSolar 800 brush head with 800 mm (32") working width works with two contra-rotating disc brushes and is used for cleaning photo-voltaic systems. The contra-rotating brushes balance out all transversal forces, guaranteeing optimal handling. The flexible angle joint on the brush head's connector also makes cleaning easier. It ensures that the bristles always lie flat, allowing uniform cleaning results. The brush head features especially high area performance - ideal for cleaning large systems, for example on barn roofs.</p>	2	6.368-454.0	3.0 - 4.4 GPM	104°F
	3	6.368-455.0	> 4.84 GPM	104°F
<p>Safety kit</p> <p>Certified, standard-compliant safety system for safe working on roofs. The fall protection includes a traveling fall arrestor with shock absorber and 49.2 ft kernmantle rope, safety harness, an anchoring loop for fixing the safety machine, as well as a practical metal box for storage and transport</p>	4	6.988-152.0		
<p>iSolar TL 7 H (without hose, iSolar HP hose 7 required)</p> <p>Telescopic lance made from carbon/fiberglass mixture for maximum rigidity with minimum weight. With a 23.6 ft maximum reach and practical quick-release couplings for easy extension and retraction.</p>	5	4.107-054.0	5-23 ft.	140°F
<p>iSolar TL 10 C (without hose, iSolar HP hose 10 required)</p> <p>The telescopic lance is made from a carbon-fiberglass mixture (hybrid) and offers maximum rigidity with minimum weight. It has a reach of up to 32.8 ft and is fitted with practical quick-release couplings - for convenient extension and retraction. The speed is regulated via ball tap, guaranteeing easy handling. The carbon-fiberglass mixture is also on the lowest rod element and ensures electrical insulation and thus work safety.</p>	6	4.107-055.0	7-33 ft.	140°F
<p>iSolar TL 14 C (without hose, iSolar HP hose 14 required)</p> <p>The telescopic lance is made from a carbon-fiberglass mixture (hybrid) and offers maximum rigidity with minimum weight. It has a reach of up to 45.9 ft and is fitted with practical quick-release couplings - for convenient extension and retraction. The speed is regulated via ball tap, guaranteeing easy handling. The carbon-fiberglass mixture is also on the lowest rod element and ensures electrical insulation and thus work safety.</p>	7	4.107-052.0	7-45 ft.	140°F
<p>iSolar HP Hose 7</p> <p>The high-quality and flexible high-pressure hose with rubber outer covering is suitable for use in combination with the iSolar TL 7. The outer skin of the hose features especially good sliding properties - ideal for extending and retracting the telescopic lance.</p>	8	6.392-978.0	28 ft.	311°F
<p>iSolar HP Hose 10</p> <p>The high-quality and flexible high-pressure hose with rubber outer covering is suitable for use in combination with the iSolar TL 10. The outer skin of the hose features especially good sliding properties - ideal for extending and retracting the telescopic lance.</p>	9	6.392-977.0	38 ft.	311°F
<p>iSolar HP Hose 14</p> <p>The high-quality and flexible high-pressure hose with rubber outer covering is suitable for use in combination with the iSolar TL 14. The outer skin of the hose features especially good sliding properties - ideal for extending and retracting the telescopic lance.</p>	10	6.392-976.0	49 ft.	311°F
<p>RM 99 Solar Cleaner (5 gallon container)</p> <p>RM 99 Solar Cleaner is specific for cleaning solar and photovoltaic systems, and it's perfectly adapted to their unique surfaces. Its highly efficient, gentle on materials, biodegradable and removes even stubborn and greasy stains. It prevents the formation of limescale and maximizes the effectiveness of the system at minimum cost.</p>	11	8.698-094.0		
<p>Nozzle Adapter</p> <p>18 mm x 1/4" female. For connecting Kärcher nozzles to non-Kärcher lances.</p>	12	9.315-002.0		

Please note: not all accessories are compatible with EASY!Lock.

**Landa Industrial Sandblasters**

**LANDA®**

For the extra-tough cleaning jobs, wet-sandblasting is the dust-free solution. Landa's sandblasters attach to a hot or cold water pressure washer and, using a venturi, mixes sand or other abrasive media with the high-pressure spray to create enough cleaning power to strip paint off concrete and barnacles from a ship's hull. The sandblasting nozzle is made of tungsten carbide for long life. There are two models—a top-of-the-line steel pot with tight-fitting lid or with a probe only.

- Quick-connect coupler for ease in attaching sand probe or pot
- Valve for metering the flow of the media
- Tubed, pneumatic tires for easy maneuvering
- Rating: Super-duty
- Recommended Usage: Heavy
- Attaches to: Any hot or cold water pressure washer with minimum volume of 4 GPM



8.904-472.0



Sandblaster with Pot

Part #	Description
8.904-470.0	Sandblaster with Pot (Carbide)
8.904-472.0	Sandblaster with Probe (Carbide)

**Sandblast Hose**

**LANDA®**

Heavy-duty spiralite hose available preassembled or by the foot.



3/4" spiralite sand hose with air hose locking couplers  
-30°F to 130°F

Part #	Description	Size	Temperature
8.711-809.0	Sand, Spiralite /ft	3/4"	130°F
8.711-839.0	Assy, Sand, Spiralite	3/4" x 25'	130°F
8.711-840.0	Assy, Sand, Spiralite	3/4" x 40'	130°F
8.711-811.0	Sand, Spiralite /ft	1"	130°F

**Landa Sand Nozzle**

**LANDA®**

Tungsten Carbide provides maximum durability for sand blasting application.



Carbide insert  
Light weight  
Easily changed

Part #	Description
8.712-416.0	Carbide Sand Nozzle

**Steam Lance**

**LANDA®**

Designed for use with Landa's HOT3-3 Steamer unit. Completely insulated for maximum protection.



Lance with steam nozzle shown  
Vented grip full length of lance

Part #	Description
8.904-444.0	48" w/ Steam Nozzle
8.904-441.0	48" w/o Steam Nozzle



# LANDA PARTS & ACCESSORIES

## KNA EASY!Force Trigger Gun

**KÄRCHER**

The EASY!Force Trigger gun uses the recoil force of the high-pressure spray to reduce the hold force of the trigger to zero. The North American model features standard threads for Landa pressure washers and accessories, no adapters needed!



PSI: 4350  
 GPM: 7.5  
 Temperature: 311°F  
 3/8" FPT inlet x 1/4" FPT outlet

Part #	Description
8.756-481.0	KNA EASY!Force Trigger Gun
4.427-025.0	Repair Kit: Manifold Complete
2.885-483.0	Repair Kit: Spare Part Lever Kit

## Landa Gun

**LANDA®**

Designed exclusively for Landa to meet the demands of the high pressure cleaning professional.



PSI: 5000  
 GPM: 10.5  
 Temperature: 320°F  
 3/8" FPT inlet x 1/4" FPT outlet  
 Weight: 20 oz

Part #	Description
8.751-234.0	Landa Gun
8.751-119.0	Repair Kit

## Landa Variable Pressure Lances

**LANDA®**

The Landa Stainless Steel Variable Pressure Lance simply out-classes the competition. 41" length to meet ETL standards and 1/4" stainless steel tubes provide superior look and durability. Designed specifically for Landa to our specifications.



PSI: 4000  
 1/4" stainless or zinc plated tubes  
 Fully insulated  
 New improved brass valve body and stainless steel valve bushing

Part #	Description
8.711-308.0	Stainless Steel w/ Coupler
8.710-722.0	Stainless Steel Lance Only
8.711-293.0	Zinc Plated w/ Coupler
9.803-267.0	Repair Kit

## Cold Water Lances

**LANDA®**

Made of 304 stainless steel for long lasting durability. This 31" lance also has a highly visible yellow safety cover and coupler.



High visibility yellow protective cover  
 Stainless steel 1/4" pipe

Part #	Description
8.904-430.0	31" Covered w/ Coupler
8.904-437.0	42" Stainless Steel w/ Coupler
8.711-290.0	72" Stainless Steel

## Insulated Lances

**LANDA®**

Landa quality through and through. Superior heat protection with stainless steel tube construction. Available in stainless steel and zinc plated with vented grips or with molded plastic grip as shown below.



35.5" lance with vented grip and coupler, stainless steel shown  
 Vented insulated grip

Part #	Description
9.803-805.0	35.5" Lance w/ Coupler, SS
8.904-439.0	72" Lance w/ Coupler, Plated



**Landa High-Pressure Hose**



*For use with hot or cold-water pressure washers*

Introducing the new Landa hose. The Landa hose is built to exceed the EN1829-2 Standard and will provide superior abrasion resistance that will increase the life of the hose. The Landa hose is rated up to 250°F and is available in 4000 and 6000 PSI.

Both single- and double-wire braid hoses come with durable bend restrictors on both ends, with a 24-inch bend restrictor on the gun end for added operator protection against high-pressure bursts.

The Landa hose has a "bite-the-wire" coupling that grips the hose better than any other design.

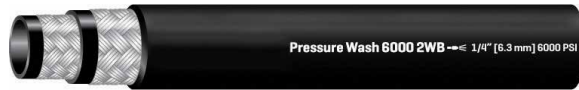

Temperature Rating: Landa hoses are rated for continuous temperatures up to 250°F.

Easily Identified: Permanently embossed identification makes for easy tracing and owner protection.

Certified Burst Protection: Landa hoses meet the stringent UL-1776 safety standards with two hose guards—including a 24-inch sleeve on the gun end—for added operator protection against bursts.

Unique Coupling: A "bite-the-wire" coupling actually reaches the wire braid for never-slip retention, far superior to the "compression" fittings used on conventional hoses.

**Landa 1-Wire Hose**



Landa branded black bend restrictor  
Smooth impression, oil resistant tube and cover with black hose guard, both ends  
Rated to 250°F

**Landa 2-Wire Hose**



Landa branded yellow bend restrictor  
Smooth impression, oil resistant tube and cover with yellow hose guard, both ends  
Rated to 250°F

Part #	Size	Temperature	PSI
<b>3/8" MPT Swivel x 3/8" MPT Solid, 3/8" ID</b>			
8.925-149.0	25' x 3/8" ID	250°F	4000
8.925-155.0	50' x 3/8" ID	250°F	4000
8.925-160.0	75' x 3/8" ID	250°F	4000
8.925-164.0	100' x 3/8" ID	250°F	4000
8.925-169.0	150' x 3/8" ID	250°F	4000
8.925-351.0	200' x 3/8" ID	250°F	4000
8.925-376.0	Case of 75 (of 8.925-155.0) - 3/8" x 50 ft Hoses		
8.925-445.0	Case of 40 (of 8.925-164.0) - 3/8" x 100 ft Hoses		

Part #	Size	Temperature	PSI
<b>3/8" MPT Swivel x 3/8" MPT Solid, 3/8" ID</b>			
8.925-179.0	25' x 3/8" ID	250°F	6000
8.925-183.0	50' x 3/8" ID	250°F	6000
8.925-224.0	75' x 3/8" ID	250°F	6000
8.925-228.0	100' x 3/8" ID	250°F	6000
8.925-231.0	150' x 3/8" ID	250°F	6000
8.925-370.0	200' x 3/8" ID	250°F	6000
8.925-380.0	Case of 75 (of 8.925-183.0) - 3/8" x 50 ft Hoses		
8.925-446.0	Case of 40 (of 8.925-228.0) - 3/8" x 100 ft Hoses		

Part #	Size	Temperature	PSI
<b>3/8" MPT Swivel x 3/8" MPT Solid, 1/2" ID</b>			
8.925-243.0	50' x 1/2" ID	250°F	5000
8.925-252.0	100' x 1/2" ID	250°F	5000

**Landa Hose Reels**



Fully-assembled and ready to use! Landa hose reels were designed for ease of use and durability in commercial pressure washer applications. Offering 100' and 200' reels in both a fixed base and 360 degree rotating base. The oversized reel holds the advertised length plus leaves additional space reducing the difficulty of reeling hose. The unique extended swivel improves the hose connection and reduces hose wear and stress.



Fixed Base Hose Reel



360° Pivot Reel

- 5000 PSI
- 325°F
- 100'- and 200'-fixed base
- 100'- and 200'-360° rotating base
- High-pressure, double-seal swivels
- Reels equipped for 3/8" hose. Easily convertible to 1/2" hose with the change to a 1/2" swivel
- 2-year warranty

Part #	Description
8.750-487.0	Pivot Reel - 100' x 3/8"
8.750-484.0	Pivot Reel - 200' x 3/8"
8.750-477.0	Non-Pivot Reel - 100' x 3/8"
8.750-480.0	Non-Pivot Reel - 200' x 3/8"

Note: Hose not included

Part #	Description
8.919-430.0	Universal Mount
8.919-794.0	Skid Mount
8.919-437.0	Wall Mount
8.919-434.0	Base Mount
8.919-072.0	Bracket, Universal
8.919-445.0	Bracket, 90-Degree
8.919-441.0	Bracket, 45-Degree
8.919-448.0	Bracket, Vertical

**Bracket Sockets**



Universal Mount



Skid Mount



Wall Mount



Base Mount

**Non-Pivot Reel Brackets**



Universal



90°



45°



Vertical

**Ready-Stack Hose Reels**

Patent-pending hose reels built specifically for contractors who require flexibility on a job site. Stackable reels are supported on both sides of the central hub to accommodate more aggressive applications, such as trailer-mounted.

\*Patent D739,715S and other Patents Pending



**200' Mild Steel Ready-Stack Hose Reel**



**100' Mild Steel Ready-Stack Hose Reel**



**Stainless Steel Ready-Stack Hose Reel**

Reel and swivel rated up to 6000 PSI and 350°F  
 Integrated frame adds protection and stacking ability  
 Accommodates hose lengths of up to 100' or 200'  
 Ideal for stacking on a trailer

Heavy-duty powder-coated steel or stainless steel  
 Modular design allows user to configure to meet various needs  
 Reversible hand-crank and swivel



**Hose Reel Riser**

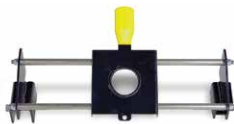

**Hose Guide**  
 directs hose back onto reel for a more uniform fit



**Reel Cart System**  
 helps to easily move multiple hoses and reels where needed



**Configured 200' Mild Steel Stackable Hose Reel with Optional Hose Guide and Hose Reel Riser**



**Configured 200' Mild Steel Stackable Hose Reels with Optional Reel Cart System and Hose Guide**

Part #	Description
9.801-771.0	100' Mild Steel Ready-Stack Hose Reel
9.801-772.0	200' Mild Steel Ready-Stack Hose Reel
9.801-773.0	100' Stainless Steel Ready-Stack Hose Reel
9.801-774.0	200' Stainless Steel Ready-Stack Hose Reel
8.923-415.0	Hose Guide, 100' Reel
8.923-427.0	Hose Guide, 200' Reel
8.923-416.0	Hose Reel Riser
8.923-918.0	Reel Cart System

Note: Hose not included

\*Patent D739,715S and other Patents Pending

**Landa G3 Pumps**

**LANDA®**



LX Series



The LX series pump is the patriarch of the line, delivering enough volume and pressure for the beefiest of pressure washer.

Up to 10.4 GPM and 3625 PSI  
10% lower RPM than comparable pumps

Extra-heavy-duty crankshaft and bearings  
10mm head bolts made of 12.9 class steel

Part #	Model #	GPM	PSI	RPM	Shaft
8.920-589.0	LX9536-Right	9.5	3625	1740	25mm
8.920-590.0	LX9536-Left	9.5	3625	1740	25mm
8.920-591.0	LX1036-Right	10.4	3625	1740	25mm
8.920-592.0	LX1036-Left	10.4	3625	1740	25mm



LT Series



Landa's unique design that delivers the same performance as other pumps but at 10% lower RPM.

Up to 6 GPM and 4000 PSI  
10% lower RPM than comparable pumps

Unique snug-fit design for heavy-duty valves  
Durable ceramic plunger with mirror finish

**LANDA®**

Part #	Model #	GPM	PSI	RPM	Shaft
8.921-710.0	LT4540-Right	4.5	4000	1360	25mm
8.921-711.0	LT4540-Left	4.5	4000	1360	25mm
8.921-712.0	LT6036-Right	6.0	3600	1450	25mm
8.921-713.0	LT6036-Left	6.0	3600	1450	25mm



LM Series



The LM series is a heavy-duty pump designed for a broad range of applications generally from 4 to 5 GPM and from 3000 to 3500 PSI.

Up to 5 GPM and 3500 PSI  
10% lower RPM than comparable pumps

Copper-plated plunger guide lined with low-friction, teflon bronze and lead bushing

**LANDA®**

Part #	Model #	GPM	PSI	RPM	Shaft
8.751-166.0	LM3540-Right	3.5	4000	1850	24mm
8.751-167.0	LM4030-Right	4.0	3000	1000	24mm
8.751-168.0	LM4030-Left	4.0	3000	1000	24mm
8.751-169.0	LM4035-Right	4.8	3500	1500	24mm
8.751-170.0	LM4035-Left	4.8	3500	1500	24mm
8.751-171.0	LM5030-Right	5.0	3000	1550	24mm
8.751-172.0	LM5030-Left	5.0	3000	1550	24mm
8.751-173.0	LM6035-Right	5.6	3500	1740	24mm
8.751-174.0	LM6035-Left	5.6	3500	1740	24mm



LS Series



The LS series is designed specifically as a direct-drive pump for gas engines.

Up to 5 GPM and 4000 PSI  
Durable ceramic plunger with mirror finish

Set screw for engine shaft

**LANDA®**

Part #	Model #	GPM	PSI	RPM	Shaft
8.751-175.0	LS3040G.3	3.0	4000	3400	1" Hollow
8.751-176.0	LS3540G.3	3.5	4000	3400	1" Hollow
8.751-177.0	LS4040G.3	4.0	4000	3400	1" Hollow

**LANDA®**

**Landa G3 Pumps**



Landa LF Series - Hollow shaft pumps for direct-drive electric units  
 Up to 3.5 GPM and 3000 PSI  
 Durable ceramic plunger with mirror finish

Part #	Model #	GPM	PSI	RPM	Shaft
8.923-762.0	LF2030F	2.1	3000	3450	5/8" Hollow
8.923-763.0	LF2030S	2.1	3000	1725	5/8" Hollow
8.923-764.0	LF2830F	2.8	3000	3450	5/8" Hollow
8.923-765.0	LF2830S	2.8	3000	1725	5/8" Hollow
8.923-766.0	LF3530F	3.5	3000	3450	3/4" Hollow



Landa LB Series - Solid shaft pumps for belt-drive units  
 Up to 4 GPM and up to 3000 PSI  
 Durable ceramic plunger with mirror finish

Part #	Model #	GPM	PSI	RPM	Shaft
8.923-753.0	LB3030-Right	3.0	3000	1650	24mm
8.923-754.0	LB3030-Left	3.0	3000	1650	24mm
8.923-755.0	LB4025-Right	4.0	2500	1550	24mm
8.923-756.0	LB4025-Left	4.0	2500	1550	24mm



Landa LP Series - Hollow shaft pumps for direct-drive gas units  
 Up to 3 GPM and up to 3500 PSI  
 Durable ceramic plunger with mirror finish

Part #	Model #	GPM	PSI	RPM	Shaft
8.923-757.0	LP2535G	2.5	3500	3400	3/4" Hollow
8.923-758.0	LP3035G	3.0	3500	3400	3/4" Hollow



Landa LP1 Series - Hollow shaft pumps for direct-drive gas units  
 Up to 4 GPM and up to 3500 PSI  
 Durable ceramic plunger with mirror finish

Part #	Model #	GPM	PSI	RPM	Shaft
8.923-759.0	LP3035G1	3.0	3500	3400	1" Hollow
8.923-760.0	LP3535G1	3.5	3500	3400	1" Hollow
8.923-761.0	LP4035G1	4.0	3500	3400	1" Hollow

**LANDA®**

**LANDA®**

**LANDA®**

**Ready Pumps**



Ready Pump assemblies are easy to install, less expensive than purchasing separate components, require less labor than assembling components, and eliminate the guesswork on selecting components to go with the pump.

Fully integrated pump setup includes a pump, unloader, thermal protector, bypass loop hose, garden hose inlet with filter, and quick connect coupler

VRT unloader valve  
 Available in direct and belt drive models

Part #	Model #	Type	GPM	PSI	RPM	Shaft	Unloader
8.924-440.0	LP3035G	Direct	3.0	3500	3400	3/4" Hollow	VRT3
8.924-441.0	LP3535G1	Direct	3.5	3500	3400	1" Hollow	VRT3
8.924-443.0	LB3030R	Belt	3.0	3000	1650	24mm Solid	VRT3
8.924-444.0	LM3540R.3	Belt	3.5	4000	1850	24mm Solid	VRT3
8.924-445.0	LM3840R.3	Belt	3.8	4000	1740	24mm Solid	VRT3

**LANDA®**



**Landa G3 Pump Repair Kits**



Original factory direct repair kits. See kit selection chart on the following page. Individual parts are also available.



Valve Kit



Seal Kit



Packing with Brass



Plunger Oil Seals



Ceramic Plunger Kit

Part #	Description
<b>Valve Kit</b>	
8.754-859.0	Valve Kit [LB, LF, LP, LP1 Series]
9.803-936.0	Valve Kit [LE, LD, LG Series]
9.802-603.0	Valve Kit [LM, LT, LS Series]
8.753-824.0	Valve Kit [LT Series]
9.802-604.0	Valve Kit [LX5050]
8.753-515.0	Valve Kit [LX5450 series]
9.802-608.0	Valve Kit [LX8030, LX1025]
8.752-853.0	Valve Kit, 22mm [LX series]
8.717-589.0	Valve Kit, 28mm [LX series]
<b>Seal Kit</b>	
8.754-860.0	Plunger Seals, 14mm [LF, LP, LP1 Series]
8.725-358.0	Plunger Seals, 15mm [LS Series]
8.725-354.0	Plunger Seals, 15mm [LE2020F, LE3525F, LD3030(H), LG Series]
8.754-856.0	Plunger Seals, 16mm [LB, LF Series]
8.753-512.0	Plunger Seals, 16mm [LX5450]
8.725-360.0	Plunger Seals, 18mm [LM4035]
8.753-821.0	Plunger Seals, 18mm [LT Series]
8.725-356.0	Plunger Seals, 18mm [LE2020S, LD4020]
8.725-362.0	Plunger Seals, 20mm [LM5030]
8.916-488.0	Plunger Seals, 20mm [LT Series]
8.916-487.0	Plunger Seals, 22mm [LT5030]
8.752-844.0	Plunger Seals, 22mm [LX Series]
8.725-364.0	Plunger Seals, 25mm [LX8030, LX1025]
8.752-845.0	Plunger Seals, 28mm [LX Series]
9.802-615.0	Plunger Seals [LX5050]
<b>Plunger Oil Seals</b>	
9.803-937.0	Plunger Oil Seals [LB, LD, LE, LF, LG, LP, LP1 Series]
9.802-609.0	Plunger Oil Seals [LM, LS Series]
9.802-606.0	Plunger Oil Seals [LT, LS Series]
8.752-835.0	Plunger Oil Seals [LT, LX, LX5450 Series]

Part #	Description
<b>Packing w/ Brass</b>	
8.754-861.0	Complete Seal Packing, 14mm [LF, LP, LP1 Series]
8.725-359.0	Complete Seal Packing, 15mm [LS Series, LM3540]
8.725-355.0	Complete Seal Packing, 15mm [LE2020F, LE3525F, LD3030H, LG Series]
8.754-857.0	Complete Seal Packing, 16mm [LB, LF Series]
8.753-513.0	Complete Seal Packing, 16mm [GX5450]
8.725-357.0	Complete Seal Packing, 18mm [LE2020S, LD4020]
8.725-361.0	Complete Seal Packing, 18mm [LM4035H]
8.753-822.0	Complete Seal Packing, 18mm [LT Series]
8.725-363.0	Complete Seal Packing, 20mm [LM4030, LM5030]
8.916-322.0	Complete Seal Packing, 20mm [LT Series]
8.916-323.0	Complete Seal Packing, 22mm [LT5030]
8.752-850.0	Complete Seal Packing, 22mm [LX Series]
8.725-365.0	Complete Seal Packing, 25mm [LX8030, LX1025]
8.752-851.0	Complete Seal Packing, 28mm [LX Series]
9.802-616.0	Complete Seal Packing [LX5050]
<b>Ceramic Plunger Kit*</b>	
8.754-862.0	Plunger, 14mm [LF, LP, LP1 Series]
9.803-934.0	Plunger, 15mm [LE2020F, LE3525F, LD3030H, LD3030, LG Series]
8.933-023.0	Plunger, 15mm [LS Series]
8.754-858.0	Plunger, 16mm [LB, LF Series]
8.753-514.0	Plunger, 16mm [LX5450]
8.753-823.0	Plunger, 18mm [LT Series]
8.751-237.0	Plunger, 18mm [LM4035, LX5050]
9.803-935.0	Plunger, 18mm [LE2020S, LD4020]
8.751-238.0	Plunger, 20mm [LM4030, LM5030]
9.802-607.0	Plunger, 20mm [LT4035]
9.802-611.0	Plunger, 22mm [LT5030]
8.752-839.0	Plunger, 22mm [LX Series]
9.802-614.0	Plunger, 25mm [LX8030, LX1025]
8.752-840.0	Plunger, 28mm [LX Series]

\*Includes bolt, washer, O-ring, teflon ring and ceramic plunger

**Landa G3 Pump Repair Kit Selection Chart**

Use the selection chart below to find the correct repair kits for the specific Landa Pump Model.

Pump Model	Valves	Seal Kits*	Packing w/Brass	Plunger Oil Seals	Ceramic Plunger Kit**
LB3030	8.754-859.0	8.754-856.0	8.754-857.0	9.803-937.0	8.754-858.0
LB3030R	8.754-859.0	8.754-856.0	8.754-857.0	9.803-937.0	8.754-858.0
LB4025	8.754-859.0	8.754-856.0	8.754-857.0	9.803-937.0	8.754-858.0
LD3025	9.803-936.0	8.725-356.0	8.725-357.0	9.803-937.0	9.803-935.0
LD3030	9.803-936.0	8.725-354.0	8.725-355.0	9.803-937.0	9.803-934.0
LD3030H	9.803-936.0	8.725-354.0	8.725-355.0	9.803-937.0	9.803-934.0
LD4020	9.803-936.0	8.725-356.0	8.725-357.0	9.803-937.0	9.803-935.0
LE2020F	9.803-936.0	8.725-354.0	8.725-355.0	9.803-937.0	9.803-934.0
LE2020S	9.803-936.0	8.725-356.0	8.725-357.0	9.803-937.0	9.803-935.0
LE2825F	9.803-936.0	8.725-354.0	8.725-355.0	9.803-937.0	9.803-934.0
LE2825S	9.803-936.0	8.725-356.0	8.725-357.0	9.803-937.0	9.803-935.0
LE3525F	9.803-936.0	8.725-354.0	8.725-355.0	9.803-937.0	9.803-934.0
LF2030F	8.754-859.0	8.754-860.0	8.754-861.0	9.803-937.0	8.754-862.0
LF2030S	8.754-859.0	8.754-856.0	8.754-857.0	9.803-937.0	8.754-858.0
LF2830F	8.754-859.0	8.754-860.0	8.754-861.0	9.803-937.0	8.754-862.0
LF2830S	8.754-859.0	8.754-856.0	8.754-857.0	9.803-937.0	8.754-858.0
LF3530F	8.754-859.0	8.754-860.0	8.754-861.0	9.803-937.0	8.754-862.0
LG2530G	9.803-936.0	8.725-354.0	8.725-355.0	9.803-937.0	9.803-934.0
LG3030G	9.803-936.0	8.725-354.0	8.725-355.0	9.803-937.0	9.803-934.0
LG3035G	9.803-936.0	8.725-354.0	8.725-355.0	9.803-937.0	9.803-934.0
LG3535G	9.803-936.0	8.725-354.0	8.725-355.0	9.803-937.0	9.803-934.0
LG4030G	9.803-936.0	8.725-354.0	8.725-355.0	9.803-937.0	9.803-934.0
LH5050	9.802-604.0	9.804-492.0	9.804-493.0	9.802-606.0	9.802-629.0
LM3540	9.802-603.0	8.725-358.0	8.725-359.0	9.802-609.0	8.933-023.0
LM3540R.3	9.802-603.0	8.725-358.0	8.725-359.0	9.802-609.0	8.933-023.0
LM3840R.3	9.802-603.0	8.725-358.0	8.725-359.0	9.802-609.0	8.933-023.0
LM4030	9.802-603.0	8.725-362.0	8.725-363.0	9.802-609.0	8.751-238.0
LM4035	9.802-603.0	8.725-360.0	8.725-361.0	9.802-609.0	8.751-237.0
LM4035H	9.802-603.0	8.725-360.0	8.725-361.0	9.802-609.0	8.751-237.0
LM5030	9.802-603.0	8.725-362.0	8.725-363.0	9.802-609.0	8.751-238.0
LM6035	9.802-603.0	8.725-360.0	8.725-361.0	9.802-609.0	8.751-237.0
LP2535G	8.754-859.0	8.754-860.0	8.754-861.0	9.803-937.0	8.754-862.0
LP3035G	8.754-859.0	8.754-860.0	8.754-861.0	9.803-937.0	8.754-862.0
LP3035G1	8.754-859.0	8.754-860.0	8.754-861.0	9.803-937.0	8.754-862.0
LP3535G1	8.754-859.0	8.754-860.0	8.754-861.0	9.803-937.0	8.754-862.0
LP4035G1	8.754-859.0	8.754-860.0	8.754-861.0	9.803-937.0	8.754-862.0
LS3040G.3	9.80-2603.0	8.725-358.0	8.725-359.0	9.802-609.0	8.933-023.0
LS3540G.3	9.802-603.0	8.725-358.0	8.725-359.0	9.802-609.0	8.933-023.0
LS4040G.3	9.802-603.0	8.725-358.0	8.725-359.0	9.802-609.0	8.933-023.0
LS5030G.3	9.802-603.0	8.725-358.0	8.725-359.0	9.802-609.0	8.933-023.0
LT4035	9.802-603.0	8.91-6488.0	8.916-322.0	9.802-606.0	9.802-607.0
LT4040	9.802-603.0	8.916-488.0	8.916-322.0	9.802-606.0	9.802-607.0
LT4540.2	8.753-824.0	8.753-821.0	8.753-822.0	8.752-835.0	8.753-823.0
LT5030	9.802-603.0	8.916-487.0	8.916-323.0	9.802-606.0	9.802-611.0
LT5030H	9.802-603.0	8.916-487.0	8.916-323.0	9.802-606.0	9.802-611.0
LT6035	9.802-603.0	8.916-488.0	8.916-322.0	9.802-606.0	9.802-607.0
LT6036.2	8.753-824.0	8.753-821.0	8.753-822.0	8.752-835.0	8.753-823.0
LX1025	9.802-608.0	8.725-364.0	8.725-365.0	9.802-606.0	9.802-614.0
LX1036.2	8.753-349.0	8.752-844.0	8.752-850.0	8.752-835.0	8.752-839.0
LX5050	9.802-604.0	9.802-615.0	9.802-616.0	9.802-606.0	9.802-629.0
LX5450	8.753-515.0	8.753-512.0	8.753-513.0	8.752-835.0	8.753-514.0
LX8030	9.802-608.0	8.725-364.0	8.725-365.0	9.802-606.0	9.802-614.0
LX9536.2	8.753-349.0	8.752-844.0	8.752-850.0	8.752-835.0	8.752-839.0

\*When replacing V-seals, use Packing with Brass

**Landa Pump Tool Kit**

A must for every service department. Save time using the right tool for the job. The Landa Pump Tool Kit can be purchased as a complete kit or individually.



9.802-954.0

Part #	Description
9.802-954.0	Landa Pump Tool Kit

**LANDA®**

Part #	Description of Individual Parts
9.802-581.0	Oil Seal Inserter Piston for LT Plunger Rod
9.802-564.0	Oil Seal Inserter Bushing for LT Plunger Rod
9.802-580.0	Oil Seal Inserter Piston for LM Plunger Rod
9.802-563.0	Oil Seal Inserter Bushing for LM Plunger Rod
9.802-571.0	Allen Wrench, 8mm for LT Manifold bolts
9.802-567.0	Allen Wrench, 6mm for LM Manifold bolts
9.802-570.0	Allen Wrench, 5mm for LM-LT Crankcase cover bolts
9.802-565.0	Oil Seal Inserter Bushing for LT Crankshaft
9.802-566.0	Oil Seal Inserter Bushing for LM Crankshaft
9.802-568.0	Piston Seal Extractor
9.802-572.0	U-Seal Inserter Piston for LT Manifold
9.802-578.0	U-Seal Inserter Bushing for LT Manifold
9.802-573.0	U-Seal Inserter Piston for LM Manifold
9.802-579.0	U-Seal Inserter Bushing for LM Manifold
9.802-569.0	Hammer, Plastic Head
9.802-574.0	Plastic Tool Box

**Landa Pump Oil**

**LANDA®**



Formulated to exceed the factory specifications for Landa, Admiral, AR, Interpump, General and other high-pressure pumps.

Part #	Description
8.923-424.0	32 oz Landa Pump Oil

**Landa Fuel Filter / Water Separator**

**LANDA®**



8.709-158.0

Removes water from fuel  
Replace elements without tools  
10 micron element  
1/4" FPT inlet and outlet  
Filters gasoline and diesel fuel

Part #	Description
8.709-158.0	Filter, Fuel/Water Separator
8.709-161.0	Replacement Element
8.709-163.0	Replacement Element, Fuel/Water Separator - Heavy-duty
8.709-164.0	Kit, O-Rings & Drain Plug
8.700-553.0	Kit, O-Rings, Drain Plug, Cup
8.700-554.0	Plug, Vent, Plastic
8.756-590.0	Normal Maintenance Kit
8.756-717.0	Oil Seal Maintenance Kit

**Discharge Manifold / Rupture Disk**

**LANDA®**



Prevents dangerous thermal expansion of water in the coil  
Ensures operator safety

Part #	Description
9.149-003.0	Coil Outlet Discharge Manifold
8.725-944.0	Rupture Disk, 8000 PSI, Red
9.151-014.0	Rupture Disk, 5000 PSI, Blue
9.184-030.0	Rupture Disk Spacer

**Adjustable Thermostat Switches LANDA®  
for Landa Discharge Manifold**



For use with Landa discharge manifold  
Capillary tube provides fast response time  
Prevents burner from overheating  
Two models adjustable to 240°F or 302°F

Part #	Description
8.750-094.0	150°C/302°F, 2 meter capillary
8.750-095.0	120°C/240°F, 2 meter capillary

**Landa Fuel Tanks**



International color coded for gas (red) and diesel (green)  
Rugged fill neck cap with vent  
Semi transparent shows fuel level  
Heavy-duty 14 gauge

Part #	Description
8.706-603.0	10 gal Poly, Yellow, Skids
8.706-604.0	5 gal Poly, Red, Skids
8.706-606.0	10 gal Poly, Red, SGHW
8.706-626.0	6 gal Poly, Yellow, VHW/MVP/MVC
8.706-627.0	6 gal Poly, Red, MPG

Note: Cap not included with tank

**Landa Fuel Caps**

**LANDA®**



9.802-089.0

9.802-082.0

8.706-629.0, 8.706-637.0

Part #	Description
9.802-089.0	Threaded Cap (Fits All Poly Fuel Tanks)
8.706-629.0	14" w/ Fuel Gauge, PHW & PGHW Metal Tanks
8.706-637.0	18" w/ Fuel Gauge, SGHW Metal Tanks
9.802-082.0	Plastic, Twist Lock, PHW Metal Tanks

**Float Tank**

**LANDA®**



3.5 gallon capacity  
22" x 13-1/2" x 5"  
Heavy 3/16" durable plastic  
Convenient mounting tabs  
Complete assemblies available, call with model number

Part #	Description
9.802-084.0	Universal Plastic Float Tank
8.912-233.0	Lid & Hinges

**Copper Fuel Dip Tubes**

**LANDA®**



Part #	Description
8.706-957.0	PHW Fuel, 12", Brass
8.902-250.0	HS Fuel, 6.5", Brass
8.902-251.0	VHW Fuel, 7.5", Brass
8.902-252.0	MHP Fuel, 17", Brass

**Adjustable Thermostat Switches LANDA®**



Capillary tube provides fast response time  
Prevents burner from overheating  
Adjustable to 300°F

Part #	Description
9.802-285.0	300°
8.712-186.0	175°, SJ Units

**Landa Coils**



8.925-216.0

**LANDA®**  
Cold-rolled pipe, no weak points from heating to make bends  
Heavy-duty schedule 80 carbon steel pipe  
"Aluminized steel" wrapper  
Best warranty in the industry

Part #	Description
8.925-216.0	DuraCoil 20" Dia, Sch 80, with Aluminized Steel Wrap, Horizontal
9.803-134.0	DuraCoil 14.5" Dia, Sch 80, MVC, VHP
8.914-962.0	DuraCoil 14.5" Dia, Sch 80, MHC, HOT
9.803-135.0	VNG-S after 4/99, new style, 18" dia., ENG,VNG, NG,VHG
8.912-247.0	DuraCoil, VNG, Large, after 3/97, new style ENG,VNG,NG
8.912-241.0	VNG-S, 16" (5/89-3/99) Except 8-2500, 6-3000, old style
8.912-240.0	VNG-S Except 8-2500, 6-3000, old style pre 5/89
8.912-248.0	DuraCoil, 6-3,8-3 VNG/VHG for modulating thermo
8.718-911.0	Coil Clean Chemical, 8#

**Landa Top & Bottom Wraps**



8.912-187.0



8.912-188.0

**LANDA®**  
Stainless and mild steel



8.912-866.0

Part #	Description
8.912-187.0	Top, Yellow
8.912-192.0	Top, Stainless Steel, PHW
8.914-969.0	Top, Stainless Steel, MHC, HOT
8.917-500.0	Top, Yellow, MHC, HOT
8.912-191.0	Bottom, Wrinkle Black, PHW
8.914-946.0	Bottom, Wrinkle Black, MHC, HOT
8.912-188.0	Bottom, Yellow
8.912-866.0	Outer, MVC
9.803-027.0	Outer, Stainless, MVC

**Coil Insulation**



9.802-883.0



9.802-894.0



8.717-396.0



9.802-900.0



9.802-901.0



9.802-902.0

**LANDA®**  
Refractory grade ceramic  
Retains heat inside coil for better fuel efficiency and paint protection

Part #	Description
9.802-883.0	Front Head, No Hole
8.735-002.0	Front Head, No Hole, 16"
9.802-894.0	Burner Head, with Hole
8.731-284.0	Burner Head, with Hole, 16"
8.933-009.0	Gasket, Burner Plate
8.717-424.0	Gasket, Skid Stackless Top
8.717-425.0	Gasket, Stackless Adapter

Part #	Description
9.802-900.0	Tank Bottom, 1" Blanket, VHW, VHP
9.802-901.0	Tank Head 16" OD x 8" ID, VHW, VHP
8.717-396.0	Disk, Flash Pan, GTO (2 req)
8.717-410.0	Blanket, w/ Foil sqft (10 sqft req)
9.802-896.0	Blanket-No Foil, 24" x 57", Horizontal
9.802-902.0	Blanket-Die Cut, 28" x 24", Horizontal
8.717-433.0	Blanket-Die Cut, 33" x 89" (VNG)
8.750-917.0	Blanket, 1/2" x 26" x 60"



**Landa Unloader Valves**

**LANDA®**



VBA35

PA

- PA VB8 - 8 GPM, 3650 max PSI
- VBXL - 13 GPM, 3000 max PSI
- VBA35 - 6.6 GPM, 3500 max PSI
- MV520 - 8 GPM, 2000 max PSI
- PA - 8 GPM, 3360 max PSI
- VB55 - 8 GPM, 3200 max PSI

Part #	Description
9.802-362.0	PA VB8 w/ switch (N/C) for PHW
9.803-899.0	VBA35 for Landa LG, LD and LE pumps
8.715-508.0	VBXL 13 GPM @ 3000 PSI with Knob
8.712-589.0	MV520 for Landa LD and LE pumps
9.803-900.0	VBA35 for Landa LM and LS pumps
9.802-363.0	PA for Landa LM and LS pumps
9.802-361.0	VB55 w/ 1/8" Bore for Easy Start
8.715-502.0	HM DX Unset (921462)

**Vinyl Skid Covers**

**LANDA®**

Custom-designed covers provide all-weather protection for Landa's skid-mounted pressure washers. Made of seamless, truck-tarp-quality, vinyl-coated polyester (18 oz. per square yard), the covers fit snugly over the equipment so there is no need to tie down the cover. The covers are both waterproof and capable of withstanding high winds.



8.709-109.0

Part #	Description
8.709-109.0	SDHW, SGHW, Vinyl Cover
8.749-946.0	PGHW, PGDC, Vinyl Cover
8.709-111.0	PGHW, PGDC (pre-2008 models only)

**Landa Flow Switch**

**LANDA®**



8.933-006.0

- Horizontal or vertical mount
- 4350 PSI
- 8 GPM max flow, 1.8 GPM min flow
- 180°F
- 12-250V, .8 amps
- 3/8" FPT inlet/outlet
- 2 wire reed

Part #	Description
8.933-006.0	Landa MV60, Versatile Mount
8.712-244.0	Vertical Mount Only
9.803-266.0	Replacement Reed Switch

**Flue Adapters**

**LANDA®**



8.717-745.0

8.717-733.0

Used to vent exhaust from horizontal hot water machines  
Hot dipped galvanized  
Adapts to standard stove pipe

Part #	Description
8.903-430.0	8" without Stack, new style kit
8.717-745.0	8" without Stack, new style
8.750-310.0	8" without Stack, HOT, MHC
8.717-769.0	10" without Stack, SLT/SLX
8.717-733.0	8" with Stack, old style
8.717-734.0	10" with Stack, old style
8.903-428.0	10" SLX Models
8.903-429.0	10" SLT Models

\*Includes insulation and mounting hardware

**Wayne Burners  
for Landa Pressure Washers**



Landa's Hot Water Oil Fired Machines are now being built exclusively with Wayne Burners. Wayne Combustion has been building quality burners since 1928. They are known in the marketplace for superior reliability and ultra-high efficiency. The Wayne Burners have the following features:

- Lower Emissions
- Improved Efficiencies
- Positive flame retention
- Controlled Flame Pattern
- Low Nozzle Temperatures
- High static pressure overcomes adverse draft conditions for a better air/oil mixture.

Part #	Description	Operating Voltage	Air Cone Size	Fuel Pump Voltage
8.756-091.0	Burner, MSR 3.75 120V 3T 120V S	120v	#5A	120v
8.756-177.0	Burner, EHASR 3.00 230V 1T 120V S	230v	#8A	120v
8.756-178.0	Burner, EHASR 3.00 120V 1T 120V S	120v	#8A	120v
8.756-335.0	Burner, EHASR 120V 2T 24V S	120v	#8A	24v
8.756-336.0	Burner, EHASR 230V 2T 24V S	230v	#8A	24v
8.756-383.0	Burner, EHASR 120VAC 2T 24V S	120v	#4A	24v
8.756-384.0	Burner, EHASR 230VAC 2T 24V S	230v	#4A	24v
8.756-412.0	Burner, MSR 13.5VDC 2T 12VDC S	13.5vDC	#4A8	12vDC
8.756-413.0	Burner, EHASR 120V 2T 120V S	120v	#4A	120v
8.756-435.0	Burner, EHASR 120V 2T 120V S	120v	#7A	120v
8.756-480.0	Burner, EHASR 12VDC D0 2T 12VDC S	12vDC	#4A	12vDC
8.756-644.0	Burner, MSR 120V 2T 24V S	120v	#8A	24v
8.756-923.0	Burner, EH 1.75 120V 2T 120V S	120v	3.56" ID Flamelock	120v

**Wayne Burner Chart**



Wayne Burner Part #	Description Motor / Coil	Fuel Pump	Ignitor	Burner Motor	Burner Fan	Coupling
8.756-091.0	Burner, MSR 3.75 120V 3T 120V S	8.756-290.0	8.700-803.0	8.756-292.0	8.700-726.0	8.700-822.0
8.756-177.0	Burner, EHASR 3.00 230V 1T 120V S	8.756-290.0	8.756-291.0	8.756-294.0	8.700-730.0	8.700-776.0
8.756-178.0	Burner, EHASR 3.00 120V 1T 120V S	8.756-290.0	8.700-802.0	8.756-293.0	8.700-730.0	8.700-776.0
8.756-335.0	Burner, EHASR 120V 2T 24V S	8.756-437.0	8.700-802.0	8.756-293.0	8.700-730.0	8.700-776.0
8.756-336.0	Burner, EHASR 230V 2T 24V S	8.756-437.0	8.756-291.0	8.756-294.0	8.700-730.0	8.700-776.0
8.756-383.0	Burner, EHASR 120VAC 2T 24V S	8.756-437.0	8.700-802.0	8.756-436.0	8.756-438.0	8.700-776.0
8.756-384.0	Burner, EHASR 230VAC 2T 24V S	8.756-437.0	8.756-291.0	8.700-745.0	8.756-438.0	8.700-776.0
8.756-412.0	Burner, MSR 13.5VDC 2T 12VDC S	8.756-437.0	9.107-507.0	8.700-739.0	8.756-660.0	8.700-721.0
8.756-413.0	Burner, EHASR 120V 2T 120V S	8.700-760.0	8.700-802.0	8.756-436.0	8.756-438.0	8.700-776.0
8.756-435.0	Burner, EHASR 120V 2T 120V S	8.756-290.0	8.700-802.0	8.756-293.0	8.700-730.0	8.700-776.0
8.756-480.0	Burner, EHASR 12VDC D0 2T 12VDC S	8.756-437.0	9.107-507.0	8.756-716.0	8.756-726.0	8.756-715.0
8.756-644.0	Burner, MSR 120V 2T 24V S	8.756-437.0	8.700-803.0	8.756-292.0	8.700-728.0	8.700-822.0
8.756-923.0	Burner, EH 1.75 120V 2T 120V S	8.717-814.0	8.700-802.0	8.756-436.0	8.756-438.0	8.700-776.0

**Landa Burner Chart (KNA Burner)**

Surefire Part #	Series	Description Motor / Coil	Motor	Ignitor Transformer	Fuel Pump	Solenoid Coil	Electrode Assembly	Blower Wheel
8.918-901.0		KNA-S 120V / 120V	8.750-517.0	8.918-449.0	8.753-300.0	8.750-763.0	8.750-778.0	8.750-052.0
8.918-903.0		KNA-S 230V / 120V	8.750-518.0	8.918-450.0	8.753-300.0	8.750-763.0	8.750-778.0	8.752-052.0
8.918-905.0		KNA-S 12V / 12V	8.751-074.0	8.918-451.0	8.753-300.0	8.750-764.0	8.751-342.0	8.751-072.0
8.918-907.0		KNA-S 120V / 120V	8.750-517.0	8.918-449.0	8.700-759.0	9.802-640.0	8.750-778.0	8.750-052.0
8.918-909.0		KNA-S 230V / 230V	8.750-518.0	8.918-450.0	8.750-760.0	9.802-641.0	8.750-778.0	8.750-052.0
8.919-911.0		KNA-S 12V / 12V	8.751-074.0	8.918-451.0	8.700-758.0	8.700-794.0	8.751-342.0	8.751-072.0
8.918-913.0	PGHW4-30224E PGHW4-40324E HS-3000	KNA-S 120V / 120V	8.750-517.0	8-918-449.0	8.700-759.0	9.802-640.0	8.750-778.0	8.750-052.0
8.918-915.0	HOT3-11024D HOT3-30036D	KNA-S 120V / 120V	8.750-517.0	8-918-449.0	8.700-759.0	9.802-640.0	8.750-778.0	8.750-052.0
8.918-917.0	PHW4-22024A PHW4-22024B PHW4-22024G PHW4-22024H PHW4-30024A PHW4-30024B PHW4-30024G PHW4-30024H	KNA-S 230V / 230V	8.750-518.0	8.918-450.0	8.700-758.0	8.700-794.0	8.750-778.0	8.750-052.0
8.918-919.0	MHC3-25124 MHC3-30324 MHC4-30324 MHC4-30324E MHC4-30324E/S MHC4-35324E PGDC4-35324E PGDC4-35324E PGDC4-35224E PGDC5-35324E MHP4-30324 MHP4-35224E MHP4-35324E	KNA-S 12V / 12V	8.751-074.0	8.918-451.0	8.700-758.0	8.700-794.0	8.751-342.0	8.751-072.0
8.920-547.0		KNA-S 230V / 230V	8.750-518.0	8.918-450.0	8.750-760.0	9.802-641.0	8.750-778.0	8.750-052.0
8.918-902.0		KNA-S 120V / 120V	8.750-517.0	8.918-449.0	8.753-300.0	8.750-763.0	8.750-778.0	8.750-052.0
8.918-904.0		KNA-S 230V / 230V	8.750-518.0	8.918-450.0	8.753-300.0	8.750-762.0	8.750-778.0	8.750-052.0
8.918-906.0		KNA-S 12V / 12V	8.751-074.0	8.918-451.0	8.753-300.0	8.750-764.0	8.751-342.0	8.751-072.0
8.918-908.0		KNA-S 12V / 12V	8.751-074.0	8.918-451.0	8.753-300.0	8.750-764.0	8.751-342.0	8.751-072.0
8.918-910.0		KNA-S 12V / 12V	8.751-074.0	8.918-451.0	8.750-758.0	8.700-794.0	8.751-342.0	8.751-072.0
8.918-912.0		KNA-S 230V / 12V	8.750-518.0	8.918-450.0	8.750-758.0	8.700-794.0	8.750-778.0	8.750-052.0
8.918-914.0	PHW3-11024D	KNA-S 120V / 12V	8.750-517.0	8.918-449.0	8.750-758.0	8.700-794.0	8.750-778.0	8.750-052.0
8.918-916.0	PHW4-22024C PHW4-22024F PHW4-30024C PHW4-30024F	KNA-S 120V / 12V	8.750-517.0	8.918-449.0	8.750-758.0	8.700-794.0	8.750-778.0	8.750-052.0
8.918-918.0	HOT4-20024A HOT4-20024G	KNA-S 230V / 120V	8.750-518.0	8.918-450.0	8.700-759.0	9.802-640.0	8.750-778.0	8.750-052.0
8.919-920.0	HOT2-11026D HOT2-15026D HOT2-11024D HOT2-15024D	KNA-S 120V / 120V	8.750-517.0	8.918-449.0	8.700-759.0	9.802-640.0	8.750-778.0	8.750-052.0
8.920-645.0	PGHW5-50524E ECOS-7000 PGHW5-35324E PGHW5-30224E PDHW5-35624E/G PDWH5-35624E/G/SS	KNA-M 120V / 120V	8.752-930.0	8.918-449.0	8.700-759.0	9.802-640.0	8.750-778.0	8.752-928.0
8.920-647.0	PHW5-30024B	KNA-M 230V / 12V	8.752-931.0	8.918-450.0	8.750-758.0	8.700-794.0	8.750-778.0	8.752-928.0
8.920-649.0		KNA-M 120V / 120V	8.752-930.0	8.918-449.0	8.700-759.0	9.802-640.0	8.750-778.0	8.752-928.0
8.920-651.0		KNA-L 230V / 120V	8.752-931.0	8.918-449.0	8.752-923.0	8.752-924.0	8.750-778.0	8.752-928.0
8.920-961.0		KNA-M 12V / 12V	8.752-933.0	8.918-451.0	8.750-758.0	8.700-794.0	8.751-342.0	8.752-929.0
8.920-646.0	PHW5-30024C	KNA-M 120V / 12V	8.752-930.0	8.918-449.0	8.750-758.0	8.700-794.0	8.750-778.0	8.752-928.0
8.920-648.0		KNA-M 230V / 12V	8.752-931.0	8.918-450.0	8.750-758.0	8.700-794.0	8.750-778.0	
8.920-650.0		KNA-L 120V / 120V	8.752-930.0	8.918-449.0	8.752-923.0	8.752-924.0	8.750-778.0	8.752-928.0
8.920-960.0	SLT6-32324E SLT8-30324E SLX10-25324E SLX6-32624E SLT8-32624E SLX10-32624E	KNA-L 120V / 120V	8.752-930.0	8.918-449.0	8.752-923.0	8.752-924.0	8.750-778.0	8.752-928.0
8.920-962.0		KNA-M 12V / 12V	8.752-933.0	8.918-451.0	8.750-758.0	8.700-794.0	8.751-342.0	8.752-929.0



# Innovation at Every Turn

Let us help you become more productive and profitable

Kärcher is the world market leader in cleaning products. For more power with less consumption and shorter cleaning times. Kärcher has the right equipment with truly innovative solutions that are often game-changers in the industry. Our goal is to help you Get Dialed In no matter what your needs.

### LEGACY "BEST" SPRAY GUN



Ergonomically designed to be the most comfortable gun on the market.



- PSI: 5000
- GPM: 12
- Temperature: 300°F
- 3/8" FPT inlet x 1/4" FPT outlet
- Weight: 21 oz
- Ideal for commercial cleaning and long work time applications

PART NO.	DESCRIPTION
8.751-213.0	"Best" Spray Gun
8.701-673.0	Unitized Valve Kit

### LEGACY "INDUSTRIAL" SPRAY GUN



Featuring a comfortable grip to reduce user fatigue.



- PSI: 5000
- GPM: 10.4
- Temperature: 300°F
- 3/8" FPT inlet x 1/4" FPT outlet
- Weight: 19.84 oz
- Ideal for various industrial cleaning applications

PART NO.	DESCRIPTION
8.751-214.0	"Industrial" Spray Gun
8.751-119.0	Valve Kit

### PA LINEAR GUN

Ergonomic design minimizes fatigue for operator.



- PSI: 4500
- GPM: 10.5
- Temperature: 320°F
- 3/8" FPT inlet x 1/4" FPT outlet
- Weight: 19.2 oz

PART NO.	DESCRIPTION
8.752-080.0	PA Linear Gun
9.801-398.0	PA Linear Gun Repair Kit

### AP TRIGGER GUN



- PSI: 4500
- GPM: 8
- Temperature: 320°F
- 3/8" FPT inlet x 1/4" FPT outlet
- Weight: 16.08 oz

PART NO.	OLD NO.	DESCRIPTION
8.754-907.0	353030	MV925

### M407 TRIGGER GUN



- PSI: 4000
- GPM: 7
- Temperature: 250°F
- 3/8" FPT inlet x 1/4" FPT outlet
- Weight: 13.4 oz

PART NO.	DESCRIPTION
8.750-247.0	M407 Trigger Gun
8.750-456.0	M407 Gun Repair Kit

### J.E. ADAMS GUN



- PSI: 4500
- GPM: 12
- Temperature: 300°F
- 3/8" FPT inlet x 1/4" FPT outlet

PART NO.	DESCRIPTION
8.710-391.0	J.A. Trigger Gun

### GIANT TRIGGER GUNS



The original "heavy-weight".



- PSI: 5000
- GPM: 10
- Temperature: 300°F
- 3/8" FPT inlet x 1/4" FPT outlet
- Weight: 29.28 oz

PART NO.	OLD NO.	DESCRIPTION
8.710-394.0	352290	21290C - Brass Outlet
8.710-392.0	352250	21250B - Stainless-Steel Outlet
8.722-172.0	G021227	Repair Kit



**SUTTNER TRIGGER GUNS**



- PSI: 1800
- GPM: 21
- Temperature: 300°F
- 3/8" FPT inlet x 1/4" FPT outlet
- Weight: 1.30 lb

**ST-2620**

PART NO.	OLD NO.	DESCRIPTION
8.723-666.0	87236660	ST-2620
8.723-667.0	87236670	ST-2720 Stainless-Steel

Excellent for truck and fleet washing applications.



- PSI: 2000
- GPM: 8
- Temperature: 320°F
- 3/8" FPT inlet x 1/4" FPT outlet
- Weight: .82 lb

**ST-10 POM**

PART NO.	OLD NO.	DESCRIPTION
8.710-372.0	352210P	ST-810 Gun



- PSI: 5000
- GPM: 12
- Temperature: 300°F
- 3/8" FPT inlet x 1/4" FPT outlet
- Weight: 21 oz

**ST-2605**

PART NO.	OLD NO.	DESCRIPTION
8.710-376.0	352219	ST-2605
8.701-673.0	089850	Unitized Valve

Extreme durability with easy pull trigger.



- PSI: 5000
- GPM: 12
- Temperature: 300°F
- 3/8" FPT inlet x 1/4" FPT outlet
- Weight: 21 oz

**ST-2305**

PART NO.	OLD NO.	DESCRIPTION
8.710-386.0	352238	ST-2305
8.701-673.0	089850	Unitized Valve
8.701-674.0	089851	Unitized Weep Valve

Extreme durability with easy pull trigger.



- PSI: 5000
- GPM: 12
- Temperature: 300°F
- 3/8" FPT inlet x 1/4" FPT outlet
- Weight: 20.8 oz
- Ceramic ball in valve for higher chemical resistance
- Easy pull trigger

**ST-2315**

PART NO.	DESCRIPTION
9.106-073.0	ST-2315, Ceramic Ball Valve for Chemical and Acid Resistance

**SUTTNER TRIGGER GUNS**



15° offset angle thru gun for easier overhead use. The handle style for "Big Hands".



- PSI: 5000
- GPM: 12
- Temperature: 300°F
- 3/8" FPT inlet x 1/4" FPT outlet
- Weight: 26 oz

**ST-2000**

PART NO.	OLD NO.	DESCRIPTION
8.710-388.0	352240	ST-2000
8.701-663.0	089614	Unitized Valve - 4000 PSI
8.751-119.0		Unitized Valve - 5000 PSI
8.701-665.0	089631	Unitized Weep Valve

The perennial favorite for general pressure washer applications.



- PSI: 5000
- GPM: 10.4
- Temperature: 300°F
- 3/8" FPT inlet x 1/4" FPT outlet
- Weight: 20.5 oz

**ST-1500**

PART NO.	OLD NO.	DESCRIPTION
8.710-384.0	352235	ST-1500
8.710-385.0	352236	ST-1500 w/ Weep
8.701-663.0	089614	Unitized Valve - 4000 PSI
8.751-119.0		Unitized Valve - 5000 PSI
8.701-665.0	089631	Unitized Weep Valve

Relax action design, stainless-steel gun.



- PSI: 5000
- GPM: 12
- Temperature: 300°F
- 3/8" FPT inlet x 1/4" FPT outlet
- Weight: 21 oz

**ST-2700**

PART NO.	OLD NO.	DESCRIPTION
8.710-389.0	352243	ST-2700
8.701-658.0	089070	Unitized Valve

**CERAMIC UNITIZED BALL VALVE**



- Ceramic ball
- Highly resistant against nearly all soaps and acids
- Fits in ST-2300, 2305, 2605, 2700 spray guns as a repair kit

PART NO.	DESCRIPTION
8.749-907.0	Ceramic Unitized Ball Valve

### PA TRIGGER GUN



- PSI: 3200
- GPM: 8
- Temperature: 320°F
- 3/8" FPT inlet x 1/4" FPT outlet
- Weight: 10 oz

PART NO.	OLD NO.	DESCRIPTION
8.710-440.0	353207	RL20
8.704-180.0	109993	Repair Kit



- PSI: 5000
- GPM: 10.5
- Temperature: 300°F
- 3/8" FPT inlet x 1/4" FPT outlet
- Weight: 26 oz

PART NO.	OLD NO.	DESCRIPTION
8.710-377.0	352221	RL30-YG5000
8.704-616.0	111976	Repair Kit



- PSI: 5000
- GPM: 10.5
- Temperature: 300°F
- 3/8" FPT inlet x 1/4" FPT outlet
- Weight: 27.5 oz

Vega 5000

PART NO.	OLD NO.	DESCRIPTION
8.710-378.0	352222-5	Vega 5000
8.704-232.0	110550	Valve Kit Vega
8.704-615.0	111950	Repair Kit

Easy pull and easy to hold with matching blue lance.



- PSI: 5650
- GPM: 8
- Temperature: 320°F
- 3/8" FPT inlet x 1/4" FPT outlet
- Weight: 23.3 oz
- Blue vent grip, stainless-steel lance has 1/4" BSP threads

RL-56 Gun

40" Stainless-Steel Blue Grip Lance



PART NO.	OLD NO.	DESCRIPTION
9.802-227.0		RL-56 Blue Gun and Wand (does not come with nozzle protector)
8.710-446.0	353250	RL-56 Blue Gun
8.710-645.0	368440PB	40" Stainless-Steel Lance w/blue vent grip (comes with nozzle protector)
8.704-610.0	111814	Repair Kit - RL-55

### SUTTNER TRIGGER GUN



15° offset angle thru gun for easier overhead use.



- PSI: 4000
- GPM: 12
- Temperature: 300°F
- 3/8" FPT inlet x 1/4" FPT outlet
- Weight: 23 oz

OLD NO.	OLD NO.	DESCRIPTION
8.710-370.0	352201	ST-601
8.701-663.0	089614	Unitized Valve - 4000 PSI
8.751-119.0		Unitized Valve - 5000 PSI

### BIG GUNS



- PSI: 3200
- GPM: 53
- Temperature: 320°F
- 3/4" FPT inlet x 1/2" FPT outlet
- Weight: 47.5 oz

Model RL204



- PSI: 7250
- GPM: 21
- Temperature: 210°F
- 1/2" Stainless-Steel FPT inlet / outlet
- Weight: 60.3 oz

Model RL84 "Big Black Gun"

PART NO.	OLD NO.	DESCRIPTION
8.740-165.0		Model RL204
8.749-327.0		Repair Kit - Model RL204
8.704-136.0	109775	Repair Kit - Model 100
8.704-612.0	111900	Repair Kit - Model 160
8.710-445.0	353246	Model RL84
8.750-459.0		Repair Kit - RL84

### ML320



Excellent light-duty gun.



- PSI: 2320
- GPM: 6.6
- Temperature: 212°F
- 1/4" M inlet x 1/4" F outlet
- Weight: 8.82 oz

ML320

PART NO.	DESCRIPTION
8.757-839.0	ML320

## AP1000 OPEN GUN

Durable glass reinforced handle.



- PSI: 4000
- GPM: 12
- Temperature: 300°F
- 3/8" FPT inlet x 1/4" FPT outlet
- Weight: 16.7 oz
- Tubular flow-thru intervals for high pressure and efficiency

AP-1000 Open Gun

PART NO.	OLD NO.	DESCRIPTION
8.710-396.0	352600	Legacy AP1000 Open Gun

## OPEN GUNS

Just plain comfortable!



- PSI: 4060
- GPM: 8
- Temperature: 300°F
- 3/8" FPT inlet x 1/4" FPT outlet
- Weight: 12.3 oz

MV925 Open Gun

PART NO.	DESCRIPTION
8.754-988.0	MV925 without trigger

## ST-1500H OPEN GUN



- PSI: 5000
- GPM: 10.4
- Temperature: 300°F
- 3/8" FPT inlet x 1/4" FPT outlet
- Weight: 20.5 oz
- Flow through design for less down time

ST-1500

PART NO.	DESCRIPTION
8.710-383.0	ST-1500 Open Gun

## FLOW-THRU GUN



- Pistol-grip gun handle
- Tough polyurethane insulation
- Cushion grip
- Full grip or slim line handle

"Full" Grip

PART NO.	OLD NO.	DESCRIPTION
8.710-400.0	352606	Full Black Grip 3/8" FPT x 1/4" FPT Gun Handle with 18" Lance
8.710-403.0	352614	Slim Red Grip 1/4" M x 1/4" F
8.710-404.0	52616	Full Red Grip 3/8" F x 1/4" M

## AP DUMP GUNS

Water continues to run through the tube even when trigger gun is closed.



- PSI: 3000
- GPM: 10.5
- Temperature: 140°F
- 3/8" FPT inlet x 1/8" FPT outlet

AP Single Barrel Dump Gun

PART NO.	OLD NO.	DESCRIPTION
8.710-405.0	352810	Dump Gun 16" Lance
8.710-406.0	352812	Dump Gun 40" Lance
8.704-169.0	109905	Repair Kit

## DUMP GUN

Industrial duty dual-barrel.



- PSI: 3000
- GPM: 10
- Temperature: 200°F
- 3/8" FPT inlet x 1/4" FPT outlet

Dual Barrel Dump Gun

PART NO.	OLD NO.	DESCRIPTION
8.710-408.0	352820	Dump Gun w/ 36" Barrel
8.700-311.0	075296	Repair Kits

## LEGACY SUPERLITE STAINLESS-STEEL DUAL LANCE



Superlite stainless-steel with nozzle guard.



- PSI: 4000
- Temperature: 200°F
- Side handle / valve actuator
- Viton seal
- Forged brass valve body
- 1/4" MPT inlet
- 1/8" Stainless-steel outlet tubing

Dual Lance with Nozzle Guard

PART NO.	OLD NO.	DESCRIPTION
8.710-618.0	368160	6" - 37.8 oz
8.710-620.0	368165	72" - 56.0 oz
8.900-781.0	109490	Seal Kit

### LEGACY SQUARE MOLDED GRIP LANCES



- PSI: 5250
- GPM: 12
- Temperature: 300°F
- High-quality chrome-plate finish
- Solid molded polymer construction handle with hollow-rib for increased heat dissipation
- 1/4" male inlet and outlet

PART NO.	DESCRIPTION
8.752-898.0	Lance, Molded, 12"
8.752-899.0	Lance, Molded, 20"
8.752-900.0	Lance, Molded, 24"
8.752-901.0	Lance, Molded, 28"
8.752-902.0	Lance, Molded, 36"
8.752-903.0	Lance, Molded, 48"
8.752-904.0	Lance, Molded, 60"
8.752-905.0	Lance, Molded, 79"

### LEGACY OVAL MOLDED GRIP LANCES



Featuring a comfortable grip to reduce user fatigue.



- PSI: 5250
- Temperature: 300°F
- 1/4" male inlet and outlet
- Stainless-steel or high-quality chrome-plated finish
- Solid molded polymer construction handle with hollow rib grip for increased heat dissipation
- 4:1 safety factor

PART NO.	DESCRIPTION
Stainless-steel	
8.752-882.0	Lance, Molded, 12"
8.752-883.0	Lance, Molded, 20"
8.752-884.0	Lance, Molded, 24"
8.752-885.0	Lance, Molded, 28"
8.752-886.0	Lance, Molded, 36"
8.752-887.0	Lance, Molded, 48"
8.752-888.0	Lance, Molded, 60"
8.752-889.0	Lance, Molded, 79"
Chrome-plated	
8.752-890.0	Lance, Molded, 12"
8.752-891.0	Lance, Molded, 20"
8.752-892.0	Lance, Molded, 24"
8.752-893.0	Lance, Molded, 28"
8.752-894.0	Lance, Molded, 36"
8.752-906.0	Lance, Molded, 36", with handle
8.752-895.0	Lance, Molded, 48"
8.752-907.0	Lance, Molded, 48", with handle
8.752-896.0	Lance, Molded, 60"
8.752-897.0	Lance, Molded, 79"

### DUAL LANCES



Interpump Dual Lance.



- PSI: 3000
- GPM: 10
- Temperature: 220°F
- Excellent for downstream injector
- Zinc-plated for chemical resistance
- Brass and stainless-steel valve with Viton seals
- Side handle valve adjustment
- Non-deluxe outlet 1/4" FPT

PART NO.	OLD NO.	DESCRIPTION
8.710-612.0	368150	36" Standard
8.710-621.0	368172	72" Extended
8.904-277.0	368151X	36" Deluxe Standard
8.904-281.0	368173X	72" Deluxe Extended
8.900-135.0	084072X	Valve Repair Kit

### DUAL LANCES



Premium lance with stainless-steel inserted seat.

#### AL Premium Dual Lance



- PSI: 3600
- GPM: 10.5
- Temperature: 302°F
- 1/4" Tubing
- Vented grip
- 1/4" male inlet-female outlet

#### AL Basic Dual Lance



- PSI: 3600
- GPM: 10.5
- Temperature: 302°F
- 1/4" Tubing
- 1/8" Zinc-plated tubes
- Square-molded grip inlet

PART NO.	OLD NO.	DESCRIPTION
8.710-722.0	368925	Stainless-steel Pipe 1/8" Nozzles
9.803-267.0	AL8355VPKIT	Repair Kit
8.710-724.0	368927	Basic Dual Lance 1/4" Nozzles
8.720-548.0	AL004650300	Repair Kit
8.904-360.0*	368926X	AL Premium Deluxe w/ Quick Coupler and Soap Nozzle



\*Includes hardened-steel QC inlet plug, 1/8" 40 x 65° soap nozzle and top-quality quick coupler. See lances with deluxe noted above.

## SUTTNER DUAL LANCES



ST-54 with Side Handle

ST-53 with Knob

- GPM: 10
- Temperature: 300°F
- Zinc / Chromate Finish
- 38" Total Length
- Molded Grip
- High-Pressure, Thin-Wall Tubing
- Weight: 42 oz

PART NO.	OLD NO.	DESCRIPTION
8.710-613.0	368153	ST-53 w/ Knob (4000 PSI)
8.710-614.0	368154	ST-54 w/ Side Handle (4500 PSI)
8.701-594.0	086884	Repair Kit (ST-53)
8.900-153.0	086883X	Clamp Kit (ST-53/54)
8.701-602.0	086907	Repair Kit (ST-54)

## DUAL TRIGGER LANCE

Unique Design - Go from high - to low-pressure (rinse-to-soap) with a pull of the trigger. Use with separate trigger gun or as an open gun, and still change from high to low.



- PSI: 3600
- GPM: 12
- Temperature: 300°F
- Zinc-Plated Steel Tubes
- Stainless-Steel Seat
- Includes Nozzle Protector
- Weight: 39 oz

PART NO.	OLD NO.	DESCRIPTION
8.710-617.0	368158	48" Dual Trigger Lance
8.900-781.0	109490	Seal Kit

## LEGACY VENTED LANCES



- PSI: 5250
- Temperature: 300°F
- Handle made from molded glass-filled polyamide for heat dissipation with hollow insulators for increased heat venting
- Nozzle Protector Included
- 1/4" Male Inlet, 1/4" Female Outlet
- 4:1 Safety Factor
- Stainless-Steel or High-Quality Chrome-Plate Finish

PART NO.	DESCRIPTION
Stainless-steel	
8.752-868.0	Lance, Vented, 20"
8.752-869.0	Lance, Vented, 24"
8.752-871.0	Lance, Vented, 36"
8.752-872.0	Lance, Vented, 48"
8.752-873.0	Lance, Vented, 60"
8.752-874.0	Lance, Vented, 79"
Chrome-plated	
8.752-875.0	Lance, Vented, 20"
8.752-876.0	Lance, Vented, 24"
8.752-878.0	Lance, Vented, 36"
8.752-879.0	Lance, Vented, 48"
8.752-880.0	Lance, Vented, 60"
8.752-881.0	Lance, Vented, 79"

## AP UNISULATED LANCES



Stainless-steel or corrosion-resistant, bright zinc-plated lances made with 1/4" tubing.



- PSI: 4100
- Temperature: 300°F
- Superior Strength Rolled Threads
- 1/4" High-Pressure, Lightweight, Thin-Wall Tubing

PART NO.	OLD NO.	DESCRIPTION
Stainless-steel		
8.710-623.0	368212	Length, 12"
8.710-624.0	368220	Length, 20"
8.710-625.0	368224	Length, 24"
8.710-626.0	368228	Length, 28"
8.710-627.0	368236	Length, 36"
8.710-628.0	368248	Length, 48"
8.710-629.0	368260	Length, 60"
8.710-630.0	368278	Length, 78"
Zinc-plated		
8.710-631.0	368312	Length, 12"
8.710-632.0	368320	Length, 20"
8.710-633.0	368324	Length, 24"
8.710-634.0	368336	Length, 36"
8.710-635.0	368348	Length, 48"
8.710-636.0	368360	Length, 60"
8.710-637.0	368378	Length, 78"

NOTE: For 15° bend at lance discharge, place "BND" at end of the old part number

## SUTTNER PUSH AND PULL LANCE



Vented grip can be pushed and pulled up to 90°. For hard to reach applications, such as gutters, fenders, trucks and heavy equipment.



- PSI: 3050
- Temperature: 300°F
- 34" Stainless-Steel Lance

PART NO.	OLD NO.	DESCRIPTION
8.710-711.0	368880	ST-85 Push and Pull Lance

## BIG STAINLESS-STEEL LANCES AND SIDE HANDLES

For big guns!



- PSI: 4050
- Temperature: 300°F
- High-Pressure Stainless-Steel Pipe
- Complete With Adjustable Handle and Coupler for 1/4" MPT Nozzle
- 1/2" MPT Gun Connection
- Schedule 40 Pipe

PART NO.	OLD NO.	DESCRIPTION
8.904-081.0	352902A	20" Wand w/ Handle
8.904-083.0	352904A	40" Wand w/ Handle
8.904-086.0	352906A	Side Handle Only
8.710-411.0		39", Stainless-steel, 8700 PSI, 300°F, Inlet 1/2" MNPT, Outlet 1/4" MNPT



### LANCE HANDLES / ACCESSORIES

Vented grip, side handle with nut, and vented grip with side handle, can be user-attached to uninsulated lances or 1/4" steel pipe. Detachable and reusable!



PART NO.	OLD NO.	DESCRIPTION
8.710-717.0	368909P	Vent Grip Only (14" long)
8.904-357.0	368909PS	Grip w/ Side Handle
8.904-358.0	368920P	Side Handle w/ Nut



PART NO.	OLD NO.	DESCRIPTION
8.710-716.0	368909	Vent Grip Only (14" Long) ST-9
8.710-719.0	368911	Grip w/ Side Handle
8.710-720.0	368920	Side Handle w/ Nut

### MV LANCE HANDLE



- Use On All 1/4" Lances
- Easily Positioned Without Removal Of Nozzle

PART NO.	OLD NO.	DESCRIPTION
8.704-162.0	109873	1/4" Lance Handle

### X-JET LONG RANGE NOZZLE



- Projects Water and Chemical Up To 40'
- Chemicals Bypass Pump, Lance, Hose and Gun For Damage Protection
- Includes 15' Hose with In-Line Shut-Off Valve and Color-Coded Proportioners

PART NO.	OLD NO.	DESCRIPTION
8.710-474.0*	360103	X-Jet Long Range Nozzle, 2000-3000 PSI
8.710-475.0*	360104	X-Jet Long Range Nozzle, 3000-4000 PSI
8.710-473.0	360102	M5 X-Jet Variable Fan, 2000-3000 PSI, Long Range Nozzle

\*Includes Close Range Nozzle

### GUTTER CLEANER ATTACHMENT

Easily quick connect to any lance or extension wand to clean gutters or hard to reach areas. Angle improves reach and expands cleaning capabilities.



- PSI: 3500
- Temperature: 200° F
- Zinc-Plated
- Inlet 1/4" M Plug
- Inlet 1/4" F Plug

PART NO.	DESCRIPTION
8.711-324.0	1/4" Nipple x 1/4" QC

### ADJUSTABLE NOZZLE HOLDER

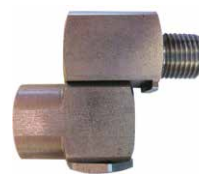

- PSI: 5700
- GPM: 10
- Temperature: 300° F
- Perfect For Cleaning Hard-To-Reach Areas Like Inside Containers or Gutters
- Nozzle Position Locks With Pressure
- Stainless-Steel
- 1/4" Female Inlet

PART NO.	DESCRIPTION
8.749-905.0	Outlet 1/4" FNPT
8.749-906.0	Outlet 1/4" Male

### ADJUSTABLE NOZZLE HOLDER



- Effortlessly Raise and Lower the Wand Using the Water Pressure
- Adjustable Pressure
- No Kick-Back or Whipping Action
- Easy-Grip Handle
- Easy to Install and Control
- Right or Left Hand Adjustable
- Durable, Reliable and Lightweight
- Reduce Fatigue and Time on the Job

PART NO.	DESCRIPTION
8.749-848.0	Extension Wand Control Kit

### SPRAY-FLEX™ FLEX WAND

Gives easy access to difficult spots, great for cleaning engines, roofs, eaves, or underneath almost anything! Holds its shape under pressure.



- PSI: 3000 and 5000
- Temperature: 190° F
- 90° Flexibility

PART NO.	OLD NO.	DESCRIPTION
8.710-597.0	368117	3000 PSI
8.710-596.0	368116	5000 PSI

**FIBERGLASS TELESCOPING WANDS**

High-quality telescoping wand reaches up to 24'; comes in three sizes to choose from, and is lightweight and balanced under pressure.



**Belt and Pole Clamp**

- PSI: 4000
- GPM: 10.5
- Temperature: 195° F
- 6' - 12' Wand Shown

PART NO.	OLD NO.	DESCRIPTION
8.710-589.0	368090	6'-12'
8.710-590.0	368091	6'-18'
8.710-591.0	368092	6'-24'
8.700-059.0	056008	Strap and Belt Shoulder Harness
8.711-324.0		Gutter Cleaning Attachment

PART NO.	OLD NO.	DESCRIPTION
8.723-896.0		TS12 Replacement Gun
8.710-595.0	368098	TS18 Replacement Gun
8.739-434.0	368099	TS24 Replacement Gun

**HOBBY GUN, LANCE AND HOSE**

Don't turn away hobby-unit owners. Complete replacement hose, gun and lance.



PART NO.	OLD NO.	DESCRIPTION
8.754-769.0	4-011137	Insulated Lance w/ Gun
9.112-526.0	4-011106	Lance w/ Coupler (Not Shown)
8.753-272.0	4-011105	Lance w/ #3 Hi/Low Varifan Nozzle
8.753-423.0	4-02010025M	1/4" x 25' Thermoplastic t, 22mm both ends

NOTE: See page 13 for more Hobby Hose

**LEGACY INDUSTRIAL GUN & LANCE**

Gun and Lance Combo



- PSI: 3500
- GPM: 10.4
- Temperature: 300° F
- Zinc-Plated Steel Tubes
- Stainless-Steel Seat
- Includes Nozzle Protector
- 36" Square-Molded Grip Lance with 1/4" Quick Coupled Socket
- Weight: 39 oz

PART NO.	DESCRIPTION
8.904-095.0	Legacy Gun and Lance w/ 3/8" MPT QC Inlet

**MV925 GUN AND LANCE COMBO**

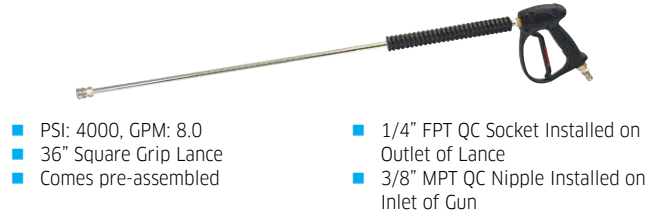

- PSI: 4000, GPM: 8.0
- 36" Square Grip Lance
- Comes pre-assembled
- 1/4" FPT QC Socket Installed on Outlet of Lance
- 3/8" MPT QC Nipple Installed on Inlet of Gun

PART NO.	DESCRIPTION
8.928-442.0	MV925 Gun

**MV925 GUN, LANCE AND HOSE COMBO**



- PSI: 4000
- GPM: 8
- 36" Square Grip Lance
- 3/8" MPT QC Nipple Installed on Inlet of Gun
- 1/4" FPT QC Socket Installed on Outlet of Lance
- R1 4000 PSI
- 3/8" x 50' Black Hose
- -38" FPT QC Sockets Installed on Hose

PART NO.	DESCRIPTION
8.928-443.0	MV925 Gun

**FLEX LANCES**

Flexes a full 180° and returns, saving broken wand repairs.



- PSI: 2500
- Temperature: 200° F
- Prevents bent lances and broken hose
- For Self-Serve Car Wash Bays
- Industrial-Grade Polyurethane Flex Section
- 1/4" Galvanized Pipe End Sections

PART NO.	OLD NO.	DESCRIPTION
8.710-598.0	368118	18", 1/4" MPT x 1/4" MPT
8.710-603.0	368121	21", 1/4" MPT x 1/8" FPT
8.710-604.0	368124	24", 1/4" MPT x 1/8" FPT

**PRESSURE WASHER ACCESSORY KIT**

**Kit 1 Includes:**

- Teflon Tape
- Hose, PSI: 4000, 3/8" x 50', R1, SoxSW
- Coupler, 3/8" Female Brass
- Wand, 18" M22 x 1/4" QC
- Gun, S2 3/8" Inlet, Lance with M22 Coupler

**Kit 2 Includes:**

- Teflon Tape
- Hose, PSI: 6000, 3/8" x 50', R2, SoxSW
- QC Nozzle, Stainless-Steel, 1/4", #4,.0 x 15
- Coupler, 3/8" Female Brass
- Wand, 18" M22 x 1/4" QC
- Gun, S2 3/8" Inlet, Lance with M22 Coupler



PART NO.	DESCRIPTION
8.903-454.0	Pressure Washer Accessory Kit 1
8.903-455.0	Pressure Washer Accessory Kit 2

## HOSE - LEGACY HIGH-PRESSURE

For use with hot or cold-water pressure washers.

Introducing the new Legacy hose. The Legacy hose is built to exceed the EN1829-2 Standard and will provide superior abrasion resistance that will increase the life of the hose. The Legacy hose is rated up to 250° F and is available in 4000 and 6000 PSI.

Both single- and double-wire braid hoses come with durable 8" bend restrictors on both ends.

The Legacy hose has a "bite-the-wire" coupling that grips the hose better than any other design.



- Temperature Rating: Legacy hoses are rated for continuous temperatures up to 250° F
- Easily Identified: Permanently embossed identification makes for easy tracing and owner protection.



- Unique Coupling: A "bite-the-wire" coupling actually reaches the wire braid for never-slip retention, far superior to the "compression" fittings used on conventional hoses.

## HOSE - 1-WIRE



- Black Bend Restrictor
- Rated to 250° F
- Smooth impression, oil resistant tube and black hose guard at both ends

## HOSE - 2-WIRE



- Red Bend Restrictor
- Rated to 250° F
- Smooth impression, oil resistant tube and red hose guard at both ends

PART NO.	SIZE	TEMPERATURE	PSI
3/8" MPT Swivel x 3/8" MPT Solid, 3/8" ID			
8.925-176.0	3/8" x 15'	250° F	4000
8.925-150.0	3/8" x 25'	250° F	4000
8.925-156.0	3/8" x 50'	250° F	4000
8.925-161.0	3/8" x 75'	250° F	4000
8.925-165.0	3/8" x 100'	250° F	4000
8.925-170.0	3/8" x 150'	250° F	4000
8.925-350.0	3/8" x 200'	250° F	4000
8.925-378.0	Case of 75 (8.925-156.0) 3/8" x 50' Hoses		
8.925-449.0	Case of 40 (8.925-165.0) 3/8" x 100' Hoses		
3/8" MPT Swivel x 3/8" MPT Swivel, 3/8" ID			
8.925-364.0	3/8" x 50'	250° F	4000
8.925-365.0	3/8" x 75'	250° F	4000
8.925-167.0	3/8" x 100'	250° F	4000
8.925-367.0	3/8" x 150'	250° F	4000
8.925-368.0	3/8" x 200'	250° F	4000
1/2" MPT Swivel x 1/2" MPT Solid			
8.925-236.0	1/2" x 50'	250° F	3000
8.925-237.0	1/2" x 75'	250° F	3000
8.925-238.0	1/2" x 100'	250° F	3000
1/4" MPT Swivel x 1/4" MPT, Solid, 1/4" ID			
8.925-143.0	1/4" x 25'	250° F	3000
8.925-144.0	1/4" x 30'	250° F	3000
8.925-145.0	1/4" x 50'	250° F	3000
8.925-146.0	1/4" x 75'	250° F	3000
8.925-147.0	1/4" x 100'	250° F	3000

PART NO.	SIZE	TEMPERATURE	PSI
3/8" MPT Swivel x 3/8" MPT Solid, 3/8" ID			
8.928-542.0	3/8" x 15'	250° F	6000
8.925-180.0	3/8" x 25'	250° F	6000
8.925-184.0	3/8" x 50'	250° F	6000
8.925-225.0	3/8" x 75'	250° F	6000
8.925-229.0	3/8" x 100'	250° F	6000
8.925-232.0	3/8" x 150'	250° F	6000
8.925-369.0	3/8" x 200'	250° F	6000
8.925-382.0	Case of 75 (8.925-184.0) 3/8" x 50' Hoses		
8.925-450.0	Case of 40 (8.925-229.0) 3/8" x 100' Hoses		
3/8" MPT Swivel x 3/8" MPT Swivel, 3/8" ID			
8.925-311.0	3/8" x 25'	250° F	6000
8.925-313.0	3/8" x 50'	250° F	6000
8.925-314.0	3/8" x 75'	250° F	6000
8.925-316.0	3/8" x 100'	250° F	6000
8.925-325.0	3/8" x 200'	250° F	6000
1/2" MPT Swivel x 1/2" MPT Solid, 1/2" ID			
8.925-247.0	1/2" x 50'	250° F	5000
8.925-249.0	1/2" x 75'	250° F	5000
8.925-253.0	1/2" x 100'	250° F	5000

**HOSE - RAWHIDE 1-WIRE**



- PSI: 3000
- Temperature: 250°F
- Smooth Non-Marking
- SO / SW Couplers Included

PART NO.	OLD NO.	LENGTH	TEMPERATURE	WORKING PSI	APPROX WT (LBS)
3/8" Smooth Yellow Hose					
8.901-800.0	158980	50' x 3/8" ID	250° F	3000	12.0
8.901-802.0	158985	75' x 3/8" ID	250° F	3000	17.0
8.901-804.0	158990	100' x 3/8" ID	250° F	3000	23.0
8.705-720.0*	158900	Must be purchased in 500 ft reels			
3/8" Smooth Blue Hose					
8.739-148.0	158780	50' x 3/8" ID	250° F	3000	12.0
8.739-149.0	158785	75' x 3/8" ID	250° F	3000	17.0
8.739-150.0	158790	100' x 3/8" ID	250° F	3000	23.0
8.739-369.0	158795	150' x 3/8" ID	250° F	3000	34.0
8.724-371.0	158700	Must be purchased in 500 ft reels			
3/8" Smooth Gray Hose					
8.749-935.0		50' x 3/8" ID	250° F	3000	13.0
8.749-936.0		100' x 3/8" ID	250° F	3000	25.0
8.749-945.0		Must be purchased in 500 ft reels			
1/4" Smooth Blue Hose					
8.901-796.0	158880	50' x 1/4" ID	250° F	3000	8.0
8.901-798.0	158890	100' x 1/4" ID	250° F	3000	16.0
8.705-718.0*	158800	Must be purchased in 500 ft reels			

\*500 ft reel, 50 ft incremental lengths (max three pieces)

**HOSE - LEGACY RAWHIDE 2-WIRE**



- PSI: 4000
- Temperature: 250°F
- 3/8", Smooth, Blue
- SO / SW Couplers Included

PART NO.	OLD NO.	LENGTH	TEMPERATURE	WORKING PSI	APPROX WT (LBS)
3/8" Smooth Blue Hose					
8.739-229.0	154415	50'	250° F	4000	17.0
8.739-231.0	154425	100'	250° F	4000	33.0
8.705-651.0*	154400	Must be purchased in 500 ft reels			

\*500 ft reel, 50 ft incremental lengths (max three pieces)

**HOSE - SMOOTH COVER**



- PSI: 4000
- Temperature: 250°F
- 3/8", Wrapped, Grey

PART NO.	LENGTH	DESCRIPTION	TEMPERATURE	PSI
3/8" Smooth Cover, Grey Hose				
8.921-617.0	3/8" x 25'	4K Gray A+ SOXSW	250° F	4,000
8.921-618.0	3/8" x 50'	4K Gray A+ SOXSW	250° F	4,000
8.921-619.0	3/8" x 75'	4K Gray A+ SOXSW	250° F	4,000
8.921-620.0	3/8" x 100'	4K Gray A+ SOXSW	250° F	4,000
8.752-156.0	3/8" Bulk, 4K Gray	Must be purchased in 600 ft reels		250° F 4,000

### HOSE - LEGACY HOSES WITH COUPLING AND PLUG



- PSI: 4000 - 6000
- Temperature: 0°F
- Couplers and Plug Included

PART NO.	LENGTH	TEMPERATURE	WORKING PSI	APPROX WT (LBS)
3/8" Black Hose, R1				
8.928-928.0	50' x 3/8" ID	0° F	4000	?
8.928-929.0	100' x 3/8" ID	0° F	4000	?
3/8" Black Hose, R2				
8.928-930.0	50' x 3/8" ID	0° F	6000	?
8.928-931.0	100' x 3/8" ID	0° F	6000	?

### HOSE - A+ HOSES WITH COUPLING AND PLUG



- PSI: 4000
- Temperature: 0°F
- Couplers and Plug Included

PART NO.	LENGTH	TEMPERATURE	WORKING PSI	APPROX WT (LBS)
3/8" Blue Hose				
8.928-971.0	50' x 3/8" ID	0° F	4000	?
8.928-972.0	100' x 3/8" ID	0° F	4000	?
8.928-975.0	50' x 3/8" ID	0° F	4000	?
8.928-974.0	100' x 3/8" ID	0° F	4000	?

### HOSE - TUFF-FLEX - 2-WIRE



- PSI: 6000
- 3/8, Blue
- Temperature: 250°F
- Non-Marking Durable Blue Cover
- Red Hose Guard
- 50% Greater Flexibility
- 3/8" MPT Swivel x 3/8" MPT Solid
- Smooth impression, maximum oil-resistant tube and cover

PART NO.	LENGTH	TEMPERATURE	WORKING PSI
3/8" Tuff-Flex 2-Wire Blue Hose			
8.921-153.0	25' x 3/8" ID	250° F	6000
8.921-154.0	50' x 3/8" ID	250° F	6000
8.921-155.0	75' x 3/8" ID	250° F	6000
8.921-156.0	100' x 3/8" ID	250° F	6000
8.753-319.0	Must be purchased in 600 ft reels		



**HOSE - TUFF-FLEX - 1-WIRE**



- PSI: 4000
- 3/8, Blue
- Temperature: 250°F
- Non-Marking Durable Blue Cover
- Red Hose Guard
- 50% Greater Flexibility
- 3/8" MPT Swivel x 3/8" MPT Solid
- Smooth impression, maximum oil-resistant tube and cover

PART NO.	LENGTH	TEMPERATURE	WORKING PSI
3/8" Tuff-Flex 1-Wire Blue Hose			
8.921-149.0	25' x 3/8" ID	250° F	4000
8.921-150.0	50' x 3/8" ID	250° F	4000
8.921-151.0	75' x 3/8" ID	250° F	4000
8.921-152.0	100' x 3/8" ID	250° F	4000
8.753-316.0	Must be purchased in 600 ft reels		

**PRESSURE LOOP - 2-WIRE**

The 1/4" ID pressure lines solid / swivel for most any application. The 3/8" ID pressure loops have female JIC on both ends for typical unloader connection hose. All pressure loops are rated for 275° F.



- 1/4" ID Pressure Loop
- 1/4" MPT Swivel x 1/4" MPT Solid
- 1/4" ID Two-Wire, 5000 PSI
- Any Length Available



- JIC Pressure Loop
- 1/2" Female JIC Swivels - Each End
- 3/8" ID Two-Wire, 6000 PSI
- 1/2" ID 4500 PSI
- Any Length Available

PART NO.	OLD NO.	LENGTH	TEMPERATURE	PSI
1/4" Pressure Loop				
8.918-180.0		16" x 1/4" ID	250° F	6000
8.918-181.0		20" x 1/4" ID	250° F	6000
8.918-182.0		26" x 1/4" ID	250° F	6000
8.918-183.0		28" x 1/4" ID	250° F	6000
8.918-184.0		30" x 1/4" ID	250° F	6000
8.918-419.0		36" x 1/4" ID	250° F	6000
8.918-187.0		42" x 1/4" ID	250° F	6000
3/8" JIC Pressure Loop				
8.918-210.0		16" x 3/8" ID	250° F	6000
8.918-422.0		20" x 3/8" ID	250° F	6000
8.918-423.0		22" x 3/8" ID	250° F	6000
8.918-424.0		25" x 3/8" ID	250° F	6000
8.918-425.0		29" x 3/8" ID	250° F	6000
8.918-426.0		32" x 3/8" ID	250° F	6000
8.918-427.0		36" x 3/8" ID	250° F	6000
8.711-662.0	4-02047738	38" x 3/8" ID	250° F	6000
8.918-212.0		42" x 3/8" ID	250° F	6000
1/2" JIC Pressure Loop				
8.918-224.0		20" x 1/2" ID	275° F	4500
8.711-701.0	4-02067722	22" x 1/2" ID	275° F	4500
8.918-225.0		28" x 1/2" ID	275° F	4500
8.918-228.0		46" x 1/2" ID	275° F	4500
8.918-230.0		70" x 1/2" ID	275° F	4500

**HOSE - WHITEWATER® COMBINATION STEAM HOSE**



Good up to 3000 PSI - 250° F or 350 PSI - 325° F



- Single High-Tensile Steel Wire Braid
- High Temperature Bend Restrictors - Both Ends
- Seamless Innertube
- Solid 3/8" or 1/2" MPT Connectors - Both Ends (Swivel Ends NOT Available)
- Oil-Resistant Cover

PART NO.	OLD NO.	LENGTH	TEMPERATURE	WORKING PSI
3/8" Steam Hose				
8.901-559.0	153930	30'	325° F	3000
8.901-601.0	153950	50'	325° F	3000
8.901-598.0	153925	25'	325° F	3000
8.901-603.0	153975	75'	325° F	3000
8.901-604.0	153990	100'	325° F	3000
8.705-643.0	153900*	Must be purchased in 500 ft reels		
1/2" Steam Hose				
8.901-721.0	155625	25'	325° F	2500
8.901-723.0	155650	50'	325° F	2500
8.901-724.0	155675	75'	325° F	2500
8.901-725.0	155690	100'	325° F	2500
8.705-678.0	155600*	Must be purchased in 500 ft reels		

\*Full Reel - 500 ft per reel, hose only, 50 ft incremental lengths (max three pieces)

### PULSE HOSE



- PSI Working Pressure: 1300
- 3/8" MPT On Both Styles
- Available with either plug-end or open-flow with solid / swivel connects

PART NO.	OLD NO.	LENGTH	DESCRIPTION	WORKING PSI
8.711-151.0	381118	18"	w/ Plug End	1300
8.711-153.0	381124	24"	w/ Plug End	1300
8.711-155.0	381128	28"	Solid / Swivel - Open	1300
8.711-157.0	381136	36"	Solid / Swivel - Open	1300

### HOBBY HOSE

Replacement hose for most hobby pressure washers sold by mass retailers.



- PSI Working Pressure: 2250
- PSI Burst Pressure: 9000
- Thermoplastic Cover
- Fiber-braid Reinforcement
- M22 x 1.5 Fitting Inlet
- 14 mm Seal Cone Fits Generac, Excell and Kärcher
- 15 mm Seal Cone Fits Campbell, MI-T-M

PART NO.	OLD NO.	LENGTH	SEAL CONE	ID
8.705-485.0	150245	25'	14mm	1/4"
8.705-487.0	150246	25'	15mm	1/4"
8.753-423.0	4-02010025M	25'	22mm*	1/4"

### HOSE BEND RESTRICTORS



- Temperature: 325° F
- Used on Hose Assemblies
- Non-Slip Sure Fit
- Easy Installation
- Top-Quality Molded Fit Bend Restrictors
- Fits snugly to prevent kinks near the connectors

PART NO.	OLD NO.	LENGTH	TEMPERATURE	COLOR
1 Wire				
8.705-479.0	150166	5.3' x 1/4"	325° F	Black Vinyl
8.705-476.0	150161	6.0" x 1/2"	325° F	Black Vinyl
8.740-104.0		24.0" x 3/8"	325° F	Black Vinyl
8.756-784.0	150170	8.0" x 1/2"	325° F	Black Vinyl
2 Wire				
8.756-735.0		1/2" x 8"	325° F	Red Vinyl
8.705-478.0	150164	6.0" x 3/8"	325° F	Red Vinyl
8.711-846.0		24.0" x 3/8"	325° F	Red Vinyl
8.705-480.0	150168	7.0" x 3/8"	325° F	Red Vinyl
Combo				
8.705-483.0	150174	6.5" x 3/8" ID	325° F	Gray Vinyl
8.705-482.0*	150172	6.5" x 1/2" ID	325° F	Black Rubber

\*Insulated rubber

### GARDEN HOSE - APEX QUALITY

The essential product for pressure washing



- Rated For Cold-Water User
- Assemblies Complete With Bend Restrictor
- 5/8" or Larger ID For Full Flow
- Choice of Commercial or Heavy-Duty Grade
- Reinforced hose for flexibility and strength in all weather
- Commercial grade has machined octago-I "wrench tight" fittings

PART NO.	OLD NO.	LENGTH	GRADE	COLOR
8.704-786.0	121315	50' x 5/8" ID	Com	Gray
8.704-787.0	121319	100' x 5/8" ID	Com	Gray
8.704-788.0	121332	50' x 5/8" ID	HD	Light Green
8.704-789.0	121336	100' x 5/8" ID	HD	Light Green

All Rubber Reinforced Hot Water Hose - 160° F

8.704-790.0	121344	50' x 5/8" ID	Com	Red
8.704-791.0	121348	50' x 3/4" ID	Com	Red

See page 28 for garden hose fittings

### SEWER HOSE

Super flexible sewer line hose and couplings have small outside diameter, allowing hose and nozzles to fit through sewer line. Sewer line has super-tough poly-ether cover over ultra-flexible nylon tube. 1/8" sewer nozzle and hose will operate through many 1-12" lines.



- Max Temperature: 160° F
- 1.5 GPM Optimum Flow 1/8"
- 2.5 GPM Optimum Flow 1/4"
- Nylon Tube, Polyether Cover

Nozzles Not Included

PART NO.	OLD NO.	LENGTH	TEMPERATURE	GPM	PSI
1/8" Hose - 1/4" Inlet, 1/8" Outlet					
8.751-927.0	150960	1/8" x 25'	160° F	1.5	4800
8.705-602.0	150963	1/8" x 50'	160° F	1.5	4800
8.705-603.0	150964	1/8" x 100'	160° F	1.5	4800
1/4" Hose - 1/4" Inlet, 1/4" Outlet					
8.705-607.0	150968	1/4" x 50'	160° F	2.5	2600
8.705-608.0	150970	1/4" x 100'	160° F	2.5	2600
1/4" Hose - 1/4" Inlet, 1/4" Outlet					
8.705-610.0	150972	1/4" x 50'	160° F	2.5	4400
8.705-611.0	150973	1/4" x 100'	160° F	2.5	4400

## ORANGE 600 SPRAYER HOSE AND RIBBED PVC SPRAYER HOSE

Braid-reinforced PVC hose designed specifically for AG / Pest control spraying applications.



- Max PSI: 600
- Color: Orange
- Tough Ribbed Cover
- Bulk hose standard in 300' single length coils
- Resists Abrasion and UV Rays

PART NO.	OLD NO.	LENGTH	PSI
3/8" Hose - Orange			
8.705-527.0	150630	300' Coil, Single, Uncut Length	600
8.901-384.0	150634	50' Bulk	600
8.901-385.0	150636	100' Bulk	600
8.901-383.0	150632	Per Foot - 25' Minimum Hose Only	600
1/2" Hose - Orange			
8.705-523.0	150601	300' Coil, Single Uncut Length	600
8.901-377.0	150603	50' Bulk	600
8.901-379.0	150606	100' Bulk	600
8.705-524.0	150602	Per Foot - 25' Hose Only	600
3/4" Hose - Orange			
8.705-531.0	150660	1/4" x 50'	600
8.901-386.0	150660	1/4" x 100'	600

## COLD WEATHER GARDEN HOSE



- Ideal for outdoor contractors
- 5/8" - 50 ft
- High-Quality Brass Fittings
- Heated Hose with 110 Plug
- Thermostatically controlled - heating element is activated at +/- 35° F temperature and turned off at +/- 40° F ambient temperature
- Use only with a UL approved GFCI outlet or extension
- PVC material FDA-approved for potable water

PART NO.	LENGTH	DESCRIPTION
8.749-944.0	5/8" x 50'	Cold Weather Garden Hose

See page 28 for garden hose fittings

## VINYL TUBING

This 1/4" x 1/2" clear vinyl tubing is heavier duty than the rest! Thick wall resists kinking. Available in clear or clear-reinforced with polyester braid.



- Very Flexible
- Available by the foot or 100' rolls

PART NO.	OLD NO.	LENGTH	PSI	DESCRIPTION
9.802-251.0	4-02080000	1/4" x 1/2"	50	Clear Vinyl
9.802-252.0	4-02090000	1/4" x 1/2"	250	Braided Vinyl
8.711-733.0		3/8" x 1/2"	100	Sold by the foot

## CLEAR REINFORCED PVC TUBING

Multi-use, industrial-grade tubing with high-resistance to chemicals, solvents and fuel.



- Reinforced With Polyester Cord
- Huge Selection of Sizes and Lengths
- 4-to-1 Burst Safety Factor

PART NO.	OLD NO.	ID X OD	WP AT 70° F	ROLL LENGTH
8.901-256.0	121031	1/4" x 3/8"	250	25'
8.901-257.0	121032	1/4" x 3/8"	250	50'
8.704-751.0	121033	1/4" x 3/8"	250	100'
8.704-752.0	121034	1/4" x 3/8"	250	300'
8.901-260.0	121036	3/8" x 1/2"	175	25'
8.901-261.0	121037	3/8" x 1/2"	175	50'
8.901-262.0	121038	3/8" x 1/2"	175	100'
8.704-753.0	121039	3/8" x 1/2"	175	300'
8.901-264.0	121041	1/2" x 3/4"	175	25'
8.901-265.0	121042	1/2" x 3/4"	175	50'
8.704-754.0	121043	1/2" x 3/4"	175	100'
8.704-755.0	121044	1/2" x 3/4"	175	300'
8.901-263.0		1/2"	175	per ft
8.901-267.0	121046	5/8" x 7/8"	175	25'
8.901-268.0	121047	5/8" x 7/8"	140	50'
8.901-269.0	121048	5/8" x 7/8"	140	100'
8.704-756.0	121049	5/8" x 7/8"	140	300'
8.901-266.0		5/8"	140	per ft
8.901-271.0	121051	3/4" x 1"	140	25'
8.901-272.0	121052	3/4" x 1"	140	50'
8.704-757.0	121053	3/4" x 1"	140	100'
8.704-758.0	121054	3/4" x 1"	140	300'
8.901-270.0		3/4"	140	per ft
8.901-273.0	121059	1" x 1 1/4"	75	25'
8.901-274.0	121060	1" x 1 1/4"	75	50'
8.901-275.0	121061	1" x 1 1/4"	75	100'
8.704-759.0	121063	1" x 1 1/4"	75	200'
8.901-276.0		1"	75	per ft

See page 28 for hose clamps

## CRIMP FITTINGS



PART NO.	SIZE	HOSE
8.724-027.0	3/8" MPT, Solid	3/8"
8.724-028.0	3/8" MPT, Swivel	3/8"
8.724-029.0	1/2" FJIC, Solid	3/8"
8.706-759.0	3/8" FPT, Swivel	3/8"

## FIELD ATTACHABLE COUPLINGS

Designed and build your own hose or adapt and repair hose in the field (no crimper required).



PART NO.	OLD NO.	ID X MPT
1-Wire Braid Hose Couplings		
8.705-493.0	150502	1/4" x 1/4", Solid
8.705-495.0	150505	1/4" x 1/4", Swivel
8.705-496.0	150510	3/8" x 1/4", Solid
8.705-497.0	150511	3/8" x 3/8", Solid
8.705-498.0	150513	3/8" x 3/8", Swivel
8.705-499.0	150515	1/2" x 3/8", Solid
8.705-500.0	150516	1/2" x 1/2", Solid
8.705-501.0	150518	1/2" x 1/2", Swivel
2-Wire Braid Hose Couplings		
8.705-502.0	150532	1/4" x 1/4", Solid
8.705-503.0	150535	1/4" x 1/4", Swivel
8.705-505.0	150541	3/8" x 3/8", Solid
8.705-506.0	150543	3/8" x 3/8", Swivel
8.705-507.0	150546	1/2" x 1/2", Solid
8.705-508.0	150548	1/2" x 1/2", Swivel

## CLEAR PVC TUBING



- "Box Pak" 100 ft
- Temperature: 25° F to 150° F
- Very Flexible, Non-Reinforced
- Packaged in self-dispensing box

PART NO.	ID X OD	WP AT 70° F
8.901-279.0	1/4" x 3/8"	55
8.704-766.0	1/2" x 5/8"	30

## CONNECTOR HOSE - 2' - 10'

Connector hose comes with one solid - one swivel end.



PART NO.	LENGTH	PSI	HOSE COLOR
3/8" Ultima - 2-Wire - W/O Bend Restrictors			
8.918-271.0	2'	6000	Black
8.918-273.0	3'	6000	Black
8.918-276.0	4'	6000	Black
8.918-278.0	5'	6000	Black
8.918-280.0	6'	6000	Black
8.918-282.0	7'	6000	Black
8.918-284.0	8'	6000	Black
8.918-420.0	9'	6000	Black
8.918-288.0	10'	6000	Black
3/8" Ultima - 2-Wire - W/ Bend Restrictors			
8.918-272.0	2'	6000	Black
8.918-275.0	3'	6000	Black
8.918-277.0	4'	6000	Black
8.918-209.0	5'	6000	Black
8.918-281.0	6'	6000	Black
8.918-283.0	7'	6000	Black
8.918-285.0	8'	6000	Black
8.918-287.0	9'	6000	Black
8.918-289.0	10'	6000	Black
1/2" Ultima - 2-Wire - W/O Bend Restrictors			
8.918-292.0	2'	5000	Black
8.918-294.0	3'	5000	Black
8.918-296.0	4'	5000	Black
8.918-298.0	5'	5000	Black
8.918-300.0	6'	5000	Black
8.918-301.0	7'	5000	Black
8.918-302.0	8'	5000	Black
8.918-303.0	9'	5000	Black
8.918-304.0	10'	5000	Black

## FLEX LINE BYPASS / SUPPLY LINE HOSE

Industrial PVC hose with black seamless inner tube, polyester braid reinforced tough outer cover. Excellent for use as supply lines or bypass lines. Typically used for air hose.



- Looks and Feels Like Rubber
- Smooth Dirt and Oil Resistant Finish
- Super Flexible
- Abrasion-Resistant Cover
- Burst-Rated Three-Times WP

PART NO.	OLD NO.	ID X OD	WP AT 70° F	ROLL LENGTH
Red Cover, Heavy Wall				
8.901-281.0	21081	3/8" x .634"	300	50'
8.704-762.0	121084	3/8" x .634"	300	500'
8.901-282.0	121087	1/2" x .792"	250	50'
8.704-764.0	121090	1/2" x .792"	250	500'
8.901-284.0	121097	3/4" x 1.14"	160	50'
8.704-765.0	121099	3/4" x 1.14"	160	300'
Blue Cover, Standard Wall				
8.704-779.0	121160	1/4" x .475"	250	100'

**CONNECTOR HOSE - 2' - 10'**

Connector hose comes with one solid - one swivel end.



PART NO.	LENGTH	PSI	HOSE COLOR
3/8" Ultima - 1-Wire W/O Bend Restrictors			
8.918-253.0	2'	4000	Black
8.918-255.0	3'	4000	Black
8.918-257.0	4'	4000	Black
8.918-259.0	5'	4000	Black
8.919-261.0	6'	4000	Black
8.918-263.0	7'	4000	Black
8.918-265.0	8'	4000	Black
8.918-267.0	9'	4000	Black
8.918-269.0	10'	4000	Black

PART NO.	LENGTH	PSI	HOSE COLOR
1/4" Ultima - 1-Wire W/O Bend Restrictorss			
8.918-240.0	2'	4000	Black
8.918-241.0	3'	4000	Black
8.918-242.0	4'	4000	Black
8.918-243.0	5'	4000	Black
8.918-245.0	6'	4000	Black

**CONNECTOR HOSE - CAR WASH BAY HOSE - 12' - 25'**

All car wash bay hoses come with solid male pipe on both ends.



PART NO.	LENGTH	PSI
3/8" Ultima - 1-Wire W/O Bend Restrictors		
8.918-333.0	12'	4000
8.918-334.0	13'	4000
8.918-336.0	14'	4000
8.918-338.0	15'	4000
8.918-340.0	16'	4000
8.918-342.0	17'	4000
8.918-344.0	18'	4000
8.918-348.0	20'	4000
3/8" Ultima - 1-Wire W/ Bend Restrictors One End		
8.919-123.0	12'	4000
8.918-335.0	13'	4000
8.918-337.0	14'	4000
8.918-339.0	15'	4000
8.918-349.0	20'	4000
1/4" Blue - 1-Wire W/O Bend Restrictors		
8.918-389.0	13'	3000
8.918-391.0	14'	3000
8.918-393.0	15'	3000
8.918-395.0	16'	3000
8.918-397.0	17'	3000
8.918-399.0	18'	3000
8.918-401.0	19'	3000
8.918-403.0	20'	3000
8.918-409.0	23'	3000
8.918-411.0	24'	3000
8.918-413.0	25'	3000

PART NO.	LENGTH	PSI
3/8" Blue - 1-Wire W/O Bend Restrictors		
8.918-360.0	12'	3000
8.918-366.0	15'	3000
8.919-124.0	16'	3000
8.918-369.0	17'	3000
8.918-371.0	18'	3000
8.918-375.0	20'	3000
3/8" Blue - 1-Wire W/ Bend Restrictors One End		
8.918-367.0	15'	3000
8.918-368.0	16'	3000
8.918-372.0	18'	3000
8.918-376.0	20'	3000
1/4" Blue - 1-Wire W/ Bend Restrictors One End		
8.918-388.0	12'	3000
8.918-390.0	13'	3000
8.918-392.0	14'	3000
8.918-404.0	20'	3000



## LEGACY STACKABLE HOSE REELS



Hose reels built specifically for contractors who require flexibility on a job site. Stackable reels are supported on both sides of the central hub to accommodate more aggressive applications, such as trailer-mounted.



**200' Mild Steel Stackable Hose Reel**

**100' Mild Steel Stackable Hose Reel**

- Integrated frame adds protection and stacking ability
- Stacked up to 3 high
- Heavy-duty powder-coated steel or stainless steel
- Reel and swivel rated up to 6000 PSI and 350° F
- Modular design is able to configure for various needs
- Reversible hand-crank and swivel

PART NO.	DESCRIPTION
9.801-767.0	Stackable Hose Reel, Mild Steel, 100'
9.801-768.0	Stackable Hose Reel, Mild Steel, 200'
9.801-769.0	Stackable Hose Reel, Stainless-steel, 100'
9.801-770.0	Stackable Hose Reel, Stainless-steel, 200'
NOTE: Hose not included	
8.923-415.0	Hose Guide, 100' Reel
8.923-427.0	Hose Guide, 200' Reel
8.923-416.0	Hose Reel Riser
8.923-918.0	Reel Cart System



**Stainless-Steel Stackable Hose Reel**



**200' Mild Steel Stackable Hose Reel with Optional Hose Guide and Hose Reel Riser**



**200' Mild Steel Stackable Hose Reel with Optional Reel Cart System and Hose Guide**

**Options**



**Reel Cart System**



**Hose Reel Riser**

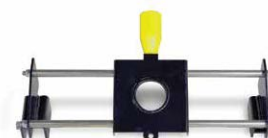

**Hose Guide**

**LEGACY HOSE REELS**



Legacy hose reels were designed for ease of use and durability in commercial pressure washer applications. Offering 100' and 200' reels in both a fixed base and 360 degree rotating base. The oversized reel holds the advertised length plus leaves additional space reducing the difficulty of reeling hose. The unique extended swivel improves the hose connection and reduces hose wear and stress.



**Fixed Base Hose Reel**



**360° Pivot Reel**

- PSI: 5000
- Temperature: 325° F
- 100' - 200' Fixed Base
- 100' - 200'; 360° Rotating Base
- High-Pressure, Double-Seal Swivels
- Reels equipped for 3/8" hose. Easily convertible to 1/2" hose with the change to a 1/2" swivel
- 2-Year Warranty

**Bracket Sockets**



**Universal Mount**



**Skid Mount**



**Wall Mount**



**Base Mount**

**Non-Pivot Reel Brackets**



**Universal**



**90°**



**45°**



**Vertical**

PART NO.	DESCRIPTION
8.750-485.0	Pivot Reel, 100' x 3/8", Hose Not Included
8.750-482.0	Pivot Reel, 200' x 3/8", Hose Not Included
8.750-476.0	Fixed Based, 100' x 3/8", Hose Not Included
8.750-479.0	Fixed Based, 200' x 3/8", Hose Not Included
8.919-430.0	Universal Mount
8.919-794.0	Skid Mount
8.919-437.0	Wall Mount
8.919-434.0	Base Mount
8.919-072.0	Bracket, Universal
8.919-445.0	Bracket, 90°
8.919-441.0	Bracket, 45°
8.919-448.0	Bracket, Vertical

**LEGACY HOSE REEL SWIVELS**



- PSI: 5000
- Innovative Design
- Stainless-Steel Rotor
- Unique Dual Seal for Extra Long Life
- 2-Year Warranty



- PSI: 5000
- Limits Bend and Hose Stress
- Stainless-Steel Rotor
- Unique Dual Seal for Extra Long Life
- 2-Year Warranty

PART NO.	INLET X OUTLET
Swivel	
9.118-021.0	1/2" x 3/8" F
8.776-003.0	1/2" F x 3/8" F
9.118-023.0	3/8" M x 3/8" F
9.118-024.0	3/8" F x 3/8" F
9.118-025.0	1/2" M x 1/2" F
9.118-026.0	1/2" x 1/2" F
9.118-027.0	3/8" M x 1/2" F
9.118-028.0	3/8" F x 1/2" F
Universal Repair Kit	
8.776-001.0	

PART NO.	INLET X OUTLET
Extended Swivels	
9.118-020.0	1/2" M x 3/8" F
9.118-029.0	1/2" F x 3/8" F
9.118-030.0	3/8" M x 3/8" F
9.118-031.0	3/8" F x 3/8" F
9.188-034.0	1/2" F x 1/2" F
9.118-035.0	1/2" M x 1/2" F
9.118-032.0	3/8" F x 1/2" F
9.118-033.0	3/8" M x 1/2" F
Universal Repair Kit	
8.776-001.0	

AP HOSE REELS



AP hose reels have been designed to perfectly balance ruggedness and durability with affordability.



- Working PSI: 4000
- Rated Temperature: 225° F
- 3/8" or 1/2" Inlet / Outlet
- Flared Flanges for Maximum Capacity
- Solid Center Core for Maximum Strength
- Rolled, Beaded-Edge Flanges for Maximum Safety
- Easy Mounting Options for Maximum Versatility
- "Posi-Pin" Lock Prevents Unwanted Dereeling
- Heavy-Duty Powder-Coated Steel
- Easy Access External Swivel

PART NO.	OLD NO.	HOSE DIAMETER	CAPACITY (FT)	CORE WIDTH	FLANGE WIDTH	FLANGE DIAMETER	OVERALL HEIGHT
8.711-192.0	386188	3/8"	50	4.3	7.9	10.5	13"
9.804-067.0	386191	3/8"	100	8.7	12.2	10.5	13"
8.711-199.0	386206	3/8"	150	6.3	10.2	13.0	16.7"
8.711-201.0	386209	1/2"	100	6.3	10.2	13.0	16.7"
8.712-460.0	421043	Replacement Swivel for Part No. 8.711-192.0 and 9.804-067.0					
8.712-469.0	421063	Replacement Swivel for Part No. 8.711-199.0					
8.754-280.0	421045	Replacement Swivel for Part No. 8.711-201.0					
8.700-188.0	4-0203612	Replacement Handle					
Swivel Repair Kits							
8.900-855.0	110025						

Note: Hose is not included. See page 140 for connector hose.



- Working PSI: 4000
- Rated Temperature: 225° F
- Super-Reinforced Core - Won't Collapse!
- Adjustable Brake for Controlled Reel Tension
- Convenient External Swivel
- Manual Rewind Handle Included
- Solid Core Bolts on to Flanges for Extra Strength
- Snap-Lock to Prevent Accidental Dereeling
- Bearings Have Oil Cap for Easy Field Maintenance

PART NO.	OLD NO.	HOSE DIAMETER	CAPACITY (FT)	REEL SIZE WIDTH	REEL SIZE DIAMETER
8.711-182.0	386174	3/8"	150	6"	18"
8.711-183.0	386175	3/8"	300	10"	18"
8.711-184.0	386176	3/8"	350	14"	18"
8.711-189.0	386181	1/2"	200	10"	18"
8.711-190.0	386182	1/2"	270	14"	18"
8.715-921.0	600975T	Replacement Brake for Part No. 8.711-182.0 and 8.711-183.0			

NOTE: Hose is not included. Interchangeable parts available. Call for pricing. See page 140 for connector hose.

PART NO.	OLD NO.	HOSE DIAMETER	CAPACITY (FT)	REEL SIZE WIDTH	REEL SIZE DIAMETER
8.711-179.0	386171	3/8"	90	6"	14"
8.711-180.0	386172	3/8"	140	10"	14"
8.711-181.0	386173	3/8"	200	14"	14"
8.711-186.0	386178	1/2"	115	10"	14"
8.711-187.0	386179	1/2"	150	14"	14"

NOTE: Hose is not included. Interchangeable parts available. Call for pricing. See page 140 for connector hose.

PART NO.	OLD NO.	HOSE DIAMETER	DESCRIPTION
8.700-287.0	075130	3/8"	Swivel Repair Kit
8.700-285.0	075128	1/2"	Swivel Repair Kit
8.900-855.0*	110025		Swivel Repair Kit

\*For Round Swivels. Replacement Swivels, See Page 24

**COXREELS HOSE REELS**

Coxreels offer high performance in a very compact and lightweight hand crank or spring-driven hose reel. Perfect for mobile application and permanent floor and wall mount.



**8.711-858.0**

- Rated Up to 4000 PSI
- Temperature: -20° F to 225° F
- Adjustable Drag Brake
- 90° Brass Swivel



**9.802-265.0**

- Spring Driven Hose Reel
- Lightweight, Compact Design
- Adjustable Drag Break
- Sturdy U-Shaped Frame
- PSI: Up To 4000
- Rolled edges and ribbed dics provide strength and safety
- Pro-Grade Heavy-Duty Steel
- 2-Year Mfg Limited Warranty



**8.723-649.0**  
(Hose and Ball Stop Not Included)

PART NO.	OLD NO.	PSI	DESCRIPTION
8.711-858.0	4-0275001	3000	200' x 1/2" (300' x 3/8" w/ Adapter)
8.711-860.0	4-02750002	4000	100' x 3/8"
9.802-265.0	4-02750003	4000	150' x 3/8"
8.711-591.0	4-020369		Handle Replacement
8.711-588.0	4-020366		Locking Pin Assembly
8.723-649.0	87236490	4000	50' x 3/8" Spring Driven
8.705-132.0	140407		1/2" to 3/8" Adapter for 8.711-858.0
8.750-020.0			Ball Stop for 8.723-649.0
8.711-584.0	4-020362		Replacement Swivel, 1/2"
8.711-585.0	4-020363		Replacement Swivel, 3/8"

**QUICK COUPLERS**



Brass Couplers, designed for 4000 PSI and extended durability. Affordable and rugged all in one.



- PSI Max: 4000
- Precision Brass Design
- Stainless-Steel Band for Increased Durability (Except 1/2")
- Unrestricted Free-Flow

PART NO.	OLD NO.	DESCRIPTION	CASE LOT PART NO
9.802-164.0	2-2000	1/4" FPT 8.916-538.0	Case of 200 Couplers
9.802-166.0	2-2002	3/8" FPT 8.916-537.0	Case of 200 Couplers
8.707-166.0	2-20180	1/2" FPT	
9.802-165.0	2-2001	1/4" MPT 8.916-542.0	Case of 200 Couplers
9.802-169.0	2-2003	3/8" MPT 8.916-541.0	Case of 200 Coupler
8.707-167.0	2-20181	1/2" MPT	
CASE LOT PART NO	DESCRIPTION	CASE LOT PART NO	
8.916-538.0	1/4" FPT	Case of 200 Couplers	
8.916-537.0	3/8" FPT	Case of 200 Couplers	
8.916-542.0	1/4" MPT	Case of 200 Couplers	
8.916-541.0	3/8" MPT	Case of 200 Couplers	

Steel Nipples, hardened steel combined with zinc yellow chromate plating holds up to the harshest environments.



- PSI Max: 4000
- Zinc-Plated
- Hardened Steel

PART NO.	OLD NO.	DESCRIPTION	CASE LOT PART NO
8.707-136.0	2-2004	1/4" FPT 8.916-361.0	Case of 200 Nipples
8.707-137.0	2-20040	1/4" x 1/8" FPT	
9.802-170.0	2-2006	3/8" FPT 8.916-536.0	Case of 200 Nipples
8.707-165.0	2-2018	1/2" FPT	
8.707-139.0	2-2005	1/4" MPT 8.916-540.0	Case of 200 Nipples
9.802-171.0	2-2007	3/8" MPT 8.916-539.0	Case of 200 Nipples
8.707-164.0	2-2017	1.2" MPT	
CASE LOT PART NO	DESCRIPTION	CASE LOT PART NO	
8.916-361.0	1/4" FPT	Case of 200 Nipples	
8.916-536.0	3/8" FPT	Case of 200 Nipples	
8.916-540.0	1/4" MPT	Case of 200 Nipples	
8.916-539.0	3/8" MPT	Case of 200 Nipples	

**QUICK CONNECTIVE COUPLERS - FOSTER**



- Precision Performance
- Unrestricted Bore for Free Flow
- Resists plug deformation when pressure spikes occur and withstands pump pulse



**QUICK COUPLERS STAINLESS-STEEL**



- PSI: 6000
- 303 Stainless-Steel
- Chemical-Resistant

PART NO.	OLD NO.	DESCRIPTION	TYPE
8.707-110.0	2-2001SS	1/4" MPT Couplers	Stainless-steel
8.707-135.0	2-2003SS	3/8" MPT Couplers	Stainless-steel
8.707-140.0	2-20051	1/4" MPT Nipples	Stainless-steel
8.707-152.0	2-20071	3/8" MPT Nipples	Stainless-steel
8.707-103.0	2-2000SS	1/4" FPT Couplers	Stainless-steel
8.707-125.0	2-2002SS	3/8" FPT Couplers	Stainless-steel
8.707-138.0	2-20041	1/4" FPT Nipples	Stainless-steel
8.707-144.0	2-20061	3/8" FPT Nipples	Stainless-steel

**O-RINGS**



- O-Rings for AP, Hansen, Foster, Parker and quick-coupler brands. Buna to 210° F, EPDM to 280° F and Viton to 300° F and aggressive chemicals.

**QC EPDM**

PART NO.	OLD NO.	QC SIZE
8.701-981.0	075033	1/8"
9.802-098.0	075035	1/4"
9.802-102.0	075037	3/8"

**QC BUNA**

PART NO.	OLD NO.	QC SIZE
8.702-015.0	075034	1/4"
8.702-017.0	075036	3/8"
8.702-021.0	075038	1/2"

**QC BUNA**

PART NO.	OLD NO.	QC SIZE
8.702-084.0	075042	1/4"
8.702-088.0	075041	3/8"
8.702-090.0	075040	1/2"

PART NO.	DESCRIPTION	TYPE
8.756-030.0	1/4" Socket, Coupler, Male	Brass
8.756-031.0	1/4" Socket, Coupler, Female	Brass
8.756-032.0	3/8" Socket, Coupler, Male	Brass
8.756-033.0	3/8" Socket, Coupler, Female	Brass
8.756-034.0	1/2" Socket, Coupler, Female	Brass
8.756-035.0	1/4" Plug, Coupler, Female	Steel
8.756-036.0	1/4" Plug, Coupler, Female	Steel
8.756-037.0	3/8" Plug, Coupler, Male	Steel
8.756-038.0	3/8" Plug, Coupler, Female	Steel
8.756-039.0	3/8" Plug, Coupler, Male	Stainless-steel
8.756-040.0	3/8" Plug, Coupler, Female	Stainless-steel
8.756-041.0	1/2" Plug, Coupler, Male	Steel
8.756-042.0	1/2" Plug, Coupler, Female	Steel



**COUPLERS - QUICK CONNECTIVE**

SERIES	STEEL PLUG BRASS PLUG		STAINLESS-STEEL
	PSI	PSI	PSI
1/8"	2600	2500	4200
1/4"	5500	5200	6700
3/8"	3500	2700	6300
1/2"	2700	2200	3000
3/4"	1700	1700	1700

OLD NO.	OLD NO.	DESCRIPTION	TYPE
8.709-436.0	331010	1/8" MPT Coupler Socket	Brass
8.709-463.0	331045	3/4" MPT Coupler Socket	Brass
8.709-462.0	331044	3/4" FPT Coupler Socket	Brass
8.709-438.0	331012	1/8" MPT Coupler Socket	Stainless-steel
8.709-566.0	331415	3/8" MPT Coupler Socket	Stainless-steel
8.709-564.0	331413	3/8" FPT Coupler Socket	Stainless-steel
8.709-457.0	331031	1/2" FPT Coupler Socket	Stainless-steel
8.709-478.0	331110	1/8" MPT Plugs	Steel, Zinc-plated
8.709-479.0	331111	1/8" FPT Plugs	Steel, Zinc-plated
8.709-502.0	331127	3/4" MPT Plugs	Steel, Zinc-plated
8.709-509.0	331144	3/4" FPT Plugs	Steel, Zinc-plated
8.709-486.0	331117	1/4" MPT Plugs	Hardened Stainless-steel
8.709-488.0	331118	1/4" FPT Plugs	Hardened Stainless-steel
8.709-480.0	331112	1/2" MPT Plugs	Hardened Stainless-steel
8.709-481.0	331113	1/2" FPT Plugs	Hardened Stainless-steel

**COUPLERS - TWIST SEAL**

Allows U.S. standard hose to connect to 22 mm European fittings.



**Not Threaded**

- PSI Max: 3600
- GPM: 7.8
- Temperature Max: 302° F
- Internal O-Ring Seal
- Machined-Brass Body
- High-Impact Plastic Knob
- Not Threaded

PART NO.	OLD NO.	DESCRIPTION	TYPE	PSI MAX
8.709-522.0	331205	1/4" FPT	Machined-brass body	3600
8.709-530.0	331207	3/8" FPT	Machined-brass body	3600
9.802-173.0	331204	1/4" MPT	Machined-brass body	3600
8.709-526.0	331206	3/8" MPT	Machined-brass body	3600
8.709-601.0	331710	3/8" QD Plug	Machined-brass body	3600
8.709-554.0		3/8" QD Plug	Machined-brass body	3600

Plugs are made of heavy-duty machined-brass for a safe and leak-free connection.



**O-Rings, Viton**

PART NO.	OLD NO.	DESCRIPTION	TYPE	PSI MAX
8.709-540.0	331305	1/4" FPT	Machined-brass	3600
8.709-546.0	331307	3/8" FPT	Machined-brass	3600
8.709-536.0	331304	1/4" MPT	Machined-brass	3600
8.707-185.0	331306	3/8" MPT	Machined-brass	3600

PART NO.	OLD NO.	DESCRIPTION	TYPE	PSI MAX
8.756-782.0		O-rings (Viton)		

**QUICK COUPLERS**

Snaptite Quick Sockets and Plugs are precision-built for extreme high pressure.



- PSI Max: 11,000
- Temperature: -40° F to 205° F
- Zinc Chromate

PART NO.	OLD NO.	DESCRIPTION	TYPE	PSI MAX
8.707-115.0	2-20023	1/4" FPT Socket	Zinc Chromate	11,000
8.707-116.0	2-200231	1/4" MPT Socket	Zinc Chromate	11,000
9.802-167.0	2-20021	3/8" FPT Socket	Zinc Chromate	11,000
8.707-117.0	2-20024	1/4" FPT Plug	Zinc Chromate	11,000
8.707-121.0	2-20028	1/4" MPT Plug	Zinc Chromate	11,000
9.802-168.0	2-20022	3/8" FPT Plug	Zinc Chromate	11,000
8.707-120.0	2-20027	3/8" MPT Plug	Zinc Chromate	11,000
9.804-043.0	2-0132	1/4" SEAL, U-Pack	Zinc Chromate	11,000
8.706-712.0	2-01321	3/8" SEAL, U-Pack	Zinc Chromate	11,000

**COUPLERS - TWIST SEAL**

Couples U.S. standard pipe threads to 22 mm European fittings found on imported pressure washers.



**Sockets**

- PSI Max: 4000, GPM: 7.8
- Temperature Max: 302° F
- 3.9 to 4.2 Oz Weight
- Internal O-ring with back ring seal assures no-leak operation
- Oversized High-Impact Plastic Knob
- Machined-Brass Body

PART NO.	OLD NO.	DESCRIPTION	TYPE	PSI MAX
8.709-524.0	331205PA	1/4" FPT	Machined-brass body	4000
8.709-531.0	331207PA	3/8" FPT	Machined-brass body	4000
8.709-534.0	331209PA	1/2" FPT	Machined-brass body	4000
8.709-521.0	331204PA	1/4" MPT	Machined-brass body	4000
8.709-528.0	331206PA	3/8" MPT	Machined-brass body	4000
8.709-533.0	331208PA	1/2" MPT	Machined-brass body	4000



**Plugs**

PART NO.	OLD NO.	DESCRIPTION	TYPE	PSI MAX
8.709-542.0	331305PA	1/4" FPT	Machined-brass body	4000
8.709-548.0	331307PA	3/8" FPT	Machined-brass body	4000
8.709-553.0	331309PA	1/2" FPT	Machined-brass body	4000
8.709-539.0	331304PA	1/4" MPT	Machined-brass body	4000
8.709-551.0	331308PA	1/2" MPT	Machined-brass body	4000



**O-Rings**

PART NO.	OLD NO.	DESCRIPTION
8.704-036.0	109286	O-rings, 22 mm Viton
8.704-037.0	109287	Back Ring, 2.4 x 9.3



### COUPLER - EXTENDED TWIST SEAL



- PSI: 3600
- GPM: 11
- Temperature: 300° F
- Double O-Ring Seal
- Machined-Brass Body
- High-Impact Plastic Knob

PART NO.	OLD NO.	DESCRIPTION	PSI MAX
8.709-535.0	331215	1/4" FPT x 22 mm, Female, Coupler	3600
8.709-555.0	331315	1/4" FPT x 22 mm, Male, Plug	3600

### DOUBLE SHUT-OFF COUPLERS AND PLUGS



- Quick disconnect without drips and leaks
- Indispensable for in-plant multiple station systems
- Machined-construction brass, zinc-plated steel or stainless steel

PART NO.	OLD NO.	DESCRIPTION	TYPE	PSI MAX
8.709-556.0	331401	1/8" FPT Socket	Brass	3000
8.756-043.0	331405	1/4" FPT Socket	Brass	2700
8.756-044.0	331406	3/8" FPT Socket	Stainless-steel, Zinc	3700
8.709-559.0	331407	3/8" FPT Socket	Brass	2200
8.709-560.0	331408	1/2" FPT Socket	Brass	2250
8.709-561.0	331409	1/2" FPT Socket	Stainless-steel	4250
8.709-562.0	331410	3/4" FPT Socket	Brass	2000
8.709-580.0	331501	1/8" FPT Plugs	Brass	3000
8.709-583.0	331507	3/8" FPT Plugs	Brass	2200
8.709-584.0	331508	1/2" FPT Plugs	Brass	2250
8.709-582.0	331506	3/8" FPT Plugs	Steel, Zinc	2250

### FOSTER DOUBLE SHUT-OFF QUICK COUPLERS



PART NO.	DESCRIPTION	TYPE
8.756-043.0	1/4" FPT, Coupler Socket, Double Shut Off	Brass
8.756-044.0	1/4" FPT, Coupler Plus, Double Shut Off	Brass



Replacement O-Rings

- Nitrile Up to 210° F
- Use Viton for 230° F and Above

PART NO.	OLD NO.	DESCRIPTION	TYPE	MAX TEMP
8.701-994.0	ORN013	1/8" O-ring	Nitrile	Up To 210° F
8.702-015.0	ORN110	1/4" O-ring	Nitrile	Up To 210° F
8.702-017.0	ORN112	3/8" O-ring	Nitrile	Up To 210° F
8.702-021.0	ORN114	1/2" O-ring	Nitrile	Up To 210° F
8.702-084.0	ORN110	1/4" O-ring	Viton	230° F and Above
8.702-088.0	ORV112	3/8" O-ring	Viton	230° F and Above
8.702-090.0	ORV114	1/2" O-ring	Viton	230° F and Above
8.702-023.0	ORN115	3/32" O-ring	Nitrile (For Kit 1)	230° F and Above

Specifications, product descriptions and product availability subject to change without notice.

### QUICK COUPLERS - BRASS

Designated for 4000 PSI and extended durability. EPDM O-rings as standard. Affordable and rugged all in one.



PART NO.	DESCRIPTION	PSI
8.750-695.0	1/4" Socket FPT, Coupler	4000
8.750-696.0	1/4" Socket MPT, Coupler	4000
8.750-697.0	3/8" Socket FPT, Coupler	4000
8.750-698.0	3/8" Socket MPT, Coupler	4000

### SWIVELS - 90°

Excellent for car wash booms and hose reels. Remarkable value, comparable to best swivels made.



- PSI: 4000
- Temperature: 225° F
- Forged-Brass Body
- Nitrile O-Ring

PART NO.	OLD NO.	DESCRIPTION	PSI MAX
8.712-460.0	421043	3/8" M x 3/8" F	4000
8.712-461.0	421044	3/8" F x 3/8" F	4000
8.712-462.0	421045	1/2" M x 1/2" F	4000
8.712-463.0	421046	1/2" F x 1/2" F	4000
8.712-464.0	421047	1/2" M x 3/8" F	4000
8.712-469.0	421063	3/8" F x 3/4" M w 3/8" Inside thread	4000
8.900-855.0	110025	Repair Kit	4000

### SWIVELS - RIGHT ANGLE



- PSI Max: 3000 (Brass)
- PSI Max: 5000 (Stainless-Steel)
- 360° Swivel Rotation



PART NO.	OLD NO.	DESCRIPTION	TYPE
8.712-448.0	421018	3/8" Swivel	Stainless-steel
8.712-450.0	421020	3/8" Swivel	Brass
8.712-449.0	421019	1/2" Swivel	Brass
8.700-287.0	075143	3/8" Repair Kit for 8.712-448.0, 8.712-450.0	
8.700-285.0	075128	1/2" Repair Kit for 8.712-449.0	

### SWIVELS - STAINLESS-STEEL, HIGH-PRESSURE AND ECONOMY BRASS



- GPM Max: 10.5 (Stainless-Steel)
- GPM Max: 7.8 (Brass)
- Temperature: 320° F (Stainless-Steel)
- Temperature: 195° F (Brass)
- Highly Resistant to Harsh Chemicals
- "Live" Swivel at Full Pressure
- 6 Oz Weight

PART NO.	OLD NO.	DESCRIPTION	PSI MAX
8.712-456.0	421030	1/4" M x F, Swivel	5600
8.712-455.0	421025	3/8" M x F, Swivel	5600
8.712-443.0	421009	3/8" M x F, Swivel	3600
8.704-096.0	109542	Repair Kit for 8.712-456.0, 8.712-455.0	

### GUN SWIVEL



Made of corrosion-resistant material and stainless-steel, self-lubricated bearings, the new gun swivel offers highest-quality Swiss-made craftsmanship.



- PSI: 4000
- Temperature: 250° F
- GPM: 30

PART NO.	OLD NO.	DESCRIPTION	PSI MAX
8.712-467.0	421057	1/4" NPTF, Gun Swivel	4000
8.712-466.0	421056	3/8" NPTF, Gun Swivel	4000

### SWIVELS



- PSI: 3000
- Brass Housing
- Stainless-Steel Flow-Through Bolt
- Close-tolerance fit ensures leakproof seal
- Teflon® Ring Provides Free Swivel

PART NO.	OLD NO.	DESCRIPTION	TYPE	PSI MAX
8.904-551.0	421010A	3/8" MPT x FPT*	Brass	3000
8.904-552.0	421012A	3/8" FPT x FPT*	Brass	3000
8.904-554.0	421015	3/8" FPT x FPT	Brass	3000
8.900-764.0	109198	Seal Kit		
8.900-765.0	109199	Rebuild Kit		

\*Long body style

### SWIVELS - STAINLESS-STEEL



- PSI: 4000
- Temperature: 200° F
- All Stainless Construction
- Teflon® Swivel Ring
- Rebuildable
- 3/8" In and Out

PART NO.	OLD NO.	DESCRIPTION	TYPE	PSI MAX
8.712-446.0	421016	3/8" MPT x FPT	Stainless-steel	4000
8.712-447.0	421017	3/8" FPT x FPT	Stainless-steel	4000
8.900-764.0	109198	Seal Kit		
8.900-765.0	109199	Rebuild Kit		

### SWIVELS - BALL BEARING

Swivels freely even at maximum pressure level noted below.



8.712-438.0

8.712-479.0

- MPT x FPT All Sizes
- Brass and Stainless-Steel Materials

PART NO.	OLD NO.	DESCRIPTION	TYPE	PSI MAX
8.712-438.0	421004	1/4"	Brass, Stainless-steel	2000
8.712-439.0	421005	1/4"	Brass, Stainless-steel	3500
8.712-440.0	421006	3/8"	Brass, Stainless-steel	2000
8.712-441.0	421007	3/8"	Brass, Stainless-steel	3500
8.712-479.0	421080	1/4" 90°	Brass, Stainless-steel	3500
8.700-263.0	075060	Repair Kit		

### SWIVELS - STAINLESS-STEEL BALL BEARING



- PSI Max: 3500
- Temperature: 180° F
- Hardened, Stainless-Steel Body
- Nitrile Buna Seals
- M x F NPT Thread
- Ball-bearing design ensures free swivel action under pressure
- Suitable for extended-wear applications

PART NO.	OLD NO.	DESCRIPTION	TYPE	GPM	PSI MAX
8.712-457.0	421034	1/4"	Stainless-steel	6.8	3500
8.700-460.0	076102	Repair Kit for 8.712-457.0			
8.712-458.0	421036	3/8"	Stainless-steel	10.6	3500
8.700-459.0	076101	Repair Kit for 8.712-458.0			
8.712-459.0	421038	1/2"	Stainless-steel	27.0	3500
8.700-461.0	076103	Repair Kit for 8.712-459.0			

### ADAPTERS - BRASS



PART NO.	OLD NO.	DESCRIPTION	TYPE
8.705-186.0	140651	1/8" x 1/8"	Brass
9.803-054.0	140652	1/4" x 1/8"	Brass
8.705-188.0	140653	1/4" x 1/4"	Brass
8.705-185.0	140650	3/8" x 1/8"	Brass
9.804-007.0	140654	3/8" x 1/4"	Brass
8.705-190.0	140655	3/8" x 3/8"	Brass
8.705-192.0	140657	1/2" x 1/4"	Brass
8.705-191.0	140656	1/2" x 3/8"	Brass
9.802-148.0	140658	1/2" x 1/2"	Brass
8.705-194.0	140660	3/4" x 1/2"	Brass
8.705-195.0	140662	3/4" x 3/4"	Brass

### BUSHINGS - BRASS



PART NO.	OLD NO.	DESCRIPTION	TYPE
9.803-564.0	140402	1/4" x 1/8"	Brass
8.705-129.0	140404	3/8" x 1/4"	Brass
9.804-015.0		3/8" x 1/8"	Brass
9.802-135.0	140406	1/2" x 1/4"	Brass
8.705-132.0	140407	1/2" x 3/8"	Brass
8.705-133.0	140410	3/4" x 3/8"	Brass
9.802-136.0	140411	3/4" x 1/2"	Brass

### HEX COUPLINGS - BRASS



PART NO.	OLD NO.	DESCRIPTION	TYPE
8.705-150.0	140452	1/8"	Brass
8.705-151.0	140454	1/4"	Brass
8.705-152.0	140456	3/8"	Brass
8.705-153.0	140458	1/2"	Brass
8.705-154.0	140462	3/4"	Brass

### HEX COUPLINGS - REDUCING - BRASS



PART NO.	OLD NO.	DESCRIPTION	TYPE
8.705-155.0	140502	1/4" x 1/8" F	Brass
8.705-156.0	140504	3/8" x 1/4" F	Brass
8.705-157.0	140505	1/2" x 1/4" F	Brass
8.705-158.0	140506	1/2" x 3/8" F	Brass
8.705-159.0	140508	3/4" x 1/2" F	Brass

### HEX NIPPLES - DOUBLE - BRASS



PART NO.	OLD NO.	DESCRIPTION	TYPE
8.705-224.0	140752	1/8" x 1/8" M	Brass
9.802-108.0	140754	1/4" x 1/4" M	Brass
8.705-228.0	140756	3/8" x 3/8" M	Brass
9.803-989.0	140758	1/2" x 1/2" M	Brass
8.705-233.0	140762	3/4" x 3/4" M	Brass
8.705-234.0	140764	1" x 1" M	Brass

### JIC SWIVELS



9.802-151.0

PART NO.	DESCRIPTION	TYPE
9.802-153.0	1/4" Barb x 1/4" JIC FPT	Brass
9.802-151.0	1/2" Barb x 1/2" JIC FPT	Brass
9.802-152.0	3/4" Barb x 3/4" JIC FPT	Brass
9.802-048.0	1/2" JIC FPT x 3/8" MPT	Steel
8.706-315.0	1/2" JIC FPT x 1/2" MPT	Steel

### NIPPLES - BRASS



Close Nipple



PART NO.	OLD NO.	DESCRIPTION	TYPE
8.705-201.0	2-1000	1/8" Close	Brass
8.705-204.0	2-1002	1/4" Close	Brass
8.705-211.0	2-1004	3/8" Close	Brass
9.802-109.0	2-1006	1/2" Close	Brass
8.705-220.0	2-1008	3/4" Close	Brass
8.705-202.0	140703	1/8" x 1-1/2"	Brass
8.705-203.0	140705	1/8" x 2-1/2"	Brass
8.705-205.0	140711	1/4" x 1-1/2"	Brass
8.705-206.0	140712	1/4" x 2"	Brass
8.705-207.0	2-1010	1/4" x 2-1/2"	Brass
8.705-212.0	140721	3/8" x 1-1/2"	Brass
8.705-213.0	140723	3/8" x 2-1/2"	Brass
8.705-214.0	2-10051	3/8" x 3"	Brass
8.705-217.0	140731	1/2" x 1-1/2"	Brass
8.705-218.0	140733	1/2" x 3"	Brass
8.705-221.0	140742	3/4" x 2"	Brass
8.705-222.0	140744	3/4" x 3"	Brass

### HEX REDUCING NIPPLES - BRASS



PART NO.	DESCRIPTION	TYPE
8.705-225.0	1/4" x 1/8" M	Brass
8.705-223.0	3/8" x 1/8" M	Brass
8.705-227.0	3/8" x 1/4" M	Brass
8.705-229.0	1/2" x 1/4" M	Brass
9.803-276.0	1/2" x 3/8" M	Brass
9.803-556.0	3/4" x 1/2" M	Brass

**ELBOWS - 90° - BRASS**



PART NO.	OLD NO.	DESCRIPTION	TYPE
8.705-160.0	140552	1/8" FPT	Brass
8.705-161.0	2-1018	1/4" FPT	Brass
9.802-113.0	2-1019	3/8" FPT	Brass
9.803-265.0	2-1020	1/2" FPT	Brass
8.705-164.0	2-1021	3/4" FPT	Brass
8.705-169.0	140584	1/4" x 1/4" MPT	Brass
8.705-171.0	140586	3/8" x 3/8" MPT	Brass
8.705-173.0	140588	1/2" x 1/2" MPT	Brass
9.802-129.0	2-1060	1/2" JIC x 3/8" MPT	Brass
9.802-031.0	2-1062	1/2" JIC x 1/2" MPT	Brass
Reducing Elbows			
8.705-165.0	2-10410	1/4" FPT x 1/8" FPT	Brass
8.705-166.0	140577	3/8" FPT x 1/4" FPT	Brass
8.705-168.0	140583	1/4" x 1/8" MPT	Brass
8.705-167.0	140582	3/8" x 1/8" MPT	Brass
8.705-170.0	140585	3/8" x 1/4" MPT	Brass
8.705-172.0	140587	1/2" x 3/8" MPT	Brass

**JIC X PIPE NIPPLES**



PART NO.	DESCRIPTION
8.706-265.0	1/2" JIC x 1/4" FPT
9.802-037.0	1/2" JIC x 3/8" FPT
9.802-036.0	1/2" JIC x 3/8" MPT
9.802-038.0	1/2" JIC x 1/2" MPT

**STREET ELBOWS - BRASS**



PART NO.	DESCRIPTION	TYPE
90° Street Elbows		
8.705-174.0	1/8" M x F	Brass
9.803-839.0	1/4" M x F	Brass
9.802-114.0	3/8" M x F	Brass
9.802-115.0	1/2" M x F	Brass
9.803-555.0	3/4" M x F	Brass
45° Street Elbows		
8.705-180.0	1/8" M x F	Brass
8.705-181.0	1/4" M x F	Brass
8.705-182.0	3/8" M x F	Brass
8.705-183.0	1/2" M x F	Brass
8.705-184.0	3/4" M x F	Brass

**EXTRUDED OR FORGED TEES - BRASS**



PART NO.	DESCRIPTION	TYPE
8.705-246.0	1/8" F	Brass
8.705-247.0	1/4" F	Brass
8.705-248.0	3/8" F	Brass
9.802-117.0	1/2" F	Brass
8.705-251.0	3/4" F	Brass

**MALE BRANCH TEES - BRASS**



PART NO.	DESCRIPTION	TYPE
9.802-120.0	1/4"	Brass
8.705-254.0	3/8"	Brass
8.705-255.0	1/2"	Brass

**STREET TEES - BRASS**



PART NO.	DESCRIPTION	TYPE
9.802-121.0	1/4"	Brass
8.705-257.0	3/8"	Brass
9.802-122.0	1/2"	Brass
8.705-259.0	3/4"	Brass

**FEMALE CROSSES - BRASS EXTRUDED**



PART NO.	DESCRIPTION	TYPE
8.705-196.0	1/4"	Brass
8.705-197.0	3/8"	Brass
8.705-198.0	1/2"	Brass
8.705-199.0	3/4"	Brass



### CHECK HOSE BARBS



- 1/4" MPT x 1/4" Barb
- Brass Body
- Buna or Viton Check Ball

PART NO.	OLD NO.	DESCRIPTION	TYPE
8.904-389.0	385128	Check Hose Barb - Viton	Brass Body
8.904-390.0	385129	Check Hose Barb - Buna	Brass Body

### JIC NIPPLES - BRASS



9.802-128.0



8.706-894.0

PART NO.	DESCRIPTION	TYPE
8.706-872.0	1/2" JIC x 1/4" MPT	Brass
9.802-127.0	1/2" JIC x 3/8" MPT	Brass
9.802-128.0	1/2" JIC x 1/2" MPT	Brass
8.706-877.0	1/2" JIC x 3/4" MPT	Brass
8.706-894.0	1/2" JIC x 1/2" FPT	Brass
8.706-895.0	1/2" JIC x 3/8" FPT	Brass
8.706-896.0	1/2" JIC x 1/4" FPT	Brass
8.706-897.0	1/2" JIC x 3/4" FPT	Brass
8.706-899.0	3/4" JIC x 3/4" Pipe MPT	Brass
8.706-971.0	1/2" JIC x 3/4" GHF	Brass

### PUSH-N-LOCK BARBS



Normally requires no clamps



Barb x Barb

PART NO.	OLD NO.	DESCRIPTION	TYPE
Barb x MPT			
8.705-069.0	140252	1/4" x 1/8"	Brass
8.705-070.0	140254	1/4" x 1/4"	Brass
8.705-071.0	140255	1/4" x 3/8"	Brass
8.705-072.0	140256	3/8" x 1/8"	Brass
8.705-073.0	140257	3/8" x 1/4"	Brass
8.705-074.0	140258	3/8" x 3/8"	Brass
8.705-075.0	140259	3/8" x 1/2"	Brass
8.705-076.0	140260	3/8" x 3/4"	Brass
8.705-077.0	140261	1/2" x 1/4"	Brass
9.802-156.0	140262	1/2" x 3/8"	Brass
8.705-079.0	140263	1/2" x 1/2"	Brass
8.705-080.0	140264	1/2" x 3/4"	Brass
8.705-081.0	140265	5/8" x 3/8"	Brass
8.705-082.0	140266	5/8" x 1/2"	Brass
8.705-083.0	140267	5/8" x 3/4"	Brass
8.705-084.0	140268	3/4" x 1/2"	Brass
8.705-085.0	140269	3/4" x 3/4"	Brass
Barb x Barb			
8.705-064.0	140200	1/4" x 1/4"	Brass
8.705-065.0	140204	3/8" x 3/8"	Brass
8.705-066.0	140208	1/2" x 1/2"	Brass
8.705-067.0	140210	5/8" x 5/8"	Brass
8.705-068.0	140212	3/4" x 3/4"	Brass

Specifications, product descriptions and product availability subject to change without notice.

### HOSE BARBS - BRASS



90° Barb x MPT



Barb x MPT

PART NO.	OLD NO.	DESCRIPTION	TYPE
Barb x MPT - 90°			
9.802-142.0	140369	1/4" x 1/8"	Brass
9.802-143.0	140370	1/4" x 1/4"	Brass
8.705-118.0	140371	3/8" x 1/4"	Brass
8.705-119.0	140372	3/8" x 3/8"	Brass
8.705-120.0	140374	3/8" x 1/2"	Brass
8.705-121.0	140375	1/2" x 1/4"	Brass
8.705-122.0	140376	1/2" x 3/8"	Brass
8.705-123.0	140377	1/2" x 1/2"	Brass
8.705-125.0	140379	5/8" x 3/8"	Brass
8.705-126.0	140384	5/8" x 1/2"	Brass
Barb x MPT			
8.705-097.0	140350	1/8" x 1/4"	Brass
9.802-137.0	140352	1/4" x 1/8"	Brass
9.802-138.0	140354	1/4" x 1/4"	Brass
8.705-102.0	140355	1/4" x 3/8"	Brass
8.705-108.0	140361	1/4" x 1/2"	Brass
8.705-098.0	140351	3/8" x 1/8"	Brass
8.705-104.0	140357	3/8" x 1/4"	Brass
8.705-105.0	140358	3/8" x 3/8"	Brass
8.705-103.0	140356	3/8" x 1/2"	Brass
8.705-100.0	140353	3/8" x 3/4"	Brass
8.705-110.0	140363	1/2" x 1/4"	Brass
8.705-106.0	140359	1/2" x 3/8"	Brass
8.705-109.0	140362	1/2" x 1/2"	Brass
8.705-111.0	140364	1/2" x 3/4"	Brass
8.705-107.0	140360	5/8" x 3/8"	Brass
9.802-140.0	140365	5/8" x 1/2"	Brass
8.705-113.0	140366	5/8" x 3/4"	Brass
8.705-114.0	140367	3/4" x 1/2"	Brass
8.705-115.0	140368	3/4" x 3/4"	Brass
Barb x FPT			
8.706-949.0		1/4" x 1/4"	Brass

### SWIVEL HOSE BARBS - LOW PRESSURE



- PSI Max: 300
- Temperature: 210° F
- Brass MPT base with steel hose barb
- Swivel easily at low pressure to eliminate twists and tangles in chemical or water lines

PART NO.	OLD NO.	DESCRIPTION	TYPE
8.705-050.0	140079	1/4" x 1/4"	Brass MPT, Steel Hose Barb
8.705-052.0	140081	3/8" x 3/8"	Brass MPT, Steel Hose Barb
8.705-053.0	140083	1/2" x 1/2"	Brass MPT, Steel Hose Barb

**ORIFICED HOSE BARB**



- 3/8" MPT x 5/8" Barb
- Used in-line from float tank to pump
- One-Piece, Machined-Brass
- Inexpensive way to create suction on inlet side of pump
- Standard orifice 5/32" - drill up to 3/8" to fit your need

PART NO.	OLD NO.	DESCRIPTION	TYPE
8.705-093.0	140320	Orificed Hose Barb	Machined Brass

**DRAIN COCKS**



PART NO.	OLD NO.	DESCRIPTION
8.705-060.0	140125	1/4" Fuel Drain w/ Tee Handle
8.705-061.0	140127	1/4" Fuel Drain w/ Barb and Tee Handle

**HEX HEAD PLUGS**



PART NO.	OLD NO.	DESCRIPTION
8.705-236.0	140802	1/8"
8.705-238.0	140804	1/4"
8.705-240.0	140806	3/8"
9.803-673.0	140808	1/2"
8.705-244.0	140810	3/4"

**ALLEN HEAD PLUGS**



PART NO.	OLD NO.	DESCRIPTION
9.803-051.0	140802A	1/8"
9.802-124.0	140804A	1/4"
8.705-241.0	140806A	3/8"
8.705-243.0	140808A	1/2"

**HEX SOCKET HEAD PLUGS**



PART NO.	OLD NO.	DESCRIPTION
8.705-041.0	140062	1/8"
8.705-042.0	140064	1/4"
8.705-043.0	140065	3/8"
8.705-044.0	140067	1/2"
8.705-045.0	140070	3/4"

**GARDEN HOSE FITTINGS**



**8.901-292.0**



**8.705-034.0**

- MGH = Male Garden Hose
- FGH = Female Garden Hose
- Heavy-Duty, Machined-Brass Fittings



**8.709-460.0**



**9.804-016.0**



**9.802-145.0**



**8.705-087.0**

PART NO.	OLD NO.	DESCRIPTION
Swivel Fittings - 3/4" FGH		
8.705-032.0	140050	1/4" MPT
8.901-292.0	140056	3/8" MPT
8.901-291.0	140051	1/2" MPT
8.705-033.0	140052	3/2" FPT (S-1)
9.802-146.0		3/4" FGH Swivel w / 1/2" MPT Strainer
8.705-034.0	140054	3/4" FPT (S-2)
8.705-035.0	140055	3/4" FGH (S-3)
8.705-008.0	140002	1/2" Barb
8.705-009.0	140004	5/8" Barb
8.705-010.0	140006	3/4" Barb
Garden Hose Quick Couplers		
8.709-460.0	331040	Female Hose Coupler
8.709-508.0	331140	Male Hose Plug
Garden Hose Accessories		
8.705-016.0	140020	Garden Hose Washer
9.804-016.0	140015	Filter Screen Washer (30-mesh)
Solid Fittings		
8.705-024.0	140036	3/4" MGH x 3/8" MPT
9.802-145.0	140038	3/4" MGH x 1/2" MPT
8.705-026.0	140040	3/4" MGH x 3/4" MPT
8.705-019.0	140028	3/4" FGH x 1/2" FPT
8.705-020.0	140030	3/4" FGH x 3/4" FPT
8.705-022.0	140032	3/4" FGH x 1/2" MPT
8.705-023.0	140034	3/4" FGH x 3/4" MPT
8.705-018.0	140026	3/4" FGH x 3/4" FGH (Stainless-steel)
Hose Barb Fittings		
8.705-086.0	140301	3/8" Barb x 3/4" MGH
8.705-087.0	140303	1/2" Barb x 3/4" MGH
8.705-088.0	140305	5/8" Barb x 3/4" MGH
8.705-089.0	140307	3/4" Barb x 3/4" MGH
8.705-091.0	140317	3/8" Barb x 3/4" FGH
8.705-092.0	140319	1/2" Barb x 3/4" FGH
8.705-094.0	140321	5/8" Barb x 3/4" FGH
8.705-095.0	140323	3/8" Barb x 3/4" FGH

## HOSE CLAMPS

WARNING: LOW-PRESSURE USE ONLY!  
Not for use on pressure washer discharge hose.



- Stainless-Steel Band and Housing
- Worm Gear Tensions



- Nylon "Speedi-Clamp" tightens with a snap
- Releases with a twist

PART NO.	OLD NO.	BAND	OD	MIN - MAX
9.802-200.0	358010	4 mm	5/16"	.25 - .63
8.710-456.0	358012	5 mm	5/16"	.38 - .88
8.710-457.0	358013	10 mm	5/16"	.50 - 1.06
8.710-458.0	358015	H8	1/2"	.44 - .91
8.710-459.0	358018	H10	1/2"	.56 - 1.06
8.710-460.0	358019	H12	1/2"	.69 - 1.25
8.710-461.0	358020	H16	1/2"	.75 - 1.50
8.710-464.0	358024	H32	1/2"	1.56 - 2.50
6.390-126.0		Red Spring Clamp		.466 - .54
8.709-116.0		Green Spring Clamp		.40 - .48
8.904-167.0*	358001X	1/4" ID Speedi-Clamp		
8.904-168.0*	358004X	3/8" ID Speedi-Clamp		
8.904-169.0*	358006X	1/2" ID Speedi-Clamp		

\*50/pk

## ZINC-PLATED HEAVY WALL STEEL PIPE FITTINGS

- Up to 6000 PSI Working Pressure (18,000 PSI Burst)
- Attractive Zinc-Plated Protective Coating
- U.S. Standard Taper Pipe Threads

## ADAPTERS - STEEL



PART NO.	OLD NO.	DESCRIPTION	PSI	TYPE
8.705-356.0	142404	1/4" x 1/4"	6000	Steel
8.705-357.0	142405	1/4" x 3/8"	6000	Steel
9.804-553.0	142406	3/8" x 3/8"	6000	Steel
8.705-359.0	142407	3/8" x 1/2"	6000	Steel
8.705-360.0	142408	1/2" x 1/2"	6000	Steel
8.705-361.0	142409	1/2" x 3/4"	6000	Steel
8.705-362.0	142412	3/4" x 3/4"	6000	Steel

## HEX COUPLING - STEEL



PART NO.	OLD NO.	DESCRIPTION	PSI
8.705-364.0	142415	1/4" x 1/4"	6000
8.705-366.0	142417	3/8" x 3/8"	6000
8.705-369.0	142420	1/2" x 1/2"	5000
8.705-371.0	142422	3/4" x 1/2"	5000
Reducing Couplings			
8.705-365.0	142416	3/8" x 1/4"	6000
8.705-367.0	142418	1/2" x 3/8"	5000
8.705-368.0	142419	1/2" x 1/4"	5000
8.705-370.0	142421	3/4" x 1/2"	4000

## HEX NIPPLE - STEEL



PART NO.	OLD NO.	DESCRIPTION	PSI
9.802-010.0	142425	1/4" x 1/4"	6000
9.802-011.0	142427	3/8" x 3/8"	6000
9.802-012.0	142430	1/2" x 1/2"	6000
8.705-380.0	142434	3/4" x 3/4"	6000
9.802-022.0	142426	3/8" x 1/4"	6000
8.705-375.0	142428	1/2" x 1/4"	6000
8.705-376.0	142429	1/2" x 3/8"	6000
8.705-379.0	142431	3/4" x 1/2"	6000

## STREET ELBOW - STEEL



PART NO.	OLD NO.	DESCRIPTION	PSI
9.802-029.0	142438	1/4" x 1/4"	6000
9.804-080.0	142439	1/4" x 3/8"	6000
9.802-030.0	142440	3/8" x 3/8"	6000
8.705-384.0	142441	3/8" x 1/2"	6000
9.803-045.0	142442	1/2" x 1/2"	6000
8.705-386.0	142443	1/2" x 3/4"	6000
8.705-387.0	142444	3/4" x 3/4"	6000

## ELBOWS - 45°



PART NO.	DESCRIPTION
8.706-278.0	3/8" x 3/8", 45°
8.706-277.0	1/4" x 1/4", 45°

**STREET TEE - STEEL**



PART NO.	OLD NO.	DESCRIPTION	PSI
8.705-428.0	142684	1/4"	5000
9.802-033.0	142685	3/8"	4500
9.802-034.0	142686	1/2"	3000
8.705-431.0	142687	3/4"	3000

**ELBOW - STEEL**



PART NO.	OLD NO.	DESCRIPTION	PSI
8.706-176.0		1/4" x 1/8"	4500
8.705-393.0	142504	1/4" x 1/4"	5000
8.705-394.0	142505	1/4" x 3/8"	4500
9.802-023.0	142506	3/8" x 3/8"	4500
8.705-396.0	142507	3/8" x 1/2"	3000
8.705-397.0	142508	1/2" x 1/2"	3000
8.705-398.0	142509	1/2" x 3/4"	4000
8.705-399.0	142512	3/4" x 3/4"	4000
9.802-039.0	2-0053	1/2" JIC x 3/8" MPT	5000
9.802-040.0		1/2" JIC x 1/2" MPT	5000
9.802-130.0		1/2" JIC x 1/4" MPT	5000
8.706-906.0		1/2" JIC x 3/4" FPT	5000

**TEE - 3 CONNECTS**



PART NO.	OLD NO.	DESCRIPTION	PSI
8.705-412.0	142654	1/4" FPT	5000
8.705-414.0	142656	3/8" FPT	4500
8.706-216.0	142658	1/2" FPT	3000
8.705-417.0	142662	3/4" FPT	3000
8.706-213.0		1/4" MPT	

**CROSS - 4 CONNECTS**



PART NO.	OLD NO.	DESCRIPTION	PSI
8.705-418.0	142664	1/4" FPT	5000
8.705-419.0	142666	3/8" FPT	4500
8.705-420.0	142668	1/2" FPT	3000
8.705-421.0	142672	3/4" FPT	3000

**REDUCING BUSHING - STEEL**



PART NO.	OLD NO.	DESCRIPTION	PSI	TYPE
9.802-046.0	142676	3/8" x 1/4"	6000	Steel
8.705-423.0	142678	1/2" x 1/4"	6000	Steel
9.802-045.0	142680	1/2" x 3/8"	6000	Steel
8.705-426.0	142682	3/4" x 1/2"	6000	Steel

**HEX PIPE PLUGS - STEEL**



PART NO.	OLD NO.	DESCRIPTION	PSI	TYPE
9.803-530.0	142701	1/4"	6000	Steel
8.705-433.0	142702	3/8"	6000	Steel
8.705-434.0	142703	1/2"	6000	Steel
8.705-435.0	142704	3/4"	6000	Steel

**PIPE NIPPLE - ZINC**



PART NO.	OLD NO.	DESCRIPTION	PSI	TYPE
9.803-043.0	142800	2" x 1/4"	6000	Zinc
8.705-441.0	142801	3" x 1/4"	6000	Zinc
8.705-442.0	142802	4" x 1/4"	6000	Zinc
8.705-443.0	142803	2" x 3/8"	6000	Zinc
8.705-985.0	142804	3" x 3/8"	6000	Zinc
8.705-445.0	142805	4" x 3/8"	6000	Zinc
8.705-446.0	142806	2" x 1/2"	6000	Zinc
9.802-014.0	142807	3" x 1/2"	6000	Zinc
9.802-015.0	142808	4" x 1/2"	6000	Zinc
8.705-996.0	142808T	5" x 1/2"	6000	Zinc
8.705-450.0	142810	2" x 3/4"	6000	Zinc
8.705-451.0	142811	3" x 3/4"	6000	Zinc
8.705-452.0	142812	4" x 3/4"	6000	Zinc
8.705-453.0	142813	6" x 3/4"	6000	Zinc

## GALVANIZED PIPE FITTINGS

- Pressed-Steel Fittings - external galvanized for excellent chemical resistance
- Ideal for supply line (city water pressure) applications (working pressure rating of 125 PSI)
- NOT recommended for high-pressure piping applications

## PIPE STREET ELBOWS



PART NO.	OLD NO.	DESCRIPTION
8.705-407.0	142604	1/4" MPT x FPT
8.705-408.0	142606	3/8" MPT x FPT
8.705-409.0	142608	1/2" MPT x FPT
8.705-410.0	142610	3/4" MPT x FPT

## PIPE TEES



PART NO.	OLD NO.	DESCRIPTION
8.705-456.0	142854	1/4" FPT x FPT x FPT
8.705-458.0	142856	3/8" FPT x FPT x FPT
8.705-459.0	142858	1/2" FPT x FPT x FPT
8.705-461.0	142868	3/4" FPT x FPT x FPT

## MERCHANT COUPLING



PART NO.	OLD NO.	DESCRIPTION
8.705-389.0	142454	1/4" FPT x FPT
8.705-390.0	142456	3/8" FPT x FPT
8.705-391.0	142458	1/2" FPT x FPT

## BANDED COUPLING



PART NO.	OLD NO.	DESCRIPTION
8.705-436.0	142754	1/4" FPT x FPT
8.705-437.0	142756	3/8" FPT x FPT
8.705-438.0	142758	1/2" FPT x FPT
8.705-439.0	142760	3/4" FPT x FPT

## ELBOWS - 90°



PART NO.	OLD NO.	DESCRIPTION
8.705-403.0	142552	1/4" FPT x FPT
8.705-404.0	142556	3/8" FPT x FPT
8.705-405.0	142558	1/2" FPT x FPT
8.705-406.0	142560	3/4" FPT x FPT

## FILTER - "THE BIG ONE"



Excellent for car wash booms and hose reels. Remarkable value, comparable to best swivels made.



- PSI: 4000
- Temperature: 225° F
- Forged-Brass Body
- Nitrile O-Ring

PART NO.	OLD NO.	DESCRIPTION
8.709-938.0	340025	W/ Check Valve
8.709-939.0	340026	W/Out Check Valve

## CHEMICAL FILTER - BRASS



50-mesh, stainless-steel screen. Removable mesh for easy cleaning. Heavy-duty, one-piece brass body holds the filter on the bottom of tank.



- 1/4" Hose Barb
- Stainless-Steel Check Ball

PART NO.	OLD NO.	DESCRIPTION
9.803-672.0	340010X	W/ Check Valve
8.709-934.0	340012X	W/Out Check Valve

## CHEMICAL STRAINER - PLASTIC

Polypropylene and brass construction.



- 7 mm Hose Barb

PART NO.	OLD NO.	DESCRIPTION
8.709-935.0	340014	W/ Check Valve
9.802-160.0	340015	W/Out Check Valve

## CHEMICAL LINE WITH FILTER



- 6-Foot Long, 1/4" Clear Vinyl Tubing

PART NO.	OLD NO.	DESCRIPTION	TYPE
8.903-991.0	340022X	Chemical Line, Filter w/ Check Valve	Brass Filter
8.903-993.0	340024X	Chemical Line, Filter w/ Check Valve	Plastic Filter
8.903-996.0	340027X	Chemical Line, Filter w/o Check Valve	Plastic Filter



**FILTERS - HEAVY-DUTY IN-LINE**



- PSI Max: 145
- GPM Max: 8
- Temperature Max: 140° F
- 1/2" Female x Male
- 50-Mesh Screen
- Unbreakable Reinforced Nylon Cap

PART NO.	OLD NO.	DESCRIPTION	MAX PSI
8.709-974.0	342026	Filter	145
8.709-975.0	342027	W/Auxiliary Bypass Port	145
8.704-172.0	109941	Replacement Filter	145

**IN-LINE FILTER - GREEN-CAP**



The original Green-Cap!



- PSI Max: 145
- GPM Max: 6
- 40-Mesh Stainless Screen
- Diecast Metal Housing / Plastic Cap
- 1/2" FPT Inlet
- 1/2" MPT Outlet
- Two 1/4" Side Ports

PART NO.	OLD NO.	DESCRIPTION	MAX PSI
8.709-961.0	342010	Green Cap Filter	145
8.701-383.0	083441	Replacement Screen	145
8.701-382.0	083439	Replacement Cap	145
8.702-034.0	083440	Replacement O-Ring	145

**IN-LINE FILTER - ALL METAL**



- PSI Max: 170
- GPM Max: 6.6
- Temperature Max: 195° F
- 38-Mesh Screen
- Diecast Aluminum Body and Cover
- Black Anodized Finish
- 1/2" Female x Male

PART NO.	OLD NO.	DESCRIPTION	MAX PSI
8.709-976.0	342030	All Metal Line Filter	170
8.704-055.0	109343	Replacement Filter	170

**FLITERS - CLEAR BOWL**



- Low-Profile Style
- MPT Inlet and Outlet
- White Nylon Body
- Clear Bowl
- Stainless-Steel Screen
- L3" L x 1-3/4" W x 2-3/8" H

PART NO.	OLD NO.	DESCRIPTION	COLOR
8.709-962.0	342012	1/4", 40-Mesh Screen	Clear Bowl
8.709-963.0	342013	1/4", 80-Mesh Screen	Clear Bowl
8.709-964.0	342014	3/8", 40-Mesh Screen	Clear Bowl
8.709-965.0	342015	3/8", 80-Mesh Screen	Clear Bowl
8.709-966.0	342016	1/2", 40-Mesh Screen	Clear Bowl
8.709-967.0	342017	1/2", 80-Mesh Screen	Clear Bowl
8.700-563.0	078214	80-Mesh Replacement Screen	Clear Bowl
8.700-564.0	078215	40-Mesh Replacement Screen	Clear Bowl

**IN-LINE CAN-TYPE FILTERS AND PARTS**



- 40-or-80 Mesh Filtration
- Heavy-duty molded plastic with stainless-steel screen
- Hanger tab standard on 3/8", 1/2" and 3/4"
- Choose Black or Clear Filter Cans

PART NO.	OLD NO.	DESCRIPTION	COLOR
<b>40-Mesh Filters</b>			
8.709-982.0	342105	3/8" Hanger Tab	Black
8.709-986.0	342110	1/2" Hanger Tab	Black
8.709-990.0	342115	3/4" Hanger Tab	Black
8.709-994.0	342120	1" Hanger Tab	Black
8.710-001.0	342150	1-1/4" Hanger Tab	Black
8.710-003.0	342155	1-1/2" Hanger Tab	Black
8.709-983.0	342106	3/8" Hanger Tab	Clear
8.709-987.0	342111	1/2" Hanger Tab	Clear
8.709-991.0	342116	3/4" Hanger Tab	Clear
8.709-996.0	342123	1" Hanger Tab	Clear
8.710-002.0	342151	1-1/4" Hanger Tab	Clear
8.710-004.0	342156	1-1/2" Hanger Tab	Clear
<b>80-Mesh Filters</b>			
8.709-988.0	342112	1/2" Hanger Tab	Black
8.709-992.0	342117	3/4" Hanger Tab	Black
8.709-995.0	342122	1" Hanger Tab	Black
8.710-005.0	342158	1-1/4" Hanger Tab	Black
8.709-999.0	342147	1-1/2" Hanger Tab	Black
8.709-989.0	342113	1/2" Hanger Tab	Clear
8.709-993.0	342118	3/4" Hanger Tab	Clear
8.709-997.0	342125	1" Hanger Tab	Clear
8.710-006.0	342159	1-1/4" Hanger Tab	Clear
8.710-000.0	342149	1-1/2" Hanger Tab	Clear
<b>In-Line Can-Type Filter Parts - 3/8", 1/2", 3/4"</b>			
8.700-555.0	078202	Gasket	
8.700-557.0	078204	Viton Gasket	
8.700-559.0	078207	Bowl	Black
8.700-560.0	078208	Bowl	Clear
8.700-565.0	078216	40-Mesh Screen, Blue	
8.700-567.0	078220	80-Mesh Screen, White	
8.932-949.0	078223	3/8" Top w/Tab	
8.700-569.0	078224	1/2" Top w/Tab	
8.700-570.0	078225	3/4" Top w/Tab	
<b>In-Line Can-Type Filter Parts - 1", 1-1/4", 1-1/2"</b>			
8.700-556.0	078203	Gasket	
8.700-558.0	078205	Viton Gasket	
8.700-566.0	078217	1", 40-Mesh Screen	
8.700-575.0	078233	1-1/4", 40-Mesh Screen	
8.700-576.0	078234	1-1/2", 40-Mesh Screen	
8.700-568.0	078221	1", 80-Mesh Screen	
8.700-577.0	078237	1-1/4", 80-Mesh Screen	
8.700-578.0	078238	1-1/2", 80-Mesh Screen	
8.700-571.0	078226	1" Filter Top	
8.700-572.0	078227	1-1/4" Filter Top	
8.700-573.0	078230	1", 1-1/4", 1-1/2" Bowl	Black
8.700-574.0	078231	1", 1-1/4", 1-1/2" Bowl	Clear

### IN-LINE CLEARVIEW FILTER



**8.710-145.0**      **8.710-146.0**      **8.710-147.0**

- Stainless-Steel Screen
- Combination 1/2", 3/4" Hose Barb
- Weighted to hold at bottom of tank or source

PART NO.	OLD NO.	DESCRIPTION
8.710-145.0	347091	3/8" NPT x 3/4" GH
8.710-147.0	347093	3/8" NPT x 3/4" GH w/ 1/4" Bypass
8.710-144.0	347090	1/2" NPT x 3/4" GH
8.710-146.0	347092	1/2" NPT x 3/4" GH w/ 1/3" Byass

### Y-TRAP STRAINER



- PSI Max: 170
- Temperature Max: 194° F
- Brass Bodies and Cap
- FPT Inlet and Outlet
- Stainless-Steel 50-Mesh Cylinder Screen

PART NO.	OLD NO.	DESCRIPTION	TYPE	MAX PSI
8.709-956.0	342004	1/4" FPT	Brass Bodies and Cap	170
8.709-957.0	342006	3/8" FPT	Brass Bodies and Cap	170
8.709-958.0	342007	1/2" FPT	Brass Bodies and Cap	170
8.709-959.0	342008	3/4" FPT	Brass Bodies and Cap	170
8.709-960.0	342009	1" FPT	Brass Bodies and Cap	170

### CHECK / FOOT VALVE

Includes backflow check and perforated screen, prevents damage to pump or control valves.



- Removable Stainless-Steel Screen
- Spring-Loaded Check Valve
- Cast-Brass Bodies
- FPT Outlet

PART NO.	OLD NO.	DESCRIPTION	TYPE
8.709-388.0	310882	1/2" Foot Check Valve and Screen	
8.709-389.0	310883	3/4" Spring Check Valve	Brass
8.709-390.0	310884	1" Spring Check Valve	Brass
8.709-391.0	310886	1-1/2" Spring Check Valve	Brass
8.709-392.0	310888	2" Spring Check Valve	Brass

### SUCTION FOOT VALVE - ST35/35R



- Stainless-Steel Screen
- Combination 1/2", 3/4" Hose Barb
- Weighted to hold at bottom of tank or source

PART NO.	OLD NO.	DESCRIPTION	TYPE
8.709-970.0	342021	W/Check Valve	Stainless-steel Screen

### TANK SCREEN / STRAINER



- Stainless-Steel Screen - 40 or 50 Mesh
- PVC Base, attaches to nipple or tubing
- Use for tank drain or chemical line

PART NO.	OLD NO.	DESCRIPTION	MESH
8.710-008.0	342304	1/4" FPT	50
8.710-010.0	342306	3/8" FPT	50
8.710-011.0	342307	1/2" FPT	40
9.802-162.0	342308	1/2" FPT	50
8.710-013.0	342311	3/4" FPT	40
8.710-014.0	342312	3/4" FPT	50
8.710-015.0	342316	1" FPT	40
8.710-016.0	342320	1-1/2" FPT	40

### IN-LINE HIGH-PRESSURE NOZZLE FILTERS

Protect your turbo nozzle from damage caused by debris in the water flow.



**8.709-978.0**



**8.710-149.0**



**8.709-979.0**



**8.710-150.0**

- PSI Max: 5000
- Temperature: 300° F
- 1/4" MPT Outlet
- 100 Mesh Screen

PART NO.	OLD NO.	DESCRIPTION	TYPE
8.709-978.0	342040	1/4" FPT Inlet x 1/4" MPT Outlet	Brass
8.709-979.0	342042	1/4" QC Inlet x 1/4" MPT Outlet	Brass
8.710-149.0	347097	1/4" QC Inlet x 1/4" MPT Outlet	416 SS
8.710-150.0	347098	1/4" MPT Inlet x 1/4" MPT Outlet	Brass
8.704-234.0	110595	Replacement filter for 8.709-978.0 / 8.709-979.0	
8.701-201.0	080115	Replacement filter for 8.710-149.0 / 8.710-150.0	

**FILTER AND PARTS - HIGH-VOLUME**

Molded plastic housing



- PSI Max: 125
- GPM Max: 12 at 50 Micron
- GPM Max: 10 at 5 or 20 Micron
- 3/4" FPT Inlet and Outlet
- 14-1/2" Tall x 5-1/2" Port to Port

PART NO.	OLD NO.	DESCRIPTION	MAX PSI
8.710-017.0	342375	Housing only	125
8.905-569.0	565375X	Mounting Bracket / Hardware	125
8.700-581.0	078280	Replacement O-ring	125



- Pleated Ployester / Polypropylene Core
- Recommended for large flow, low- pressure applications (up to 60 PSI)

PART NO.	OLD NO.	DESCRIPTION	GPM
Ultra Fine Filter Elements			
8.710-019.0	342380	5 Micron	10
8.710-020.0	342382	20 Micron	10
8.710-021.0	342384	50 Micron	12



- Recommended for maximum filtration with reduced flow requirements (up to 130 PSI)

PART NO.	OLD NO.	DESCRIPTION	GPM
Synthetic String Wound Elements			
8.710-022.0	342387	5 Micron	4
8.710-023.0	342389	20 Micron	5
8.710-024.0	342391	50 Micron	6

**FUEL FILTERS**

In-line, disposable



**8.709-942.0**



**9.802-211.0**

PART NO.	OLD NO.	DESCRIPTION	TYPE
9.802-211.0	341001	1/4" Inlet / Outlet	Plastic
8.709-942.0	341002	1/4" Inlet / Outlet	Metal
8.709-943.0	341003	3/8" Inlet / Outlet	Plastic

**CLEAR BOWL FUEL FILTER**



- Aluminum Housing
- Non-replaceable 120 mesh stainless-steel screen
- 1/4" x 1/4"
- Clear Acrylic Bowl

PART NO.	OLD NO.	DESCRIPTION
8.709-948.0	341013	Complete Unit

**FUEL FILTER / WASH SEPARATOR** 



- 10 Micron Filtration
- Spin-On Convenience
- Water-Separation Chamber
- 1/4" FPT Inlet / Outlet
- Easy Drain Water / Sediment Bowl

PART NO.	DESCRIPTION
8.725-306.0	Complete Unit
8.725-307.0*	Element Only

\*Order 24 for a full case

**BLUE TOP FILTER**



PART NO.	DESCRIPTION	TYPE
8.753-559.0	Housing, 5", 1/2" F-F	
8.753-561.0	Housing, 5", 1" F-F	
8.753-562.0	Housing, 10", 1/2" F-F	
8.753-563.0	Housing, 10", 3/4" F-F	
8.753-564.0	Cartridge, 10" Poly Thread	Disposable
8.753-565.0	Cartridge, 5" Nylon Mesh	Disposable
8.753-566.0	Cartridge, 10" Nylon Mesh	Washable
8.753-567.0	Cartridge, 5" Nylon Mesh	Washable

## FUEL FILTER / WATER SEPARATOR **RACOR**

The "Max" fuel system protector



- 10 Micron Filtration
- Spin-On Convenience
- Water-Separation Chamber
- 1/4" FPT Inlet / Outlet
- Easy Drain Water / Sediment Bowl

PART NO	OLD NO.	DESCRIPTION
9.802-212.0	341040	Complete Unit
8.709-953.0	341042	Element
8.700-553.0	078127	Plastic Bowl

## GENERAL FUEL FILTER ELEMENT



- Can Type
- GPM Max: 10
- 10 Micron Filtration
- Inexpensive Replacement
- Wool Felt Element

PART NO.	OLD NO.	DESCRIPTION
8.709-950.0	341017	Element

## RACOR FILTER FUNNEL **RACOR**



- GPM: 3.9
- Teflon-Coated, Stainless-Steel Filter
- Separates free water and contaminants from gasoline / diesel / kerosene

PART NO.	OLD NO.	DESCRIPTION
8.709-955.0	341044	Racor Filter Funnel

**NOZZLE SIZE SELECTION CHART**

Determine the nozzle size by the pressure washer's GPM @ PSI (gallons per minute @ a specific pounds per square inch). If the nozzle size is too small, your equipment can be damaged. If the nozzle size is too large, cleaning ability is compromised. Nozzle fan degree does not effect nozzle size selection.

STANDARD NOZZLE SIZE	HOLE SIZE	POUNDS PER SQUARE INCH (PSI)																
		500	750	1000	1250	1500	1750	2000	2250	2500	2750	3000	3250	3500	3750	4000	4500	5000
2	.034"/0.86mm	0.71	0.87	1.00	1.12	1.22	1.32	1.41	1.50	1.58	1.66	1.73	1.80	1.87	1.94	2.00	2.12	2.24
2.5	.042"/1.07mm	0.88	1.08	1.25	1.40	1.53	1.65	1.77	1.88	1.98	2.07	2.17	2.25	2.34	2.42	2.50	2.65	2.80
3	.043"/1.09mm	1.06	1.30	1.50	1.68	1.84	1.98	2.12	2.25	2.37	2.49	2.60	2.70	2.81	2.90	3.00	3.18	3.35
3.5	.048"/1.22mm	1.24	1.52	1.75	1.96	2.14	2.32	2.47	2.63	2.77	2.90	3.03	3.15	3.27	3.39	3.50	3.71	3.91
4	.052"/1.32mm	1.41	1.73	2.00	2.24	2.45	2.65	2.83	3.00	3.16	3.32	3.46	3.61	3.74	3.87	4.00	4.24	4.47
4.5	.055"/1.40mm	1.59	1.95	2.25	2.52	2.76	2.98	3.18	3.38	3.56	3.73	3.90	4.06	4.21	4.36	4.50	4.77	5.03
5	.057"/1.45mm	1.77	2.17	2.50	2.80	3.06	3.31	3.54	3.75	3.95	4.15	4.33	4.51	4.68	4.84	5.00	5.30	5.59
5.5	.06"/1.52mm	1.94	2.38	2.75	3.07	3.37	3.64	3.89	4.13	4.35	4.56	4.76	4.96	5.14	5.33	5.50	5.83	6.15
6	.062"/1.57mm	2.12	2.60	3.00	3.35	3.67	3.97	4.24	4.50	4.74	4.97	5.20	5.41	5.61	5.81	6.00	6.36	6.71
6.5	.064"/1.63mm	2.30	2.81	3.25	3.63	3.98	4.30	4.60	4.88	5.14	5.39	5.63	5.86	6.08	6.29	6.50	6.89	7.27
7	.067"/1.70mm	2.47	3.03	3.50	3.91	4.29	4.63	4.95	5.25	5.53	5.80	6.06	6.31	6.55	6.78	7.00	7.42	7.83
7.5	.070"/1.78mm	2.65	3.25	3.75	4.19	4.59	4.96	5.30	5.63	5.93	6.22	6.50	6.76	7.02	7.26	7.50	7.95	8.39
8	.072"/1.83mm	2.83	3.46	4.00	4.47	4.90	5.29	5.66	6.00	6.32	6.63	6.93	7.21	7.48	7.75	8.00	8.49	8.94
8.5	.074"/1.88mm	3.01	3.68	4.25	4.75	5.21	5.62	6.01	6.38	6.72	7.05	7.36	7.66	7.95	8.23	8.50	9.02	9.50
9	.076"/1.93mm	3.18	3.90	4.50	5.03	5.51	5.95	6.36	6.75	7.12	7.46	7.79	8.11	8.42	8.71	9.00	9.55	10.06
9.5	.078"/1.98mm	3.36	4.11	4.75	5.31	5.82	6.28	6.72	7.13	7.51	7.88	8.23	8.56	8.89	9.20	9.50	10.08	10.62
10	.080"/2.03mm	3.54	4.33	5.00	5.59	6.12	6.61	7.07	7.50	7.91	8.29	8.66	9.01	9.35	9.68	10.00	10.61	11.18
11	.083"/2.11mm	3.89	4.76	5.50	6.15	6.74	7.28	7.78	8.25	8.70	9.12	9.53	9.92	10.29	10.65	11.00	11.67	12.30
12	.087"/2.21mm	4.24	5.20	6.00	6.71	7.35	7.94	8.49	9.00	9.49	9.95	10.39	10.82	11.22	11.62	12.00	12.73	13.42
12.5	.089"/2.26mm	4.42	5.41	6.25	6.99	7.65	8.27	8.84	9.38	9.88	10.36	10.83	11.27	11.69	12.10	12.50	13.26	13.98
13	.091"/2.31mm	4.60	5.63	6.50	7.27	7.96	8.60	9.19	9.75	10.28	10.78	11.26	11.72	12.16	12.59	13.00	13.79	14.53
15	.096"/2.44mm	5.30	6.50	7.50	8.39	9.19	9.92	10.61	11.25	11.86	12.44	12.99	13.52	14.03	14.52	15.00	15.91	16.77
20	.109"/2.77mm	7.07	8.66	10.00	11.18	12.25	13.23	14.14	15.00	15.81	16.58	17.32	18.03	18.71	19.36	20.00	21.21	22.36
25	.125"/3.18mm	8.84	10.83	12.50	13.98	15.31	16.54	17.68	18.75	19.76	20.73	21.65	22.53	23.39	24.21	25.00	26.52	27.95
30	.141"/3.58mm	10.61	12.99	15.00	16.77	18.37	19.84	21.21	22.50	23.72	24.87	25.98	27.04	28.06	29.05	30.00	31.82	33.54
40	.156"/3.96mm	14.14	17.32	20.00	22.36	24.49	26.48	28.28	30.00	31.62	33.17	34.64	36.06	37.42	38.73	40.00	42.43	44.72
50	.172"/4.37mm	17.68	21.65	25.00	27.95	30.62	33.07	35.36	37.50	39.53	41.46	43.30	45.07	46.77	48.41	50.00	53.03	55.90
60	.188"/4.78mm	21.21	25.98	30.00	33.54	36.74	39.69	42.43	45.00	47.43	49.75	51.96	54.08	56.12	58.09	60.00	63.64	67.08

**NOZZLE FAN SELECTION**

Select the nozzle degree or spray angle, based on your application. Standard nozzle degrees - 0°, 15°, 25° and 40°. Using the wrong nozzle degree can damage the surface you are cleaning.

**0° - RED**

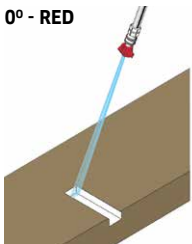

Cutting nozzle, it delivers a concentrated stream that can gouge or cut. It can cut stubborn stains from concrete and other hard surfaces.

**15° - YELLOW**

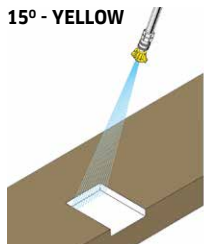

Chiseling nozzle. Working at a 45° angle, this nozzle works like a scraper, stripping paint, grease and grime from hard surfaces.

**25° - GREEN**

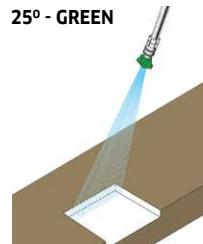

Flushing nozzle. The most commonly used nozzle for cleaning dirt from siding, sidewalks and metal furniture as well as wet sweeping leaves.

**40° - WHITE**

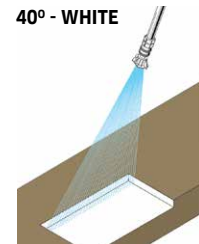

Wash nozzle. Its wide spray allows you to wash and rinse a large area fast. It is usually safe with most surfaces, including aluminum siding, windows and vehicles.



## NOZZLE KITS - LEGACY 4/PK AND 5/PK COLOR-CODED QC

1/4" Quick Coupler Nozzle Kits



- Hardened stainless-steel, one-piece body for long life
- High-impact, uniform, flat-spray pattern
- Color-coded by spray angle
- Includes 40 x 65 soap nozzle



### 4/PK (0°, 25°, 40° AND SOAP)

PART NO.	NOZZLE SIZE	DESCRIPTION
8.726-117.0	3.0	4 pack includes 0°, 25°, 40° and Soap
9.104-028.0	3.25	4 pack includes 0°, 25°, 40° and Soap
8.726-119.0	3.5	4 pack includes 0°, 25°, 40° and Soap
8.726-120.0	4.0	4 pack includes 0°, 25°, 40° and Soap
8.726-121.0	4.5	4 pack includes 0°, 25°, 40° and Soap
8.726-122.0	5.0	4 pack includes 0°, 25°, 40° and Soap
8.726-123.0	5.5	4 pack includes 0°, 25°, 40° and Soap
8.726-124.0	6.0	4 pack includes 0°, 25°, 40° and Soap
8.726-125.0	6.5	4 pack includes 0°, 25°, 40° and Soap

### 5/PK (0°, 15°, 25°, 40° AND SOAP)

PART NO.	NOZZLE SIZE	DESCRIPTION
9.104-024.0	3.0	5 pack includes 0°, 15°, 25°, 40° and Soap
9.104-016.0	3.25	5 pack includes 0°, 15°, 25°, 40° and Soap
8.726-128.0	3.5	5 pack includes 0°, 15°, 25°, 40° and Soap
9.104-030.0	4.0	5 pack includes 0°, 15°, 25°, 40° and Soap
8.726-130.0	4.5	5 pack includes 0°, 15°, 25°, 40° and Soap
8.726-131.0	5.0	5 pack includes 0°, 15°, 25°, 40° and Soap
8.726-132.0	5.5	5 pack includes 0°, 15°, 25°, 40° and Soap
8.726-133.0	6.0	5 pack includes 0°, 15°, 25°, 40° and Soap
8.726-134.0	6.5	5 pack includes 0°, 15°, 25°, 40° and Soap

## NOZZLE KITS - LEGACY 4/PK AND 5/PK COLOR-CODED QC

"QC", Color-coded, hardened stainless nozzle. Fits msot 1/4" quick couplers. Rated for 4000 PSI.

**Legacy**



### QC NOZZLES

ORIFICE	PART NO. 0°	PART NO. 15°	PART NO. 25°	PART NO. 40°
	Red	Yellow	Green	White
3.0	8.723-576.0	8.902-482.0	8.902-484.0	8.902-485.0
3.25	8.708-538.0	8.708-539.0	8.708-540.0	8.708-541.0
3.5	8.723-577.0	8.726-104.0	8.708-526.0	8.902-487.0
3.75	8.708-527.0	8.708-528.0	8.708-529.0	8.708-530.0
4.0	8.708-531.0	8.708-532.0	8.708-533.0	8.708-534.0
4.5	8.723-578.0	8.708-535.0	8.708-536.0	8.708-537.0
5.0	8.726-105.0	8.726-106.0	8.726-107.0	8.726-108.0
5.5	8.723-579.0	8.902-492.0	8.708-542.0	8.902-493.0
6.0	8.726-109.0	8.726-110.0	8.726-111.0	8.726-112.0
6.5	8.726-113.0	8.726-114.0	8.726-115.0	8.726-116.0

### QC SOAP NOZZLES

PART NO.	ORIFICE	DEGREE
8.723-636.0	40	65°

**NOZZLE SETS - 4/PK AND 5/PK COLOR-CODED QC**

Nozzle sets contain a complete set of four quick coupler nozzles at 0°, 15°, 25° and 40°. the 5/PK includes one 40 x 65o soap nozzle.



**4/PK (0°, 15°, 25° AND 40°)**

PART NO.	OLD NO.	NOZZLE SIZE
8.708-712.0	259700	3.5
8.708-713.0	259701	4.0
8.708-714.0	259702	4.5
8.708-715.0	259703	5.0
8.708-716.0	259704	5.5
8.708-717.0	259705	6.0
8.708-718.0	259706	6.5

**5/PK (0°, 15°, 25°, 40° AND SOAP)**

PART NO.	OLD NO.	NOZZLE SIZE
9.104-014.0	259710	3.5
8.708-721.0	259711	4.0
9.104-015.0	259712	4.5
8.708-723.0	259713	5.0
8.708-724.0	259714	5.5
8.708-725.0	259715	6.0
8.708-726.0	259716	6.5

**NOZZLES - GENERAL PUMP**

These quick-coupled, color-coded, hardened stainless nozzles fit most 1/4" quick couplers. Rated for 4000 PSI.



**Q-STYLE NOZZLE**



ORIFICE	PART NO. 0°	OLD NO.	PART NO. 15°	OLD NO.	PART NO. 25°	OLD NO.	PART NO. 40°	OLD NO.
2.0	-	-	8.712-322.0	-	8.708-645.0	-	8.708-652.0	-
2.5	8.708-647.0	-	8.708-648.0	-	8.708-649.0	-	8.708-651.0	-
3.0	9.802-287.0	259610	9.802-288.0	259611	9.802-289.0	259612	8.932-998.0	259613
3.5	9.802-291.0	259615	9.802-292.0	259616	9.802-293.0	259617	9.802-294.0	259618
4.0	9.802-295.0	259620	9.802-296.0	259621	9.802-297.0	259622	9.802-298.0	259623
4.5	9.803-810.0	259625	9.803-811.0	259626	9.803-812.0	259627	9.803-813.0	259628
5.0	9.802-299.0	259630	9.802-300.0	259631	9.802-301.0	259632	9.802-302.0	259633
5.5	9.802-303.0	259635	9.802-304.0	259636	9.802-305.0	259637	9.802-306.0	259638
6.0	9.802-307.0	259640	9.802-308.0	259641	9.802-309.0	259642	9.802-310.0	259643
6.5	8.708-681.0	259645	8.708-682.0	259646	8.708-683.0	259647	8.708-684.0	259648
7.0	9.803-800.0	259650	9.803-801.0	259651	9.803-802.0	259652	9.803-803.0	259653
7.5	8.708-689.0	259655	8.708-690.0	259656	8.708-691.0	259657	8.708-692.0	259658
8.0	8.708-693.0	259660	8.708-694.0	259661	8.708-695.0	259662	8.708-696.0	259663
8.5	8.708-697.0	259665	8.708-698.0	259666	8.708-699.0	259667	8.708-700.0	259668
9.0	8.708-701.0	259670	8.708-702.0	259671	8.708-703.0	259672	8.708-704.0	259673
10.0	8.708-705.0	259675	8.708-706.0	259676	8.708-707.0	259677	8.708-708.0	259678



- 1/4" male pipe thread nozzles, rated up to 5000 PSI. Hardened stainless-steel nozzle insert ensures consistent, accurate orifice size.
- GP M-Style 2.5 x 4.0

ORIFICE	PART NO. 0°	OLD NO.	PART NO. 15°	OLD NO.	PART NO. 25°	OLD NO.	PART NO. 40°	OLD NO.
2.5	-	-	8.708-650.0	-	8.708-569.0	-	8.708-570.0	-
3.0	8.708-572.0	259100	8.708-573.0	259101	8.708-574.0	259102	8.708-575.0	259103
3.5	8.708-576.0	259104	8.708-577.0	259105	8.708-578.0	259106	8.708-579.0	259107
4.0	8.708-580.0	259108	8.708-581.0	259109	8.708-582.0	259110	8.708-583.0	259111
4.5	8.708-584.0	259112	8.708-585.0	259113	8.708-586.0	259114	8.708-587.0	259115
5.0	8.708-588.0	259116	8.708-589.0	259117	8.708-590.0	259118	8.708-591.0	259119
5.5	8.708-592.0	259120	8.708-593.0	259121	8.708-594.0	259122	8.708-595.0	259123
6.0	8.708-596.0	259125	8.708-597.0	259126	8.708-598.0	259127	8.708-599.0	259128
6.5	8.708-600.0	259130	8.708-601.0	259131	8.708-602.0	259132	8.708-603.0	259133
7.0	8.708-604.0	259135	8.708-605.0	259136	8.708-606.0	259137	8.708-607.0	259138
7.5	8.708-608.0	259140	8.708-609.0	259141	8.708-610.0	259142	8.708-611.0	259143
8.0	8.708-612.0	259145	8.708-613.0	259146	8.708-614.0	259147	8.708-615.0	259148
8.5	8.708-616.0	259150	8.708-617.0	259151	8.708-618.0	259152	8.708-619.0	259153
9.0	8.708-620.0	259155	8.708-621.0	259156	8.708-622.0	259157	8.708-623.0	259158
10.0	8.708-624.0	259160	8.708-625.0	259161	8.708-626.0	259162	8.708-627.0	259163

**Q-STYLE CHEMICAL NOZZLE**

- Q-Style chemical nozzles are brass with a large #40 orifice and 65° spray angle. Ideal for low-pressure chemical applications.



**Nozzle Holder Grommet**

PART NO.	OLD NO.	ORIFICE	DEGREE
9.802-311.0	259690	40	65°
8.708-711.0	259695	50	15°

**NOZZLE HOLDER GROMMET**

PART NO.	OLD NO.	DESCRIPTION
8.710-343.0	349917	Grommets - 1/16" x 15/16" x 3/8"

## NOZZLES - SPRAYING SYSTEMS

1/4" male pipe thread meg nozzles, rated up to 4000 PSI. Hardened stainless-steel nozzle ensures consistent, accurate orifice size.



1/4" Male Threads

- PSI: 4000
- Orifice Recessed for Protection
- Flow-Rated Tolerance of  $\pm 2\%$  at 70° F
- Hard-edge pattern, light center requires overlap to cover center

ORIFICE	PART NO. 0°	OLD NO.	PART NO. 15°	OLD NO.	PART NO. 25°	OLD NO.	PART NO. 40°	OLD NO.
2.0	8.707-637.0	251100	8.707-640.0	251105	8.707-643.0	251110	8.707-648.0	251115
2.5	8.707-646.0	251113	8.707-650.0	251116	8.707-653.0	251119	-	-
3.0	8.707-655.0	251120	8.707-657.0	251125	8.707-659.0	251130	8.707-661.0	251135
3.5	8.707-662.0	251140	8.707-664.0	251145	8.707-666.0	251150	8.707-667.0	251155
4.0	8.707-669.0	251160	8.707-671.0	251161	8.707-673.0	251165	8.707-675.0	251170
4.5	8.707-678.0	251175	8.707-679.0	251180	8.707-680.0	251185	8.707-681.0	251190
5.0	8.707-683.0	251195	8.707-686.0	251200	8.707-688.0	251205	8.707-691.0	251210
5.5	8.707-694.0	251215	8.707-695.0	251220	8.707-697.0	251225	8.707-698.0	251230
6.0	8.707-700.0	251235	8.707-702.0	251240	8.707-703.0	251245	8.707-705.0	251250
6.5	8.707-708.0	251255	8.707-710.0	251260	8.707-711.0	251265	8.707-712.0	251270
7.0	8.707-713.0	251275	8.707-715.0	251280	8.707-716.0	251285	8.707-717.0	251290
7.5	8.707-718.0	251300	8.707-719.0	251305	8.707-721.0	251310	8.707-722.0	251315
8.0	8.707-723.0	251320	8.707-726.0	251325	8.707-727.0	251330	8.707-729.0	251335
8.5	8.707-734.0	251340	8.707-735.0	251345	8.707-736.0	251350	8.707-738.0	251355
9.0	8.707-739.0	251360	8.707-741.0	251365	8.707-743.0	251370	8.707-746.0	251375
10.0	8.707-747.0	251380	8.707-751.0	251385	8.707-754.0	251390	8.707-756.0	251395
11.0	8.707-760.0	251400	8.707-761.0	251405	8.707-762.0	251410	8.707-763.0	251415
12.0	8.707-764.0	251420	8.707-766.0	251425	8.707-767.0	251430	8.707-768.0	251435
12.5	8.707-769.0	251440	8.707-770.0	251445	8.707-771.0	251450	8.707-772.0	251455
13.0	8.707-773.0	251460	8.707-774.0	251465	8.707-776.0	251470	8.707-778.0	251475
15.0	8.707-782.0	251480	8.707-787.0	251485	8.707-789.0	251490	8.707-790.0	251495
20.0	8.707-795.0	251500	8.707-800.0	251505	8.707-802.0	251510	8.707-804.0	251515
25.0	8.707-807.0	251520	8.707-811.0	251525	8.707-812.0	251530	8.707-813.0	251535
30.0	8.707-814.0	251540	8.707-817.0	251545	8.707-818.0	251550	8.707-819.0	251555
40.0	8.707-821.0	251560	8.707-824.0	251565	8.707-826.0	251570	8.707-827.0	251575
50.0	8.707-828.0	251580	8.707-830.0	251585	8.707-832.0	251590	8.707-833.0	251595
60.0	8.707-834.0	251600	8.707-835.0	251605	8.707-837.0	251610	8.707-838.0	251615

1/8" male pipe thread meg nozzles, rated up to 4000 PSI. Hardened stainless-steel nozzle ensures consistent, accurate orifice size.



1/8" Male Threads

- PSI: 4000
- Orifice Recessed for Protection
- Flow-Rated Tolerance of  $\pm 2\%$  at 70° F
- Hard-edge pattern, light center requires overlap to cover center

ORIFICE	PART NO. 0°	OLD NO.	PART NO. 15°	OLD NO.	PART NO. 25°	OLD NO.	PART NO. 40°	OLD NO.
2.0	8.707-529.0	250100	8.707-536.0	250105	8.707-537.0	250110	8.707-538.0	250115
2.5	-	-	-	-	8.711-465.0	-	-	-
3.0	8.707-540.0	250120	8.707-542.0	250125	8.707-543.0	250130	8.707-544.0	250135
3.5	-	-	8.707-545.0	250137	8.707-546.0	250138	-	-
4.0	8.707-547.0	250140	8.707-549.0	250145	8.707-550.0	250150	8.707-551.0	250155
4.5	8.707-552.0	250160	8.707-554.0	250165	8.707-556.0	250170	8.707-557.0	250175
5.0	8.707-558.0	250180	8.707-559.0	250185	8.707-561.0	250190	8.707-564.0	250195
5.5	8.707-567.0	250200	8.707-568.0	250205	8.707-569.0	250210	8.707-570.0	250215
6.0	8.707-571.0	250220	8.707-572.0	250225	8.707-573.0	250230	8.707-575.0	250235
6.5	8.707-577.0	250240	8.707-578.0	250245	8.707-579.0	250250	8.707-581.0	250255
7.0	8.707-582.0	250260	8.707-584.0	250265	8.707-585.0	250270	8.707-586.0	250275
7.5	-	250280	-	-	8.707-591.0	250290	8.707-592.0*	250295
8.0	-	-	-	-	-	-	8.707-596.0	250315
8.5	8.707-598.0	250320	-	250325	-	250330	-	250335
9.0	8.707-602.0	250340	8.707-604.0	250345	8.707-605.0	250350	8.707-607.0	250355
9.5	-	-	8.707-609.0	250365	-	-	-	-
10.0	8.707-612.0	250380	8.707-613.0	250385	8.707-614.0	250390	8.707-616.0	250395
11.0	8.707-618.0	250400	8.707-619.0	250405	-	-	-	-
12.0	8.707-621.0	250420	-	-	-	-	8.707-623.0	250435
15.0	8.707-625.0	250440	8.707-626.0	250445	8.707-627.0	250450	-	-

**NOZZLES - SPRAYING SYSTEMS**

"QC" or Quick Connect Hardened Stainless Meg Nozzle, fits most 1/4" quick couplers. Rated for 400 PSI.



- PSI: 4000
- Temperature: 300° F
- Flow-Rated Tolerance of ± 2%
- Hardened Stainless-Steel
- Fits Hansen and Parker Quick-Couplers

**QC "Wash Jet" Nozzle with Color-Coded Nozzle Protector**

ORIFICE	PART NO. 0°	OLD NO.	PART NO. 15°	OLD NO.	PART NO. 25°	OLD NO.	PART NO. 40°	OLD NO.
	Red		Yellow		Green		White	
3.0	8.708-417.0	255120	8.708-418.0	4-12803015S	8.708-419.0	255140	8.708-420.0	4-12803040S
3.5	8.708-422.0	4-12803500S	8.708-423.0	4-12803515S	8.708-424.0	4-12803525S	8.708-425.0	4-12803540S
4.0	8.708-427.0	255160	8.708-428.0	255161	8.708-429.0	255165	8.708-430.0	255170
4.5	8.708-431.0	255175	8.708-432.0	255180	8.708-433.0	255185	8.708-434.0	255190
5.0	8.708-435.0	255195	8.708-436.0	255200	8.708-437.0	255205	8.708-438.0	255210
5.5	8.708-439.0	255215	8.708-440.0	255220	8.708-441.0	255225	8.708-442.0	255230
6.0	8.708-443.0	255235	8.708-444.0	255240	8.708-445.0	255245	8.708-446.0	255250
6.5	8.708-447.0	255255	8.708-448.0	255260	8.708-449.0	255265	8.708-450.0	255270
7.0	8.708-451.0	255275	8.708-452.0	255280	8.708-453.0	255285	8.708-454.0	255290
7.5	8.708-455.0	255300	8.708-456.0	255305	8.708-457.0	255310	8.708-458.0	255315
8.0	8.708-459.0	255320	8.708-460.0	255325	8.708-461.0	255330	8.708-462.0	255335
9.0	-	-	8.708-463.0	255365	8.708-464.0	255370	8.708-465.0	255375
10.0	8.708-467.0	255380	8.708-468.0	255385	8.708-469.0	255390	8.708-470.0	255395
12.0	8.708-471.0	255420	8.708-472.0	255425	-	-	8.708-474.0	255435

**NOZZLES - LOW-PRESSURE APPLICATIONS, BRASS**

1/4" male pipe thread Vee Jet nozzles, brass inexpensive alternative for applications up to 5000 PSI.



**1/4" Male Threads**

- PSI: Up to 5000 PSI
- Feather Edge for Wide Coverage
- Allows Overlap for Even Application
- Excellent for low-pressure chemical and acid applications
- 1/4" MPT Connects

NOZZLE SIZE	PART NO. 0°	OLD NO.	PART NO. 15°	OLD NO.	PART NO. 25°	OLD NO.	PART NO. 40°	OLD NO.	PART NO. 50°	OLD NO.	PART NO. 65°	OLD NO.
15	8.708-203.0	254260B	8.708-204.0	254261B	8.708-206.0	254262B	8.708-208.0	254264B	8.708-210.0	254265B	8.708-212.0	254266B
20	8.708-218.0	254270B	8.708-222.0	254271B	8.708-225.0	254272B	8.708-228.0	254274B	8.708-230.0	254275B	8.708-232.0	254276B
30	8.708-242.0	254290B	8.708-244.0	254291B	8.708-246.0	254292B	8.708-249.0	254294B	8.708-251.0	254295B	8.708-253.0	254296B
40	8.708-258.0	254300B	8.708-260.0	254301B	8.708-262.0	254302B	8.708-264.0	254304B	8.708-266.0	254305B	8.708-268.0	254306B
50	8.708-275.0	254310B	8.708-277.0	254311B	8.708-279.0	254312B	8.708-280.0	254314B	8.708-282.0	254315B	8.708-284.0	254316B
60	8.708-289.0	254320B	8.708-290.0	254321B	8.708-292.0	254322B	8.708-294.0	254324B	8.708-296.0	254325B	8.708-297.0	254326B
70	8.708-302.0	254330B	8.708-304.0	254331B	8.708-306.0	254332B	8.708-308.0	254334B	8.708-309.0	254335B	8.708-310.0	254336B

**NOZZLES - BROAD SPRAY STAINLESS-STEEL**

1/4" male pipe thread 303 stainless-steel Vee Jet nozzles, low - to medium-volume up to 500 PSI medium-pressure / special application PSI.



NOZZLE SIZE	ORIFICE DIA	PART NO. 50°	OLD NO.	PART NO. 65°	OLD NO.	PART NO. 80°	OLD NO.	PART NO. 95°	OLD NO.	PART NO. 110°	OLD NO.
1.0	.026	8.708-074.0	254105	8.708-075.0	254106	8.708-076.0	254107	8.708-078.0	254108	8.708-079.0	254109
1.5	.031	8.708-085.0	254115	8.708-086.0	254115	8.708-087.0	254117	8.708-089.0	254118	8.708-090.0	254119
2.0	.036	8.708-095.0	254125	8.708-096.0	254126	8.708-097.0	254127	8.708-099.0	254128	8.708-101.0	254129
3.0	.043	8.708-108.0	254135	8.708-109.0	254136	8.708-110.0	254137	8.708-112.0	254138	8.708-114.0	254139
4.0	.047	8.708-121.0	254145	8.708-122.0	254146	8.708-123.0	254147	8.708-125.0	254148	8.708-127.0	254149
5.0	.053	8.708-133.0	254155	8.708-134.0	254156	8.708-136.0	254157	8.708-138.0	254158	8.708-140.0	254159
6.0	.058	8.708-148.0	254175	8.708-149.0	254176	8.708-151.0	254177	8.708-155.0	254178	8.708-157.0	254179
7.0	.063	-	254195	8.708-163.0	254196	-	254197	-	-	-	-
8.0	.067	8.708-172.0	254215	8.708-173.0	254216	8.708-175.0	254217	8.708-177.0	254218	8.708-179.0	254219

## TIP-JET NOZZLE SYSTEM - TIPS AND COMPONENTS

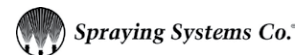

"Tip-Jet" Nozzle Systems are versatile nozzling systems for everyday or specialized applications. Also on page 19. Flat spray, full cone, hollow cone and solid stream patterns, metering orifices and atomizing tips are all available in the Tip-Jet system. Capacities range from .55 to 20 GPM.



Tip-Jet Tips

- PSI: 4000
- Neat and simple tip change
- Hardened stainless-steel tips with vanes for maximum spray integrity
- Strainers Available
- Body components available in brass, zinc-plated steel or stainless-steel

ORIFICE	PART NO. 0°	OLD NO.	PART NO. 15°	OLD NO.	PART NO. 25°	OLD NO.	PART NO. 40°	OLD NO.
3.0	8.708-016.0	253316	-	-	8.708-018.0	253318	-	-
4.0	8.708-019.0	253330	8.708-020.0	253331	8.708-021.0	253332	8.708-022.0	253333
4.5	-	-	8.708-024.0	253339	8.708-025.0	253340	8.708-026.0	253341
5.0	8.708-027.0	253346	8.708-028.0	253348	8.708-029.0	253349	-	-
5.5	8.708-031.0	253355	8.708-032.0	253357	8.708-033.0	253358	8.708-034.0	253359
6.0	8.708-035.0	253365	8.708-036.0	253367	8.708-037.0	253368	8.708-038.0	253369
6.5	-	-	-	-	8.708-040.0	253377	-	-
7.0	8.708-042.0	253383	8.708-043.0	253385	8.708-044.0	253386	8.708-045.0	253387
10.0	8.708-058.0	253456	-	-	-	-	-	-



Tip-Jet Nozzle Bodies, MPT inlet connections in 1/4", 3/8" and 1/2" sizes. All outlet connections are 11/16" - 16 male thread to fit Tip-Jet tip retainers and adapters.



Tip-Jet Nozzle Bodies

PART NO.	OLD NO.	DESCRIPTION	TYPE
8.707-886.0	252511	MPT 1/4"	Nylon
8.707-898.0	252640B	MPT 1/4"	Brass
8.707-899.0	252642	MPT 1/4"	Stainless-steel
8.707-916.0	252861P	MPT 1/4"	Polypropylene



Tip-Jet Adapter Caps

Tip-Jet Adapter Caps, similar to tip retainers, but have FPT connections for in-line applications.

PART NO.	OLD NO.	DESCRIPTION	TYPE
8.707-919.0	252878B	MPT 1/8"	Brass
8.707-921.0	252880B	MPT 1/4"	Brass
8.707-922.0	252881	MPT 1/4"	Stainless-steel



Tip-Jet Retainer Caps

Tip-Jet Retainer Caps, fits all Tip-Jet nozzle bodies, holds spray tips and metering orifices firmly in place.

PART NO.	OLD NO.	DESCRIPTION	TYPE
8.707-915.0	252858B	Hex	Brass
8.707-918.0	252875	Hex	Plated Steel
8.707-888.0	252565	Hex	Stainless-steel



Tip Retainer 18 mm thread, fits vent grip lance. See tip jet nozzles in nozzle section.

PART NO.	OLD NO.	DESCRIPTION
8.710-901.0	373065	Tip Retainer



Tip-Jet Strainers

Tip-Jet Strainers fit into nozzle body cavity to stop nozzle clogging. Brass with stainless-steel mesh.

PART NO.	OLD NO.	DESCRIPTION
8.707-894.0	252627	50-Mesh
8.707-895.0	252629	100-Mesh
8.707-896.0	252631	200-Mesh

## SOFT-EDGE AND HARD-EDGE NOZZLE PROTECTOR

Ideal for protecting sensitive surfaces against damage. Hard plastic body is stable enough to tightly hold nozzle adapter for heavy-duty use.



- Temperature: 300° F
- 1/4" FPT Inlet / Outlet

PART NO.	DESCRIPTION	TYPE
8.723-668.0	ST-10 Nozzle Adapter	Zinc-plated
8.723-669.0	ST-10 Adapter	Stainless-steel

## SOAP NOZZLES

"Black" Soap Nozzles are brass with a large #40 orifice. Ideal for low-pressure chemical applications.



PART NO.	OLD NO.	SIZE	NOZZLE DEGREE
8.708-478.0	255905B	40	25°
8.708-479.0	255920B	40	65°

## ROSEBUD NOZZLE GUARD

Molded rubber guard fits tightly around the nozzle to protect the nozzle and painted surfaces.



PART NO.	OLD NO.	DESCRIPTION
8.710-870.0	373012	Nozzle Guard, 1/8" meg



## NOZZLES

### TURBO NOZZLE THE LEGACY REVOLUTION

**Legacy**

Legacy is proud to offer the Revolution rotary nozzle. This turbo rotary nozzle is rated for up to 4350 PSI at 185° F. Turning at an astounding 4,000 RPM, the Revolution delivers faster and deeper cleaning action for the same price of 3000 PSI rotary nozzles.



- Greater cleaning power: The Revolution is engineered to increase the impact pressure by more than 10 times that of conventional nozzles.
- Longer operating life: The Revolution's operating life is extended significantly by its wear-resistant ceramic nozzle and bearing ring.
- More durable and versatile: The Revolution features an extra-resilient housing protector and is capable of handling a stream up to 4350 PSI at 185° F.

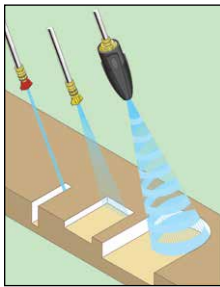

Legacy's Revolution gives you the best of both worlds: the deep cleaning impact of a 0° nozzle and the fast cleaning of a wide-coverage fan spray nozzle.

PART NO.	OLD NO.	ORIFICE	PSI
9.302-242.0	374231	3.5	4350
9.302-243.0	374232	4.0	4350
9.302-244.0	374233	4.5	4350
9.302-245.0	374234	5.0	4350
9.302-246.0	374235	5.5	4350
9.302-247.0	374236	6.5	4350
9.302-248.0	374237	7.0	4350
9.302-249.0	374238	10.0	4350

Repair Kit			
PART NO.	OLD NO.	ORIFICE	PSI
2.884-972.0	079920	3.5	
2.883-824.0	079921	4.0	
9.302-231.0	079922	4.5	
2.883-823.0	079923	5.0	
2.883-822.0	079924	5.5	
9.302-234.0	079925	6.5	
2.884-974.0	079926	7.0	
2.884-975.0	079927	10.0	
2.884-051.0	079928	12.0	

### TURBO NOZZLES

**AP**

AP Revolution Turbo Nozzle is rated for up to 1500 PSI at 212° F. High-impact nozzle at unbelievable pricing!

- Forged Brass
- Precision Ceramic
- Durable Rubber Cover



3000 PSI



4000 PSI



5100 PSI

NOZZLE		REPAIR KIT	
PART NO.	ORIFICE	PART NO.	ORIFICE
3000 PSI		3000 PSI	
8.726-056.0	3.5	-	-
8.726-057.0	4.0	8.726-063.0	4.0
8.726-058.0	4.5	8.726-064.0	4.5
8.726-059.0	5.0	-	-
8.726-060.0	5.5	8.726-066.0	5.5
8.726-061.0	6.0	8.726-067.0	6.0
4000 PSI			
8.726-068.0	3.5	8.726-074.0	3.5
8.726-069.0	4.0	8.726-075.0	4.0
8.726-070.0	4.5	8.726-076.0	4.5
8.726-071.0	5.0	8.726-077.0	5.0
8.726-072.0	5.5	8.726-078.0	5.5
8.726-073.0	6.0	8.726-079.0	6.0
5100 PSI			
8.726-080.0	3.5	8.726-086.0	3.5
8.726-081.0	4.0	8.726-087.0	4.0
8.726-082.0	4.5	-	-
8.726-083.0	5.0	8.726-089.0	5.0
8.726-084.0	5.5	8.726-090.0	5.5
8.726-085.0	6.0	8.726-091.0	6.0

### TURBO A+ NOZZLE KIT



- PSI: 4000
- With 8.726-069.0 Nozzle
- With 8.710-149.0 Inlet Filter

PART NO.	DESCRIPTION	PSI
8.928-444.0	Kit, A+ Turbo Nozzle #4	4000

## ROTOJET 3700 / ROTOJET 5800

0° impact, 25° pattern, no gears - no teeth - no bearings. Exclusive design of the Rotojet 3700 / Rotojet 5800 eliminates start up impact and damage to internal nozzle.



**Rotojet 3700 PSI**

- Temperature: 190° F
- British pipe thread compatible inline filters 8.709-979.0 and 8.709-978.0



**Rotojet 5800 PSI  
(Must Start with Nozzle Down)**

- Temperature: 200° F

- High-Strength, Forged Brass
- Precision Ceramic Orifice and Matching Race

- Durable Rubber / Plastic Cover
- 1/4" BSPP

NOZZLE		
PART NO.	OLD NO.	SIZE
3700 PSI		
8.711-002.0	374130	3.0
8.711-003.0	374131	3.5
8.711-005.0	374134	4.0
8.711-004.0	374132	4.5
8.711-006.0	374135	5.0
8.711-008.0	374137	5.5
8.711-007.0	374136	6.0
5800 PSI		
8.711-009.0	374142	3.0
8.711-010.0	374143	3.5
8.711-011.0	374144	4.0
8.711-012.0	374145	4.5
8.711-013.0	374146	5.0
8.711-014.0	374148	5.5
8.711-015.0	374150	6.0
8.711-016.0	374151	6.5
8.711-017.0	374153	7.0
8.711-018.0	374156	8.0
8.711-019.0	374158	9.0
8.711-020.0	374160	10.0
8.711-023.0	374162	11.0
8.711-021.0	374151	12.0

REPAIR KIT		
PART NO.	OLD NO.	SIZE
3700 PSI		
8.704-039.0	109297	3.0
8.704-038.0	109296	3.5
8.704-040.0	109298	4.0
8.704-041.0	109299	4.5
8.704-042.0	109300	5.0
8.704-043.0	109301	5.5
8.704-044.0	109302	6.0
5800 PSI		
-	-	-
8.704-066.0	109429	3.5
8.704-067.0	109430	4.0
8.704-068.0	109431	4.5
8.704-069.0	109432	5.0
8.704-070.0	109433	5.5
8.704-071.0	109434	6.0
8.704-072.0	109435	6.5
8.704-073.0	109436	7.0
8.704-074.0	109437	8.0
8.704-075.0	109438	9.0
8.704-076.0	109439	10.0
8.704-077.0	109440	11.0
8.704-078.0	109441	12.0

## NOZZLE - TURBO

Provides great impact and cleaning power.



**8.711-098.0**



**8.711-088.0**

NOZZLE		
PART NO.	OLD NO.	SIZE
3650 PSI		
8.711-105.0	374369	3.0
8.711-097.0	374361	3.5
8.711-098.0	374362	4.0
8.711-099.0	374363	4.5
8.711-100.0	374364	5.0
8.711-101.0	374365	5.5
8.711-102.0	374366	6.0
8.711-096.0	374360	6.5
8.711-103.0	374367	7.0
8.711-104.0	374368	8.0
5100 PSI		
8.711-086.0	374350	3.0
8.711-087.0	374351	3.5
8.711-088.0	374352	4.0
8.711-089.0	374353	4.5
8.711-090.0	374354	5.0
8.711-091.0	374355	5.5
8.711-092.0	374356	6.0
8.711-093.0	374357	6.5
8.711-094.0	374358	7.0
8.711-095.0	374359	8.0

REPAIR KIT - TURBO NOZZLES 3650 AND 5100 PSI	
PART NO.	DESCRIPTION
-	-
8.749-913.0	Repair Kit YR51K35
8.749-914.0	Repair Kit YR51K40
8.749-915.0	Repair Kit YR51K45
8.749-916.0	Repair Kit YR51K50
8.749-917.0	Repair Kit YR51K55
-	-
-	-
8.749-920.0	Repair Kit YR51K70
8.749-921.0	Repair Kit YR51K80

NOZZLES - SUTTNER TURBO



ST-357 - 3600 PSI

- Temperature: 190° F
- Forged Brass

- Precision Ceramic Orifice
- Rubber Cover / Protector

**ST-357**

PART NO.	OLD NO.	SIZE	PSI
8.710-986.0	374103	3.0	3600
8.710-987.0	374104	3.5	3600
8.710-989.0	374106	4.0	3600
8.710-988.0	374105	4.5	3600
8.710-991.0	374107	5.0	3600
8.710-993.0	374109	5.5	3600
8.710-992.0	374108	6.0	3600



ST-457 - 6000 PSI

**ST-357 - Repair Kit**

PART NO.	OLD NO.	SIZE	PSI
8.701-570.0	085458	3.0	3600
8.701-569.0	085457	3.5	3600
8.701-564.0	085452	4.0	3600
8.701-562.0	085449	4.5	3600
8.701-565.0	085453	5.0	3600
8.701-568.0	085456	5.5	3600
8.701-566.0	085454	6.0	3600

**ST-457**

PART NO.	OLD NO.	SIZE	PSI
8.711-072.0	374300	3.0	6000
8.711-073.0	374301	3.5	6000
8.711-074.0	374302	4.0	6000
8.711-075.0	374303	4.5	6000
8.711-076.0	374304	5.0	6000
8.711-077.0	374305	5.5	6000
8.711-078.0	374306	6.0	6000
8.711-079.0	374308	7.0	6000
8.711-080.0	374309	8.0	6000
8.711-081.0	374310	10.0	6000

**ST-457 - Repair Kit**

PART NO.	OLD NO.	SIZE	PSI
8.701-572.0	085465A	3.0	6000
8.701-571.0	085465	3.5	6000
8.701-573.0	085466	4.0	6000
8.701-574.0	085467	4.5	6000
8.701-575.0	085468	5.0	6000
8.701-576.0	085469	5.5	6000
8.701-577.0	085470	6.0	6000
8.701-578.0	085472	7.0	6000
8.701-579.0	085473	8.0	6000
8.701-580.0	085474	10.0	6000

### NOZZLE - DIRT KILLER ROTATING

4700 maximum PSI, a popular model providing great impact and leaning power.



8.712-429.0

- Temperature Max: 180° F
- 1/4" Inlet

PART NO.	OLD NO.	ORIFICE	PSI
8.712-429.0	4-20091	045	3200
8.701-160.0	4-200910	Repair Kit	
8.740-148.0	4-20092	055	4700
8.701-161.0	4-200920	Repair Kit	

### ROTOJET SOFT - HARD ROTATING NOZZLE

Offers the cleaning efficiency of a high-pressure rotating nozzle with the feature of changing from a hard spray for concrete to a soft spray for wood by simply pushing or pulling the finger protected nozzle.



8.711-054.0

- PSI: 3600

PART NO.	OLD NO.	ORIFICE	PSI
8.711-053.0	374246	035	3600
8.711-054.0	374247	040	3600
8.711-055.0	374248	045	3600

### MV TRIPLE-FUNCTION NOZZLE

Provides three cleaning options: low-pressure for soap or chemical application; a 15° angle for high-pressure cleaning; and a rotating nozzle for maximum cleaning efficiency.



8.711-068.0

- PSI: 3000

PART NO.	OLD NO.	ORIFICE	PSI
8.711-067.0	374291	035	3000
8.711-068.0	374292	040	3000

### NOZZLE - VIPER ROTATING



- PSI: 5000
- Temperature Max: 190° F
- 1/4" FPT Inlet
- Weight: 1.0 oz



PART NO.	OLD NO.	DESCRIPTION	PSI	STD NOZZLE EQUIV
8.711-000.0	374126	Viper	5000	4.5
8.711-001.0	374127	Viper	5000	5.5
8.701-163.0	080004	Repair Kit	5000	4.5
8.701-166.0	080006	Repair Kit	5000	5.5

### LANCE NOZZLE COUPLERS

Changes MPT lance to FPT for mounting MPT nozzles.



PART NO.	OLD NO.	DESCRIPTION
Brass		
8.705-150.0	140452	1/8" x 1/8"
8.705-155.0	140502	1/4" x 1/8"
8.705-151.0	140454	1/4" x 1/4"
Steel		
8.710-713.0	368903	1/8" x 1/8"
8.710-712.0	368902	1/4" x 1/8"
8.710-714.0	368904	1/4" x 1/4"

### NOZZLE - ROTOMAX ROTATING 3500 AND 5800 PSI



- PSI: Up to 5800 Max
- Temperature Max: 176° F
- 1/4" FPT Inlet
- Weight: 9 oz
- Replaceable Stainless-Steel Orifices

PART NO.	OLD NO.	DESCRIPTION	PSI	STD NOZZLE EQUIV
8.711-035.0	374205	Rotomax I	3500	4.5
8.711-036.0	374210	Rotomax II	3500	5.5
8.711-037.0	374215	Rotomax III	3500	6.5
8.711-038.0	374216	Rotomax 401	5800	4.5
8.711-039.0	374217	Rotomax 403	5800	6.5
8.701-532.0	084400X	Repair Kit		

### NOZZLE - MV HI-LO TURBO



Combines the power of a 0° stream and a 20° wide-angle spray pattern to improve cleaning. Hi-Lo pressure feature eliminates changing to a low-pressure nozzle for soap and chemical applications.



8.711-070.0

PART NO.	OLD NO.	ORIFICE	PSI
8.711-069.0	374294	030	2500
8.711-070.0	374295	035	2500

## NOZZLES

### NOZZLE - ROTOJET 2000

Economy turbo nozzle.



- PSI Max: 2000
- Temperature Max: 140° F
- 1/4" FPT Inlet
- Weight: 5.4 oz
- Great for economy washers

PART NO.	OLD NO.	SIZE	PSI
8.711-026.0	374175	3.0	Yellow
8.711-027.0	374176	3.5	Black

### NOZZLE - DUO-REG

Duo-Reg nozzles are designed for industrial use in ALL applications. Easy push / pull, low-to-high pressure change, and easy-turn to adjust from 0° to 80° fan patter.



- PSI: 3000
- Temperature: 300° F
- 1/4" FPT Connect
- Stainless-Steel Replaceable Orifices
- Tough Glass-Filled Nylon Cover
- Compact Size: 3-3/8" Long, 1-3/16" Diameter
- Weight: 5.7 oz

PART NO.	OLD NO.	COLOR	ORIFICE
8.710-959.0	374030	Yellow	3.0
8.710-960.0	374035	White	3.5
8.710-961.0	374040	Blue	4.0
8.710-962.0	374045	Brown	4.5
8.710-963.0	374050	Green	5.0
8.710-964.0	374055	Sky	5.5
8.710-965.0	374060	Black	6.0
8.710-966.0	374065	Dark Green	6.5

### HIGH-PRESSURE NOZZLE FILTERS

Turbo nozzle protector.



8.709-978.0



8.709-979.0



8.710-150.0



8.710-149.0

- PSI Max: 5000
- Temperature: 300° F

- 1/4" MPT Outlet
- 100-Mesh Screen

PART NO.	OLD NO.	TYPE	INLET	OUTLET
8.709-978.0	342040	Brass	1/4" FPT	1/4" MPT
8.709-979.0	342042	Brass	1/4" QC	1/4" MPT
8.710-149.0	347097	416 SS	1/4" QC	1/4" MPT
8.710-150.0	347098	Brass	1/4" MPT	1/4" MPT
8.704-234.0	110595	Replacement Filter for 342040 / 342042		
8.701-201.0	080115	Replacement Filter for 347097 / 347098		

### NOZZLE - MULTI-FAN

Adjust from maximum Impact Zero Stream to 80° wide-angle spray with a twist of the nozzle body.



- PSI: 2900
- Temperature: 210° F
- 1/4" FPT Connect
- Stainless-Steel Replaceable Orifices
- Stainless-Steel Deflector

PART NO.	OLD NO.	COLOR	ORIFICE
8.710-932.0	373352	Yellow	3.0
8.710-933.0	373353	White	3.5
8.710-934.0	373354	Blue	4.0
8.710-935.0	373356	Brown	4.5
8.710-936.0	373357	Green	5.0
8.710-937.0	373358	Sky	5.5
8.710-939.0	373360	-	6.5
8.710-940.0	373361	-	7.0
8.710-942.0	373363	-	8.0

### INTERCHANGEABLE ORFICE - FITS NOZZLES ABOVE



- Replacement orifices for Duo-Reg and multi-fan nozzles.

PART NO.	OLD NO.	ORIFICE
8.701-448.0	084021	3.0
8.701-452.0	084027	4.5

### ROLLOVER NOZZLE HEAD - ST-56



- PSI Max: 3600
- GPM: 8
- Temperature: 300° F
- 1/4" FPT Inlet and Outlet
- Brass Body
- Glass-Filled Polyimide Cover

PART NO.	OLD NO.	DESCRIPTION	PSI
8.710-895.0	73056	Rollover Nozzle Head	3600



## HL250 HIGH / LOW VARIABLE ANGLE NOZZLE



Push / Pull for easy change between high- and low-pressure; simple twist to adjust 0° - 80° spray fan pattern.



- PSI Max: 4000
- Temperature: 200° F
- 1/4" FPT Inlet
- Weight: .4 lbs
- Glass-Filled Nylon Cover
- Stainless-Steel Replaceable Orifice

PART NO.	OLD NO.	COLOR	ORIFICE
8.710-972.0	374086	Light Green	2.0
8.710-973.0	374087	Pink	2.5
8.710-974.0	374088	White	3.0
8.710-975.0	374090	Brown	3.5
8.710-976.0	374091	Dark Yellow	4.0
8.710-977.0	374092	Blue	4.5
8.710-978.0	374093	Purple	5.0
8.710-979.0	374094	Dark Red	5.5
8.710-980.0	374095	Dark Green	6.0
8.710-982.0	374097	Orange	7.0
8.710-983.0	374098	Silver	8.0

## DOUBLE NOZZLE HEAD



- PSI Max: 3600
- Up to 10 GPM flow for low side pressure, 250 PSI
- Temperature Max: 300° F
- 1/4" Female Inlet, Two Female Outlets
- Heavy Nickel-Plate
- Chemical-Resistant
- Stainless-Steel Ball
- Machined-Brass Body
- New Ball Guide and Seat

PART NO.	OLD NO.	DESCRIPTION	PSI
8.710-897.0	373058A	Double Nozzle Head	3600

## ST-51N ADJUSTABLE NOZZLE



Nozzle holder allows water to be diverted around the fixed orifice nozzle, dropping the pressure and allowing the chemical injector to operate.



- PSI Max: 3600
- Temperature Max: 300° F
- GPM Max: 8.0
- Attaches to 1/4" MPT Lance
- Accepts 1/4" Meg Nozzles
- Weight: 5.9 oz

PART NO.	OLD NO.	DESCRIPTION	PSI
8.710-889.0	373051	ST-51N	3600

## NOZZLE - VARIABLE ANGLE



- PSI: 1450
- Steam Nozzle - 1/4" F
- Steam Blank - 3/8" M
- One-Piece Brass

PART NO.	TYPE	DESCRIPTION	PSI
8.710-971.0	One-piece Brass	Variable Angle Nozzle	1450

Specifications, product descriptions and product availability subject to change without notice.

## ROLLOVER NOZZLE - TWIST-TYPE

Holds two meg nozzles on opposite sides for positive change from chemical application to high-pressure rinse.



- PSI Max: 1000
- Temperature: 180° F
- Nickel-Plated Brass Body

PART NO.	OLD NO.	DESCRIPTION	PSI
8.710-893.0	373054	Dual 1/4" FPT In / Out	1000
8.900-022.0	075020X	Repair Kit	1000

## ADJUSTABLE NOZZLE



Compact, full-feature unit weighs only 4.3 oz, same functions as ST-51N.



- PSI Max: 3600
- Temperature Max: 300° F
- GPM Max: 10
- Machined-Brass Body
- Nylon Adjustment Knob
- 1/4" FPT Inlet / Outlet

PART NO.	OLD NO.	DESCRIPTION	PSI
8.710-891.0	373051P	Adjustable Nozzle	3600

## STEAM NOZZLE



Steam Nozzle Blank



Flat Steam Nozzle

- PSI: 1450
- Steam Nozzle - 1/4" F
- Steam Blank - 3/8" M
- One-Piece Brass

PART NO.	OLD NO.	DESCRIPTION
8.710-958.0	373710	Flat Stream Nozzle, 1.5 mm
8.710-957.0	373702	Steam Nozzle Blank, Drill to Size
8.904-374.0	373705	Nozzle Blank, Drilled to 1.6 mm
8.712-415.0	-	Steam Nozzle, Drilled to 5/64"

## SLIP-ON NOZZLE PROTECTOR



A durable, easy-to-use nozzle protector. Plastic rubber compound - flexible and tough!

- 1-1/2" Diameter at Flare-End
- Slip-Fits Standard Lances
- 2-1/2" Long
- Weight: 1.2 oz
- Slip-On to Lance
- Attach Nozzle Coupler and Nozzle
- Slide protector forward for complete nozzle protection

PART NO.	OLD NO.	DESCRIPTION
8.710-868.0	373006	Slip-on Nozzle Protector

**SEWER / TUBE CLEANING NOZZLES**



The reverse jets on the fixed and rotary nozzles pull the hose through the tube or sewer line and blast debris from line or tube walls.

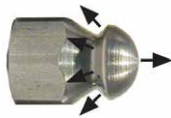

**1-Forward,  
4 Back Ports**

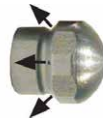

**0-Forward,  
3 Back Ports**



**1-Forward,  
3 Back Ports**

- PSI: 4200
- Physically small for cornering ability
- Corrosion-Resistant Stainless-Steel Construction
- Orifice size indicated on non-rotating styles
- Backwards ports drive the nozzle forward and flush debris
- Rotating style adds extra agitation and surface cleaning

PART NO.	OLD NO.	NOZZLE	ORIFICE	O.D.	PORTS
Non-Rotating Sewer Nozzles					
8.710-875.0	373024	1/8"	4.5	.580"	0-Forward, 3 Back
8.710-874.0	373023	1/8"	5.5	.580"	1-Forward, 3 Back
8.710-878.0	373027	1/4"	4.5	.730"	1-Forward, 3 Back
8.710-876.0	373025	1/4"	5.5	.730"	1-Forward, 3 Back
8.710-877.0	373026	1/4"	6.0	.730"	1-Forward, 4 Back
8.710-880.0	373029	1/4"	7.5	.730"	1-Forward, 4 Back
8.710-879.0	373028	1/4"	8.0	.730"	1-Forward, 3 Back
8.710-881.0	373032	1/4"	12	.730"	1-Forward, 3 Back
8.710-885.0	373038	3/8"	4.0	.920"	1-Forward, 3 Back
8.710-884.0	373037	3/8"	5.5	.920"	1-Forward, 3 Back
8.710-886.0	373039	3/8"	8.5	.920"	1-Forward, 4 Back
8.710-883.0	373036	3/8"	12	.920"	1-Forward, 4 Back
8.710-882.0	373035	3/8"	14	.920"	1-Forward, 4 Back



**0-Forward,  
3 Back Ports**



**0-Forward,  
2 Side Ports**

- PSI: 4000
- Rotating Sewer Nozzle
- Adds Extra Agitation
- Back Jet Only

PART NO.	OLD NO.	NOZZLE	SIZE	PORTS
Rotating Sewer Nozzles				
8.710-899.0	373062	1/8"	5.5	0-Forward, 3 Back
8.710-898.0	373061	1/4"	5.5	0-Forward, 3 Back
8.710-900.0	373064	1/4"	8.0	0-Forward, 3 Back
8.710-887.0	373040	1/4" Duct Cleaner*	5.5	0-Forward, 2 Side

\*Duct Cleaner jet to sides instead of reverse

**LEGACY COMPACT FOAMER**



Generates a high-density clinging foam for extended dwell time to increase chemical action.



- PSI Max: 2500
- Temperature Max: 195° F
- GPM Max: 1-5
- 4 and 6.5 Nozzle Included
- 5" Long, 1" Diameter
- Stainless-Steel, Aluminum and Brass

PART NO.	OLD NO.	DESCRIPTION	PSI
8.903-998.0	344022V	1/8" F Inlet	2500
8.903-999.0	344023V	1/4" F Inlet	2500

Note: Most cleaning chemicals perform best when at 120° - 150° F and can be applied as a foam by adding a foaming agent. See your chemical supplier to obtain the correct products.

**FOAM CANNON**

The ideal foam generator application accessory meters the foaming chemical for customized foam type and applies the foam to match the application.



- PSI Max: 3200
- Temperature Max: 140° F
- GPM Max: 4.8
- Brass Meter Valve
- 1/4" FPT Lance Connect
- High-Impact Glass-Filled Body
- Stainless-Steel 1.5 mm Orifice (#5.5 Nozzle Equivalent)

PART NO.	OLD NO.	DESCRIPTION
8.710-125.0	344030	Foam Cannon / Injector
8.710-126.0	344032	Foam Cannon / Injector / Bottle
8.704-222.0	110311	Replacement Turbulator Screen

**NOZZLE PROTECTOR / COUPLER**



- Protect Nozzles and Finished Surfaces
- Deep Nozzle Recess
- Tough Plastic Protector
- 1/4" FPT Coupler Inlet

PART NO.	OLD NO.	NOZZLE
8.710-866.0	373002	1/8"
8.710-867.0	373004	1/4"

## LEGACY HD PUMPS - THE MOST DURABLE PUMP ON THE MARKET



Legacy is introducing the next wave in high-pressure pumps, the Legacy HD Pump. This heavy-duty, high-pressure pump is the outcome of years of research and development, resulting in a number of upgrades over previous pump models. Premium, long-life components and new design features make the Legacy HD pump a standout among other high-pressure pumps. Tests prove it will hold up better in rugged working conditions.

- Stronger crankcase housing with thicker aluminum cross members and mounting feet for added strength.
- Crankcase features longer overall length to ensure less stress on all parts and a longer life of the pump.
- Super-strong, two-piece connecting rods designed with double-feeder grooves to maximize lubrication for a dramatically cooler running pump.
- Oil level dipstick is vented allowing for heat expansion. Oil level sight glass allows for quick and easy oil inspection.
- Premium European-quality tapered roller bearings on both the drive-side and opposite drive-side of the pump allow for heavier and demanding loads while greatly reducing noise levels and heat build-up.
- Precision machined crankshafts for easy assembly and disassembly. Solid-shaft models have a full 55 mm shaft length to easily accept pulley and sheaves.
- Polished stainless-steel plunger rod reduces friction heat for a smoother and cooler operation.
- High-temperature, long life U-seals correctly fitted for each pump.
- Precision-ground and highly-polished solid ceramic plungers designed and manufactured to withstand dramatic temperature and pressure spikes.
- Dacromet® finish on manifold bolts adds extra rust protection.
- Revolutionary forged-brass heads with exclusive "deep-well-sealing" valve caps eliminate any head pressure effects to the valve cap and valve cap thread.

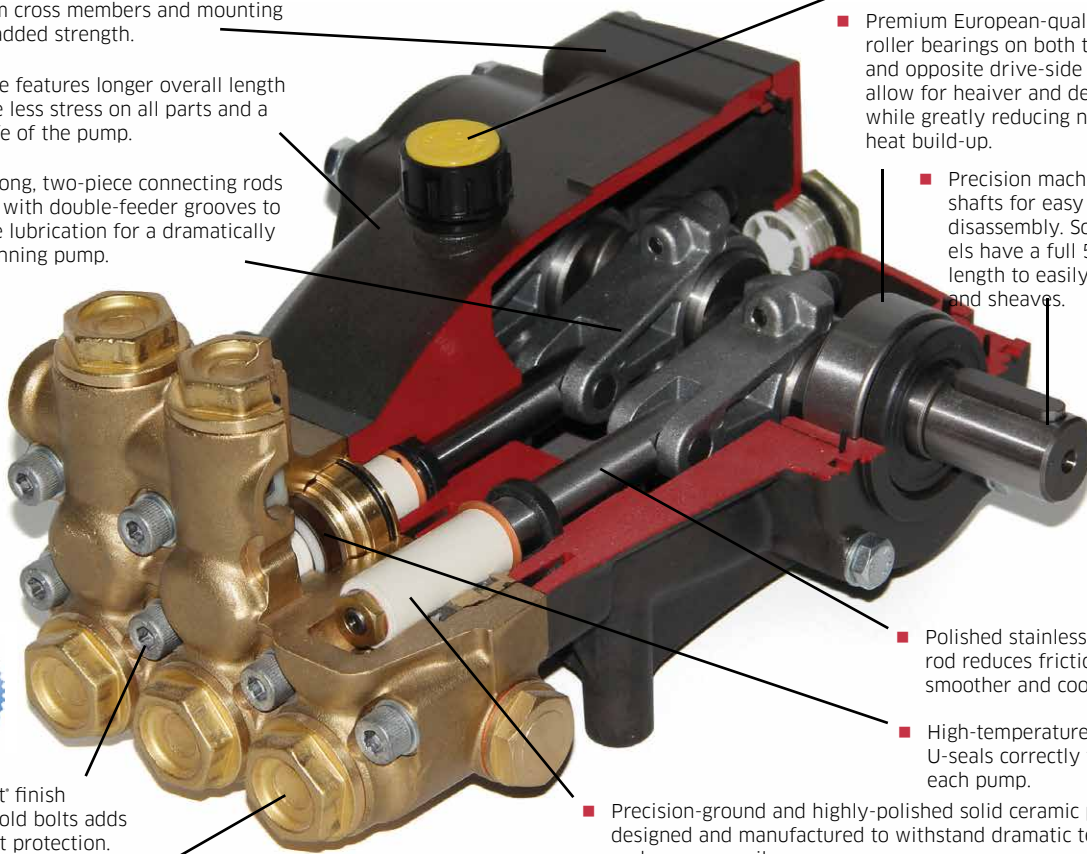

## LEGACY HD PUMPS - THE MOST DURABLE PUMP ON THE MARKET



GX SERIES: 1/2" INLET x 3/8" OUTLET

PART NO.	MODEL NO.	GPM	PSI	HP	RPM	SHAFT	WT (LBS)
8.921-661.0	GX5450R	5.4	5000	17.0	1740	24 mm	39
8.921-662.0	GX5450L	5.4	5000	17.0	1740	24 mm	39
8.920-597.0	GX9536.2R	9.5	3625	23.6	1740	24 mm	38
8.920-598.0	GX9536.2L	9.5	3625	23.6	1740	24 mm	38
8.920-599.0	GX1036.2R	10.4	3625	25.8	1740	24 mm	38
8.920-600.0	GX1036.2L	10.4	3625	25.8	1740	24 mm	38
8.920-602.0	GX1622.2R	15.8	2200	23.8	1740	24 mm	38
8.920-603.0	GX1622.2L	15.8	2200	23.8	1740	24 mm	38
8.752.809.0	GX8043.2	7.9	4350	23.5	1740	24 mm	38

LEGACY PUMPS CONTINUED - BELT DRIVE UNITS

Legacy<sup>HD</sup>



GM SERIES

GM SERIES: 1/2" INLET x 3/8" OUTLET

PART NO.	MODEL NO.	GPM	PSI	HP	RPM	SHAFT	WT (LBS)
8.751-197.0	GM3540R.3	3.5	4000	9.5	1850	24 mm	22
8.751-198.0	GM4030R.3	4	3000	8.2	1000	24 mm	22
8.751-200.0	GM4035R.3	4.8	3500	7.5	1500	24 mm	22
8.751-201.0	GM4035L.3-Left	4.8	3500	7.5	1500	24 mm	22
8.751-202.0	GM5030R.3	5.1	3000	13.5	1550	24 mm	22
8.751-203.0	GM5030L.3	5.1	3000	13.5	1550	24 mm	22
8.751-244.0	GM6035R.3	5.6	3500	13.5	1750	24 mm	22
8.751-245.0	GM6035L.3	5.6	3500	13.5	1750	24 mm	22



GT SERIES

GT SERIES: 1/2" INLET x 3/8" OUTLET

PART NO.	MODEL NO.	GPM	PSI	HP	RPM	SHAFT	WT (LBS)
8.921-722.0	GT4540.2R	4.5	4000	12.3	1360	25 mm	39
8.921-723.0	GT4540.2L	4.5	4000	12.3	1360	25 mm	39
8.921-724.0	GT6036.2R	6.0	3600	14.8	1450	25 mm	39
8.921-725.0	GT6036.2L	6.0	3600	14.8	1450	25 mm	39
8.921-726.0	GT5636.2R	5.6	3600	13.8	1450	24 mm	39
8.921-727.0	GT5636.2L	5.6	3600	13.8	1450	24 mm	39

Legacy<sup>HD</sup>



GB SERIES

GB SERIES: 1/2" INLET x 3/8" OUTLET

PART NO.	MODEL NO.	GPM	PSI	HP	RPM	SHAFT	WT (LBS)
8.923-809.0	GB3030R	3.0	3000	6.2	1650	24 mm	14.5
8.923-810.0	GB3030L	3.0	3000	6.2	1650	24 mm	14.5
8.923-811.0	GB4025R	4.0	2500	6.8	1550	24 mm	14.5
8.923-812.0	GB4025L	4.0	2500	6.8	1550	24 mm	14.5

Legacy



RTG SERIES

READY TO GO SERIES:

- Includes a pump, unloader, thermal protector, bypass loop hose, garden hose inlet with filter and quick coupler.

PART NO.	MODEL NO.	DRIVE	GPM	PSI	RPM	SHAFT	UNLOADER
8.924-458.0	GP3035G	Direct	3.0	3500	3400	3/4"	VRT3
8.924-459.0	GP3535G1	Direct	3.5	3500	3400	1"	VRT3
8.924-460.0	GG54040G.3	Direct	4.0	4000	3400	1"	VRT3
8.924-461.0	GB3030R	Belt	3.0	3000	1650	24 mm	VRT3
8.924-462.0	GM3540R.3	Belt	3.5	4000	1850	24 mm	VRT3
8.924-463.0	GM3840R.3	Belt	3.8	4000	1740	24 mm	VRT3

Legacy

**LEGACY PUMPS - BELT DRIVE UNITS**



HFR SERIES

HFR SERIES: 1-1/4" INLET x 3/4" OUTLET

PART NO.	MODEL NO.	GPM	PSI	HP	RPM	SHAFT DIA	INLET	OUTLET	WT (LBS)
8.751-677.0	HFR40FR	10.6	4100	29.8	1450	40 mm	1"	3/4"	106
8.751-678.0	HFR60FR	15.9	4100	44.7	1450	40 mm	1"	3/4"	106
8.751-680.0	HFR80FL	21.1	4100	59.3	1450	40 mm	1"	3/4"	106
8.751-681.0	HFR80FR	21.1	4100	59.3	1450	40 mm	1"	3/4"	106
8.751-689.0	HFR80SR	21.1	2200	31.8	1000	40 mm	1-1/4"	3/4"	106
8.751-693.0	HFR120SR	31.7	2200	47.8	1000	40 mm	1-1/4"	3/4"	106

**LEGACY PUMPS - BELT DRIVE UNITS**



HHP SERIES

HHP SERIES: 3/4" INLET x 1/2" OUTLET

PART NO.	MODEL NO.	GPM	PSI	HP	RPM	SHAFT DIA	WT (LBS)
8.751-682.0	HHP25SL	6.6	7250	32.8	1000	40 mm	112
8.751-694.0	HHP4150R	10.8	7250	53.6	1450	40 mm	112



NMT SERIES

NMT SERIES: 1/2" INLET x 3/8" OUTLET

PART NO.	MODEL NO.	GPM	PSI	HP	RPM	SHAFT DIA	WT (LBS)
8.754-110.0	NMT1520SCWR	4.8	3000	9.9	1200	24 mm	21
8.755-731.0	NMT2525IS	7.9	3625	19.6	1200	24 mm	41



NMT SERIES

NMT SERIES: 1/2" INLET x 3/8" OUTLET

PART NO.	MODEL NO.	GPM	PSI	HP	RPM	SHAFT DIA	WT (LBS)
8.754-112.0	NLT2525IS	6.6	3000	13.6	1740	24 mm	26





**LEGACY PUMPS - DIRECT DRIVE UNITS**



**GS SERIES**

**GS SERIES: 1/2" INLET x 3/8" OUTLET**

- Direct couple-to-gas engine

PART NO.	MODEL NO.	GPM	PSI	HP	RPM	SHAFT	WT (LBS)
8.751-205.0	GS3040G.3	3.0	4000	9.0	3400	1" Hollow	24.5
8.751-206.0	GS3540G.3	3.5	4000	11.0	3400	1" Hollow	23
8.751-207.0	GS4040G.3	4.0	4000	13.0	3400	1" Hollow	23
8.751-208.0	GS5030G.3	5.0	3000	16.0	3400	1" Hollow	24.5



**GP SERIES**

**GP SERIES: 1/2" INLET x 3/8" OUTLET**

- Direct couple-to-gas engine

PART NO.	MODEL NO.	GPM	PSI	HP	RPM	SHAFT	WT (LBS)
8.923-813.0	GP2535G	2.5	3500	6.0	3400	3/4" Hollow	16.75
8.923-814.0	GP3035G	3.0	3500	7.2	3400	3/4" Hollow	16.75
8.923-815.0	GP3035G1	3.0	3500	7.2	3400	1" Hollow	18
8.923-816.0	GP3535G1	3.5	3500	8.4	3400	1" Hollow	18
8.923-817.0	GP4035G1	4.0	3500	9.6	3400	1" Hollow	18



**GF SERIES**

**GF SERIES: 1/2 - 14 BSPP-F INLET x 3/8-19 BSPP-F OUTLET**

- Direct couple-to-electric motor
- NEMA 56C Frame

PART NO.	MODEL NO.	GPM	PSI	HP	RPM	SHAFT	WT (LBS)
8.923-818.0	GF2030F	2.1	3000	4.3	3450	5/8" Hollow	17
8.923-819.0	GF2030S	2.1	3000	4.3	1725	5/8" Hollow	17
8.923-820.0	GF2830F	2.8	3000	5.8	3450	5/8" Hollow	17
8.923-821.0	GF2830S	2.8	3000	5.8	1725	5/8" Hollow	17
8.923-822.0	GF3530F	3.5	3000	7.2	3450	3/4" Hollow	17



**FOG SERIES**

**FOG SERIES: 3/8 - 19 BSPP-F INLET x 3/8-19 BSPP-F OUTLET**

- Direct couple-to-electric motor
- NEMA 56C Frame

PART NO.	MODEL NO.	GPM	PSI	HP	RPM	SHAFT	WT (LBS)
8.754-501.0	FOG1214R	1.2	1450	1.2	1740	5/8" Hollow	12
8.754-502.0	FOG1914R	1.9	1450	1.9	1740	5/8" Hollow	12
8.754-503.0	FOG2514R	2.5	1450	2.5	1740	5/8" Hollow	12



**HY SERIES**

**HY SERIES: 1/2" INLET x 3/8" OUTLET**

- Direct Couple-to-Electric Motor
- Specifically for Hydraulic Motors

PART NO.	MODEL NO.	GPM	PSI	HP	RPM	SHAFT	WT (LBS)
8.754-984.0	HY1515	4	3000	5.5	1450	5/8" Hollow	16.75
8.754-985.0	HY1520	4	3000	8.2	1450	5/8" Hollow	16.75

**LEGACY PUMPS - BELT DRIVE UNITS**



TML SERIES

**TML SERIES: 1/2" INLET x 3/8" OUTLET**

- Industrial Triplex Plunger pump with AI connecting rods
- 1450 RPM pulley drive with 24 mm solid shaft, 18.9 lbs
- Compare to: General Pumps - the TS series and AR pumps - RK series

PART NO.	OLD NO.	MODEL NO.	GPM	PSI	RPM	SHAFT
8.703-382.0	105924	TML-3053	5.3	3000	1450	24 mm
8.703-457.0	106756	Pump Rail Set (Kit)				

Note: Can be run at 1750 RPM. Please note the pump ships without rails



TTV SERIES

**TTV SERIES: 1/2" INLET x 3/8" OUTLET**

- Heavy industrial Triplex Plunger pump with AI connecting rods
- 1450 RPM pulley drive with 24 mm solid shaft, 18.9 lbs
- Compare to: General Pumps - the TS series and AR pumps - RK series

PART NO.	OLD NO.	MODEL NO.	GPM	PSI	RPM	SHAFT
8.703-387.0	105954	TTV-3555	5.5	3500	1450	24 mm

Note: Can be run at 1750 RPM. Please note the pump ships without rails



KKV SERIES

**KKV SERIES: 1" INLET x 1/2" OUTLET**

- Heavy industrial Triplex Plunger pump with AI connecting rods
- 1450 RPM and 1725 RPM pulley drive with 30 mm solid shaft, 39.6 lbs

PART NO.	OLD NO.	MODEL NO.	GPM	PSI	RPM	SHAFT
8.703-391.0	105962	KKV-3087	8.7	3000	1725	30 mm

Please note the pump ships without rails

**PUMP RAILS**

PART NO.	OLD NO.	DESCRIPTION
8.900-756.0	108762	Heavy Duty Pump Rail - Short (Set)
8.900-757.0	108763	Heavy Duty Pump Rail - Tall (Set)



**LEGACY PUMPS - DIRECT DRIVE UNITS**



WJG SERIES

**WJG SERIES: 3/8" INLET x 3/8" OUTLET**

- Triplex Plunger pump with Bronze connecting rods
- 3450 RPM pulley drive with 3/4" hollow shaft and SAE flange, 13.2 lbs
- Compare to: General Pumps - the TS series and AR pumps - XTV series

PART NO.	OLD NO.	MODEL NO.	GPM	PSI	RPM	SHAFT
8.703-342.0	105812	WJG-2525	2.5	2500	3450	3/4" H



WJH SERIES

**WJH-F SERIES: 3/8" INLET x 3/8" OUTLET**

- Triplex Plunger pump with Bronze connecting rods
- 3450 RPM direct drive with 5/8" hollow shaft and NEMA flange, 13.2 lbs
- Compare to: General Pumps - the TS series and AR pumps - XTV series

**WJH SERIES: 3/8" INLET x 3/8" OUTLET**

- Triplex Plunger pump with AI connecting rods
- 1725 RPM direct drive with 5/8" hollow shaft and NEMA flange, 13.2 lbs
- Compare to: General Pumps - the T and TT series and AR pumps - XTA series

PART NO.	OLD NO.	MODEL NO.	GPM	PSI	RPM	SHAFT
WJH-F						
8.703-346.0	105822	WJH-2525-F	2.5	2500	3450	5/8" H
WJH						
8.703-348.0	105830	WJH-2121	2.1	2100	1725	5/8" H
8.703-349.0	105832	WJH-2132	3.2	2100	1725	5/8" H



**LEGACY PUMPS - BELT DRIVE UNITS**



WGM SERIES

**WGM SERIES: 1/2" INLET x 3/8" OUTLET**

- Premium Triplex Plunger pump with Bronze connecting rods
- 3450 RPM direct drive with 3/4" hollow shaft and SAE flange, 14.7 lbs
- Compare to: General Pumps - the TS series and AR pumps - XMV series

PART NO.	OLD NO.	MODEL NO.	GPM	PSI	RPM	SHAFT
8.703-351.0	105842	WGM-2530	3.0	2500	3450	3/4" H

**LEGACY PUMPS - DIRECT DRIVE UNITS**



WGM 1

**WGM 1" SERIES: 1/2" INLET x 3/8" OUTLET**

- Premium Triplex Plunger pump with Bronze connecting rods
- 3450 RPM direct drive with 1" hollow shaft and SAE flange, 14.7 lbs
- Compare to: General Pumps - the TX series and AR pumps - XMV series

PART NO.	OLD NO.	MODEL NO.	GPM	PSI	RPM	SHAFT
8.703-356.0	105854	WGM-3540	4.0	3500	3450	1" H



TMH

**TMH SERIES: 1/2" INLET x 3/8" OUTLET**

- Industrial Triplex Plunger pump with AI connecting rods
- 1725 RPM direct drive with 1-1/8" hollow shaft and NEMA flange, 18.9 lbs
- Compare to: General Pumps - the EZ series and AR pumps - RKA series
- Temperature Max: 165°F

PART NO.	OLD NO.	MODEL NO.	GPM	PSI	RPM	SHAFT
8.703-375.0	105910	TMH-3035	3.5	3000	1725	1-1/8"
8.703-376.0	105912	TMH-3040	4.0	3000	1725	1-1/8"
8.703-377.0	105914	TMH-3050	5.0	3000	1725	1-1/8"
8.703-378.0	105916	TMH-3055	5.5	3000	1725	1-1/8"



**LEGACY PUMP**

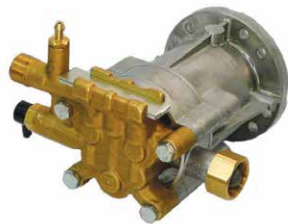

**HORIZONTAL PUMP**

PART NO.	GPM	PSI	RPM	SHAFT
8.920-004.0	2.6	3000	3400	3/4"

Note: Can be used to replace Coment pumps listed on page 75

**VERTICAL PUMP**

PART NO.	GPM	PSI	RPM	SHAFT	DESCRIPTION
8.919-886.0	2.6	3000	3400	7/8"	With Garden Hose Fitting Inlet
9.120-020.0	2.6	3000	3400	7/8"	Without Garden Hose Fitting Inlet

**SEAL KITS**

FOR **Legacy<sup>HD</sup>**



PART NO.	DESCRIPTION
8.725-355.0	U Seal Kit - Packing, 15 mm
8.725-357.0	U Seal Kit - Packing, 18 mm
8.725-359.0	U Seal Kit - Packing, 15 mm
8.725-361.0	U Seal Kit - Packing, 18 mm
8.725-363.0	U Seal Kit - Packing, 20 mm
8.725-365.0	U Seal Kit - Packing, 25 mm
9.804-493.0	U Seal Kit - Packing, 18 mm
8.916-322.0	U Seal Kit - Packing, 20 mm

**PUMP VALVE KITS**

FOR **Legacy<sup>HD</sup>**



PART NO.	DESCRIPTION
9.802-603.0	Pump Valve Complete Kit
9.802-604.0	Pump Valve Complete Kit
9.802-608.0	Pump Valve Complete Kit
9.803-936.0	Pump Valve Complete Kit

**COMPLETE SEAL KITS**

FOR **Legacy<sup>HD</sup>**



PART NO.	DESCRIPTION
8.725-354.0	Complete Seal Kit, 15 mm
8.725-356.0	Complete Seal Kit, 18 mm
8.725-358.0	Complete Seal Kit, 15 mm
8.725-360.0	Complete Seal Kit, 18 mm
8.725-362.0	Complete Seal Kit, 20 mm
8.725-364.0	Complete Seal Kit, 25 mm
8.725-358.0	Complete Seal Kit, 15 mm
9.804-492.0	Complete Seal Kit, 18 mm

**PUMP RAILS**



PART NO.	DESCRIPTION
8.717-577.0	Heavy Duty Pump Rail
9.802-744.0	Mounting Bolts

**PLUNGER OIL SEAL KITS**

FOR **Legacy<sup>HD</sup>**



See chart on pages 59-60

PART NO.	DESCRIPTION
9.802-606.0	Plunger Oil Seal Kit
9.802-609.0	Plunger Oil Seal Kit
9.803-937.0	Plunger Oil Seal Kit

**PLUNGER OIL SEAL KITS**



See chart on pages 59-60

PART NO.	DESCRIPTION
8.754-862.0	Ceramic Plunger Kit, Plunger, 14 mm
8.754-576.0	Ceramic Plunger Kit, Plunger, 15 mm
8.933-023.0	Ceramic Plunger Kit, Plunger, 15 mm
9.803-934.0	Ceramic Plunger Kit, Plunger, 15 mm
8.753-514.0	Ceramic Plunger Kit, Plunger, 16 mm
8.754-858.0	Ceramic Plunger Kit, Plunger, 16 mm
8.754-983.0	Ceramic Plunger Kit, Plunger, 16 mm
8.751-237.0	Ceramic Plunger Kit, Plunger, 18 mm
8.753-823.0	Ceramic Plunger Kit, Plunger, 18 mm
9.802-629.0	Ceramic Plunger Kit, Plunger, 18 mm
9.803-935.0	Ceramic Plunger Kit, Plunger, 18 mm
8.751-238.0	Ceramic Plunger Kit, Plunger, 20 mm
9.802-620.0	Ceramic Plunger Kit, Plunger, 20 mm
8.752-839.0	Ceramic Plunger Kit, Plunger, 22 mm
9.802-614.0	Ceramic Plunger Kit, Plunger, 25 mm
8.752-840.0	Ceramic Plunger Kit, Plunger, 28 mm

**LEGACY PUMP REPAIR KIT SELECTION CHART**



PUMP MODEL SERIES	MM	CHECK VALVE KIT	PLUNGER ROD OIL SEAL KIT	WATER SEAL(S) ONLY KIT	WATER SEALS(S) BRASS RING KIT	VALVE CAP KIT	ACCESSORY SEAL KIT
HDL	18	Kit 93	Kit 37	Kit 95	Kit 96	Kit 94	Kit 98
HG	15	Kit 84	Kit 64	Kit 129	Kit 92	Kit 66	N/A
KKV	22	Kit 40	Kit 37	Kit 90	Kit 87	Kit 132	Kit 98
KKV	25	Kit 40	Kit 37	Kit 91	Kit 88	Kit 100	Kit 98
KTV	20	Kit 123	Kit 37	Kit 89	Kit 86	Kit 99	Kit 98
TMG	15	Kit 123	Kit 65	Kit 74	Kit 69	Kit 67	Kit 78
TMH	18	Kit 123	Kit 65	Kit 76	Kit 71	Kit 67	Kit 78
TML	18	Kit 123	Kit 65	Kit 76	Kit 71	Kit 67	Kit 77
TML-F	15	Kit 123	Kit 65	Kit 74	Kit 69	Kit 67	Kit 77

PUMP MODEL SERIES	MM	CHECK VALVE KIT	PLUNGER ROD OIL SEAL KIT	WATER SEAL(S) ONLY KIT	WATER SEALS(S) BRASS RING KIT	VALVE CAP KIT	ACCESSORY SEAL KIT
TMS	18	Kit 123	Kit 65	Kit 75	Kit 71	Kit 67	Kit 77
TTV	20	Kit 123	Kit 37	Kit 89	Kit 86	Kit 67	Kit 127
WJG	15	Kit 84	Kit 64	Kit 60	Kit 61	Kit 66	Kit 82
WJH-F	15	Kit 84	Kit 64	Kit 60	Kit 61	Kit 66	Kit 82
WJH	18	Kit 84	Kit 64	Kit 12	Kit 10	Kit 66	Kit 82
WMG-3/4"	15	Kit 124	Kit 64	Kit 73	Kit 68	Kit 67	Kit 80
WMG-1"	15	Kit 124	Kit 64	Kit 73	Kit 68	Kit 67	Kit 79
WMH-F	15	Kit 124	Kit 64	Kit 73	Kit 68	Kit 67	Kit 80
WMH	18	Kit 63	Kit 64	Kit 12	Kit 70	Kit 67	Kit 80
WML	18	Kit 63	Kit 64	Kit 12	Kit 70	Kit 67	Kit 81

**LEGACY PUMP REPAIR TOOL KIT**



**9.802-954.0 pump repair tool kit shown.**

PART NO.	DESCRIPTION
9.802-954.0	Legacy Pump Repair Tool Kit (For all models except GB, GP, GP1, GF)
8.756-590.0	Legacy Pump Repair Tool Kit for Normal Maintenance (For models: GB, GP, GP1 and HY)
8.756-717.0	Legacy Pump Repair Tool Kit for Oil Seal Maintenance (For models: GB, GP, GP1 and HY)

PART NO.	DESCRIPTION
9.802-564.0	Guide, Oil Seal Inserter, Plunger Rod GT-GX-GH
9.802-581.0	Piston, Oil Seal Inserter, Plunger Rod GT-GX-GH
9.802-580.0	Piston, Oil Seal Inserter, Plunger Rod GM-GD-GG-GE-GS
9.802-563.0	Guide, Oil Seal Inserter, Plunger Rod GM-GD-GG-GE-GS
9.802-571.0	Wrench, Allen 8 mm, Manifold Bolts GT-GX-GH
9.802-567.0	Wrench, Allen 6 mm, Manifold Bolts GM-GD-GG-GE-GS
9.802-570.0	Wrench, Allen 5 mm, Crankcase Cover
9.802-565.0	Guide, Oil Seal Inserter, Crankshaft GT-GX-GH
9.802-566.0	Guide, Oil Seal Insert, Crankshaft GM-GD-GG-GE-GS
9.802-568.0	Extractor, Piston Seal
9.802-579.0	Piston, Seal Inserter, Manifold GM-GS
9.802-573.0	Guide, Seal Inserter, Manifold GM-GS
9.802-578.0	Piston, Seal Inserter, Manifold GT
9.802-572.0	Guide, Seal Inserter, Manifold GT
8.751-396.0	Guide, Seal Inserter, Manifold GD-GE-GG
8.751-404.0	Guide, Seal Inserter, Manifold GX5050
8.751-397.0	Piston, Seal Inserter, Manifold GD-GE-GG-GH-GX
8.751-405.0	Guide, Seal Inserter, Manifold GH-GX
9.802-569.0	Hammer, Plastic Head
8.751-403.0	Screwdriver Flathead
9.802-574.0	Box, Plastic Tool Box



## LEGACY PUMP REPAIR KITS



PART NO.	OLD NO.	KIT NO.	DESCRIPTION	NO. OF PIECES	QTY NEEDED PER PUMP
8.703-458.0	106810	Kit 10	WJH Packing / Header / Brass Assy, 18 mm	21	1
8.703-459.0	106812	Kit 12	WM - H&L Packing Kit WJH Packing / Header only, 18 mm	15	1
9.803-041.0	106822	Kit 22	APR.S Unloader Seal(s) Kit	14	1
8.703-461.0	106837	Kit 37	TTV-KTV-HDL Plunger Oil Seal Kit	3	1
8.703-462.0	106840	Kit 40	KKV Check Valves / O-ring Kit	12	1
8.932-979.0	106842	Kit 42	APR.S Unloader Valve Seal Kit	3	1
8.900-701.0	106860	Kit 60	V-Packing, 15 mm Legacy Pump WJH, WJH - F&G Packing / Header only, 15 mm	12	1
8.900-702.0	106861	Kit 61	Complete Plunger Set 15 mm 18 PX WJH - F&G Packign / Header / Brass, 15 mm	18	1
8.703-464.0	106863	Kit 63	WMH&L Check Valve / O-ring Kit	12	1
8.703-465.0	106864	Kit 64	HG / WJ / WM Plunger Oil Seal Kit	3	1
8.703-466.0	106865	Kit 65	TM Plunger Oil Seal Kit	3	1
8.703-467.0	106866	Kit 66	HG / WJ Valve Cap / O-ring, M18 x 1.5 Kit	12	1
8.703-468.0	106867	Kit 67	WM / TM / TTV Valve Cap / O-ring, M27 x 1.5	12	1
8.703-469.0	106868	Kit 68	WM - F&G Packing / Brass Assy Kit, 15 mm	21	1
8.703-470.0	106869	Kit 69	TM - F&G Packing / Brass Assy, 15 mm	21	1
8.703-471.0	106870	Kit 70	WM - H&L Packing / Brass Assy Kit, 18 mm	21	1
8.703-472.0	106871	Kit 71	TM - H&L Packing / Brass Assy Kit, 18 mm	24	1
8.703-456.0	106755	Kit 72	WML Pump Rail Kit (Foot, Spacer, Bolt)	8	1
8.703-474.0	106873	Kit 73	WM - F&G Packing only Kit, 15 mm	15	1
8.703-475.0	106874	Kit 74	TM - F&G Packing only Kit, 15 mm	15	1
8.703-476.0	106876	Kit 76	TM - H&L Packing only Kit, 18 mm	18	1
8.703-479.0	106879	Kit 79	WM-G 1" Accessory Seals Kit	8	1
8.703-483.0	106884	Kit 84	HG / WJ Check Valve / O-ring	12	1
8.703-485.0	106886	Kit 86	TTV-KTV Packing / Brass Assy Kit, 20 mm	24	1
8.703-486.0	106887	Kit 87	KKV Packing / Brass Assy Kit, 22 mm	24	1
8.703-488.0	106889	Kit 89	TTV-KTV Packing only Kit, 20 mm	18	1
8.703-489.0	106890	Kit 90	KKV Packing only Kit L90, 22 mm	18	1
8.703-492.0	106893	Kit 93	HDL Check Valve / O-ring	12	1
8.703-493.0	106894	Kit 94	HDL Valve Containment Kit L94	24	1
8.900-703.0	106895	Kit 95	HDL Packing only Kit L90, 18 mm	18	1
8.703-494.0	106896	Kit 96	HDL Packing / Brass Assy Kit, 18 mm	24	1
8.703-498.0	106923	Kit 123	TM-TTV-KTV Check Valve / O-ring Kit	12	1
8.703-499.0	106924	Kit 124	WM - F&G Check Valve / O-ring Kit	12	1
8.703-501.0	106927	Kit 127	TTV Accessory Oil Seal Kit	10	1
8.703-502.0	106929	Kit 129	HG Packing only Kit, 15 mm	12	1

**ADMIRAL PUMP REPAIR KITS**

For the following Admiral pumps: WE Series, XD Series, XLS Series, CA Series, WG Series, XLE Series, XLG Series, C Series, IB Series.

<b>PART NO.</b>	<b>OLD NO.</b>	<b>KIT NO.</b>	<b>DESCRIPTION</b>	<b>QTY NEEDED PER PUMP</b>
8.900-631.0	106501	Kit AP1	Check Valves (For WE, WG, WEL, XL Series, XD Small Brass Head)	1
8.900-632.0	106502	Kit AP2	Brass Valve Covers (For WE, WG, WEL Series and XD Small Brass Head)	1
8.900-633.0	106504	Kit AP4	Oil Seals 15 mm Plunger Rod (For WE, WG and WEL Series)	1
8.900-634.0	106505	Kit AP5	Oil Seals 18 mm Plunger Rod (For XL Series)	1
8.900-636.0	106507	Kit AP7	Male Adapter Rings, 18 mm (For WEL, XLE and XLS Series)	1
8.900-637.0	106508	Kit AP8	V-Packing Seals, 18 mm (For WE and WG Series)	1
8.900-643.0	106514	Kit AP14	Brass Packing Gland, Tow Piece, 18 mm (For XLE and XLS Series)	1
8.900-644.0	106515	Kit AP15	V-Packing Seals, Two Piece, 18 mm (For XLE and XLS Series)	1
8.900-645.0	106516	Kit AP16	Super U-Packing Seals, 18 mm (For XLG Series only)	1
8.900-646.0	106517	Kit AP17	Complete Plunger Seal, Two Piece, 18 mm (For XLE and XLS Series)	3
8.900-647.0	106518	Kit AP18	Complete Plunger Seal, Super-U, 18 mm (For XLG Series only)	3
8.900-648.0	106519	Kit AP19	Brass Packing Gland, Super-U, 18 mm (For XLG Series only)	1
8.900-652.0	106523	Kit AP23	Low Pressure Seals, 18 mm (For XL Series)	1
8.900-653.0	106524	Kit AP24	V-Packing Seals, 15 mm, Two Piece (For WE-T and WG-T Series)	1
8.900-654.0	106525	Kit AP25	V-Packing Seals, 18 mm, Two Piece (For WE-T Series only)	1
8.900-657.0	106528	Kit AP28	Complete Plunger Seal, 15 mm, Two Piece (For WE-T and WG-T Series)	3
8.900-666.0	106538	Kit AP38	"Super U" Packing (For XD 20 mm)	1
8.900-676.0	106552	Kit AP52	Check Valve Assemblies (For IB-1000 Series and CA Series)	1
8.900-680.0	106557	Kit AP57	Male Adapter Rings, 45 mm (For IB-1000 Series C and CA Series)	1
8.900-682.0	106559	Kit AP59	V-Packing Seals, 45 mm (For IB-1000 Series C and CA Series)	1
8.900-683.0	106561	Kit AP61	Glands (45 mm), Brass Packing (For IB-1019, 1032, 1037, C and CA Series)	1

## LEGACY HD PUMP REPAIR KIT SELECTION CHART

FOR **Legacy<sup>HD</sup>**

Use the selection chart below to find the correct repair kits for the specific Legacy HD Pump Model.

PUMP MODEL	SEAL KIT (QTY PER PUMP)	COMPLETE SEAL KIT (QTY PER PUMP)	CERAMIC PLUNGER KIT (QTY PER PUMP)	VALVE KIT (QTY PER PUMP)	PLUNGER OIL SEAL KIT (QTY PER PUMP)
FOG0614R	-	8.754-575.0 (3)		8.754-577.0 (6)	8.754-578.0 (1)
FOG1214R	-	8.754-575.0 (3)		8.754-577.0 (6)	8.754-578.0 (1)
FOG1914R	-	8.754-575.0 (3)		8.754-577.0 (6)	8.754-578.0 (1)
FOG2514R	-	8.754-575.0 (3)		8.754-577.0 (6)	8.754-578.0 (1)
GB3030L	8.754-856.0 (1)	8.754-857.0 (3)	8.754-858.0 (3)	8.754-859.0 (1)	9.803-937.0 (1)
GB3030R	8.754-856.0 (1)	8.754-857.0 (3)	8.754-858.0 (3)	8.754-859.0 (1)	9.803-937.0 (1)
GB4025L	8.754-856.0 (1)	8.754-857.0 (3)	8.754-858.0 (3)	8.754-859.0 (1)	9.803-937.0 (1)
GB4025R	8.754-856.0 (1)	8.754-857.0 (3)	8.754-858.0 (3)	8.754-859.0 (1)	9.803-937.0 (1)
GD3025	8.725-356.0 (1)	8.725-357.0 (3)	9.803-935.0 (3)	9.803-936.0 (1)	9.803-937.0 (1)
GD3030	8.725-354.0 (1)	8.725-355.0 (3)	9.803-934.0 (3)	9.803-936.0 (1)	9.803-937.0 (1)
GD4020.1	8.725-356.0 (1)	8.725-357.0 (3)	9.803-935.0 (3)	9.803-936.0 (1)	9.803-937.0 (1)
GE2020F.1	8.725-354.0 (1)	8.725-355.0 (3)	9.803-934.0 (3)	9.803-936.0 (1)	9.803-937.0 (1)
GE2020S.1	8.725-356.0 (1)	8.725-357.0 (3)	9.803-935.0 (3)	9.803-936.0 (1)	9.803-937.0 (1)
GE2825F.1	8.725-354.0 (1)	8.725-355.0 (3)	9.803-934.0 (3)	9.803-936.0 (1)	9.803-937.0 (1)
GE2825S.1	8.725-356.0 (1)	8.725-357.0 (3)	9.803-935.0 (3)	9.803-936.0 (1)	9.803-937.0 (1)
GE3525F.1	8.725-354.0 (1)	8.725-355.0 (3)	9.803-934.0 (3)	9.803-936.0 (1)	9.803-937.0 (1)
GF2030F	8.754-860.0 (1)	8.725-357.0 (3)	8.754-862.0 (3)	8.754-859.0 (1)	9.803-937.0 (1)
GF2030S	8.754-856.0 (1)	8.725-355.0 (3)	8.754-858.0 (3)	8.754-859.0 (1)	9.803-937.0 (1)
GF2830F	8.754-860.0 (1)	8.754-861.0 (3)	8.754-862.0 (3)	8.754-859.0 (1)	9.803-937.0 (1)
GF2830S	8.754-856.0 (1)	8.754-857.0 (3)	8.754-858.0 (3)	8.754-859.0 (1)	9.803-937.0 (1)
GF3530F	8.754-860.0 (1)	8.754-861.0 (3)	8.754-862.0 (3)	8.754-859.0 (1)	9.803-937.0 (1)
GG2530G.1	8.725-354.0 (1)	8.754-857.0 (3)	9.803-934.0 (3)	9.803-936.0 (1)	9.803-937.0 (1)
GG3030G.1	8.725-354.0 (1)	8.754-861.0 (3)	9.803-934.0 (3)	9.803-936.0 (1)	9.803-937.0 (1)
GG3035G1.1	8.725-354.0 (1)	8.725-355.0 (3)	9.803-934.0 (3)	9.803-936.0 (1)	9.803-937.0 (1)
GG3535G1.1	8.725-354.0 (1)	8.725-355.0 (3)	9.803-934.0 (3)	9.803-936.0 (1)	9.803-937.0 (1)
GG3535G1.1	8.725-354.0 (1)	8.725-355.0 (3)	9.803-934.0 (3)	9.803-936.0 (1)	9.803-937.0 (1)
GG4030G1.1	8.725-354.0 (1)	8.725-355.0 (3)	9.803-934.0 (3)	9.802-604.0 (1)	9.802-606.0 (1)
GH5050	9.804-492.0 (1)	9.804-493.0 (3)	9.802-629.0 (3)	9.802-603.0 (1)	9.802-609.0 (1)
GM3540.2	8.725-358.0 (1)	8.725-359.0 (3)	8.933-023.0 (3)	9.802-603.0 (1)	9.802-609.0 (1)
GM3540.3	8.725-358.0 (1)	8.725-359.0 (3)	8.933-023.0 (3)	9.802-603.0 (1)	9.802-609.0 (1)
GM4030.2	8.725-362.0 (1)	8.725-363.0 (3)	9.802-620.0 (3)	9.802-603.0 (1)	9.802-609.0 (1)
GM4030.2	8.725-362.0 (1)	8.725-363.0 (3)	8.751-238.0 (3)	9.802-603.0 (1)	9.802-609.0 (1)
GM4035.2	8.725-360.0 (1)	8.725-361.0 (3)	9.802-629.0 (3)	9.802-603.0 (1)	9.802-609.0 (1)
GM4035.3	8.725-360.0 (1)	8.725-361.0 (3)	8.751-237.0 (3)	9.802-603.0 (1)	9.802-609.0 (1)
GM5030.2	8.725-362.0 (1)	8.725-363.0 (3)	9.802-620.0 (3)	9.802-603.0 (1)	9.802-609.0 (1)
GM5030.2	8.725-362.0 (1)	8.725-363.0 (3)	8.751-238.0 (3)	9.802-603.0 (1)	9.802-609.0 (1)
GM6035.2	8.725-360.0 (1)	8.725-361.0 (3)	9.802-629.0 (3)	9.802-603.0 (1)	9.802-609.0 (1)
GM6035.3	8.725-360.0 (1)	8.725-361.0 (3)	8.751-237.0 (3)	9.802-603.0 (1)	9.802-609.0 (1)
GP2535G	8.754-860.0 (1)	8.754-861.0 (3)	8.754-862.0 (3)	8.754-859.0 (1)	9.803-937.0 (1)
GP3035G	8.754-860.0 (1)	8.754-861.0 (3)	8.754-862.0 (3)	8.754-859.0 (1)	9.803-937.0 (1)
GP3035G1	8.754-860.0 (1)	8.754-861.0 (3)	8.754-862.0 (3)	8.754-859.0 (1)	9.803-937.0 (1)
GP3535G1	8.754-860.0 (1)	8.754-861.0 (3)	8.754-862.0 (3)	8.754-859.0 (1)	9.803-937.0 (1)
GP4035G1	8.754-860.0 (1)	8.754-861.0 (3)	8.754-862.0 (3)	8.754-859.0 (1)	9.803-937.0 (1)
GS3040G.2	8.725-358.0 (1)	8.725-359.0 (3)	8.933-023.0 (3)	9.802-603.0 (1)	9.802-609.0 (1)
GS3040G.3	8.725-358.0 (1)	8.725-359.0 (3)	8.933-023.0 (3)	9.802-603.0 (1)	9.802-609.0 (1)
GS3540G.2	8.725-358.0 (1)	8.725-359.0 (3)	8.933-023.0 (3)	9.802-603.0 (1)	9.802-609.0 (1)
GS3540G.3	8.725-358.0 (1)	8.725-359.0 (3)	8.933-023.0 (3)	9.802-603.0 (1)	9.802-609.0 (1)
GS4040G.2	8.725-358.0 (1)	8.725-359.0 (3)	8.933-023.0 (3)	9.802-603.0 (1)	9.802-609.0 (1)
GS4040G.3	8.725-358.0 (1)	8.725-359.0 (3)	8.933-023.0 (3)	9.802-603.0 (1)	9.802-609.0 (1)
GS5030G.2	8.725-358.0 (1)	8.725-359.0 (3)	8.933-023.0 (3)	9.802-603.0 (1)	9.802-609.0 (1)

**PUMP VALVE KITS CONTINUED**

FOR **Legacy<sup>HD</sup>**

Use the selection chart below to find the correct repair kits for the specific Legacy HD Pump Model.

<b>PUMP MODEL</b>	<b>SEAL KIT (QTY PER PUMP)</b>	<b>COMPLETE SEAL KIT (QTY PER PUMP)</b>	<b>CERAMIC PLUNGER KIT (QTY PER PUMP)</b>	<b>VALVE KIT (QTY PER PUMP)</b>	<b>PLUNGER OIL SEAL KIT (QTY PER PUMP)</b>
GS5030G.3	8.725-358.0 (1)	8.725-359.0 (3)	8.933-023.0 (3)	9.802-603.0 (1)	9.802-609.0 (1)
GT4540.2L	8.753-821.0 (1)	8.753-822.0 (3)	8.753-823.0 (3)	8.753-824.0 (1)	8.752-835.0 (1)
GT4540.2R	8.753-821.0 (1)	8.753-822.0 (3)	8.753-823.0 (3)	8.753-824.0 (1)	8.752-835.0 (1)
GT5635.1	8.916-488.0 (1)	8.916-322.0 (3)	9.802-607.0 (3)	9.802-603.0 (1)	9.802-606.0 (1)
GT5636.2L	8.753-821.0 (1)	8.753-822.0 (3)	8.753-823.0 (3)	8.753-824.0 (1)	8.752-835.0 (1)
GT5636.2R	8.753-821.0 (1)	8.753-822.0 (3)	8.753-823.0 (3)	8.753-824.0 (1)	8.752-835.0 (1)
GT6036.2L	8.753-821.0 (1)	8.753-822.0 (3)	8.753-823.0 (3)	8.753-824.0 (1)	8.752-835.0 (1)
GT6036.2R	8.753-821.0 (1)	8.753-822.0 (3)	8.753-823.0 (3)	8.753-824.0 (1)	8.752-835.0 (1)
GX1025.1	8.725-364.0 (1)	8.725-365.0 (3)	9.802-614.0 (3)	9.802-608.0 (1)	9.802-606.0 (1)
GX1036.2L	8.752-844.0 (1)	8.752-850.0 (3)	8.752-839.0 (3)	8.752-853.0 (1)	8.752-835.0 (1)
GX1036.2R	8.752-844.0 (1)	8.752-850.0 (3)	8.752-839.0 (3)	8.752-853.0 (1)	8.752-835.0 (1)
GX1622.2L	8.752-845.0 (1)	8.752-851.0 (3)	8.752-840.0 (3)	8.717-589.0 (1)	8.752-835.0 (1)
GX1622.2R	8.752-845.0 (1)	8.752-851.0 (3)	8.752-840.0 (3)	8.717-589.0 (1)	8.752-835.0 (1)
GX5450L	8.753-512.0 (1)	8.753-513.0 (3)	8.753-514.0 (3)	8.753-515.0 (1)	8.752-835.0 (1)
GX5450R	8.753-512.0 (1)	8.753-513.0 (3)	8.753-514.0 (3)	8.753-515.0 (1)	8.752-835.0 (1)
GX8030.1	8.725-364.0 (1)	8.725-365.0 (3)	9.802-614.0 (3)	9.802-608.0 (1)	9.802-606.0 (1)
GX9536.2L	8.752-844.0 (1)	8.752-850.0 (3)	8.752-839.0 (3)	8.752-853.0 (1)	8.752-835.0 (1)
GX9536.2R	8.752-844.0 (1)	8.752-850.0 (3)	8.752-839.0 (3)	8.752-853.0 (1)	8.752-835.0 (1)
HFR105SL	8.754-245.0 (1)	8.754-244.0 (3)	8.754-242.0 (3)	8.754-243.0 (1)	8.754-235.0 (6)
HFR105SR	8.754-245.0 (1)	8.754-244.0 (3)	8.754-242.0 (3)	8.754-243.0 (1)	8.752-235.0 (1)
HFR120SL	8.754-245.0 (1)	8.754-244.0 (3)	8.754-242.0 (3)	8.754-243.0 (1)	8.754-235.0 (1)
HFR120SR	8.754-245.0 (1)	8.754-244.0 (3)	8.754-242.0 (3)	8.754-243.0 (1)	8.754-235.0 (1)
HFR40FL	8.754-231.0 (1)	8.754-232.0 (3)	8.754-233.0 (3)	8.754-243.0 (1)	8.754-235.0 (1)
HFR40FR	8.754-231.0 (1)	8.754-232.0 (3)	8.754-233.0 (3)	8.754-243.0 (1)	8.754-235.0 (1)
HFR40SL	8.754-231.0 (1)	8.754-232.0 (3)	8.754-233.0 (3)	8.754-243.0 (1)	8.754-235.0 (1)
HFR40SR	8.754-231.0 (1)	8.754-232.0 (3)	8.754-233.0 (3)	8.754-243.0 (1)	8.754-235.0 (1)
HFR60FL	8.754-231.0 (1)	8.754-232.0 (3)	8.754-233.0 (3)	8.754-243.0 (1)	8.754-235.0 (1)
HFR60FR	8.754-231.0 (1)	8.754-232.0 (3)	8.754-233.0 (3)	8.754-243.0 (1)	8.754-235.0 (1)
HFR60SL	8.754-231.0 (1)	8.754-232.0 (3)	8.754-233.0 (3)	8.754-243.0 (1)	8.754-235.0 (1)
HFR60SR	8.754-231.0 (1)	8.754-232.0 (3)	8.754-233.0 (3)	8.754-243.0 (1)	8.754-235.0 (1)
HFR80FL	8.754-231.0 (1)	8.754-232.0 (3)	8.754-233.0 (3)	8.754-234.0 (1)	8.754-235.0 (1)
HFR80FR	8.754-231.0 (1)	8.754-232.0 (3)	8.754-233.0 (3)	8.754-234.0 (1)	8.754-235.0 (1)
HFR80SL		8.754-244.0 (3)		8.754-243.0 (1)	8.754-235.0 (1)
HFR80SR		8.754-244.0 (3)		8.754-243.0 (1)	8.754-235.0 (1)
HHP25SL	8.754-236.0 (1)		8.754-246.0 (1)		8.754-235.0 (1)
HHP25SR	8.754-236.0 (1)		8.754-246.0 (1)		8.754-235.0 (1)
HHP2750R	8.754-236.0 (1)	8.754-240.0 (3)	8.754-246.0 (1)	8.754-247.0 (1)	8.754-235.0 (1)
HHP30SL	8.754-236.0 (1)		8.754-246.0 (1)	8.754-241.0 (1)	8.754-235.0 (1)
HHP30SR	8.754-236.0 (1)	8.754-237.0 (3)	8.754-246.0 (1)		8.754-235.0 (1)
HHP3650L	8.754-236.0 (1)	8.754-240.0 (3)	8.754-246.0 (1)	8.754-247.0 (1)	8.754-235.0 (1)
HHP3650R	8.754-236.0 (1)	8.754-240.0 (3)	8.754-246.0 (1)	8.754-247.0 (1)	8.754-235.0 (1)
HHP38FL	8.754-236.0 (1)		8.754-246.0 (1)	8.755-233.0 (1)	8.754-235.0 (1)
HHP38FR	8.754-236.0 (1)		8.754-246.0 (1)	8.755-233.0 (1)	8.754-235.0 (1)
HHP4150L	8.754-236.0 (1)	8.754-240.0 (3)	8.754-246.0 (1)	8.754-247.0 (1)	8.754-235.0 (1)
HHP4150R	8.754-236.0 (1)	8.754-240.0 (3)	8.754-246.0 (1)	8.754-247.0 (1)	8.754-235.0 (1)
HHP5040L	8.754-236.0 (1)	8.754-240.0 (3)	8.754-246.0 (1)	8.754-247.0 (1)	8.754-235.0 (1)
HHP5040R	8.754-236.0 (1)	8.754-240.0 (3)	8.754-246.0 (1)	8.754-247.0 (1)	8.754-235.0 (1)
HHP5750L	8.754-236.0 (1)	8.754-240.0 (3)	8.754-246.0 (1)	8.754-247.0 (1)	8.754-235.0 (1)
HY1515				8.754-577.0 (1)	9.803-937.0 (1)
HY1520				8.754-577.0 (1)	9.803-937.0 (1)
NMT1520CWR	8.754-252.0 (1)	8.754-253.0 (3)	8.754-248.0 (1)	8.754-276.0 (6)	8.754-261.0 (1)
NMT1520SCWR	8.754-252.0 (1)	8.754-253.0 (3)	8.754-248.0 (1)	8.754-276.0 (6)	8.754-261.0 (1)
NMT2120CWR	8.754-252.0 (1)	8.754-253.0 (3)	8.754-248.0 (1)	8.754-276.0 (6)	8.754-261.0 (1)
NMT2120ESR	8.754-239.0 (1)	8.754-229.0 (3)	8.754-256.0 (1)	8.754-230.0 (6)	8.754-261.0 (1)

**INTERPUMP / GENERAL PUMPS**



**8.702-629.0, Solid-Shaft Pumps**



**8.702-635.0**



**8.702-703.0**

**SOLID-SHAFT PUMPS**

PART NO.	MODEL NO.	INTERPUMP	MODEL NO.	GPM	PSI	RPM	SHAFT DIA
8.702-629.0	102048	WS92	TS921	4.75	1800	1450	24 mm
9.802-358.0	102052	W99	T991	3.5	1500	1450	24 mm
8.702-625.0	102046	W92	T921	5.0	1700	1050	24 mm
8.702-622.0	102042	WS82	TS821	5.6	1500	1450	24 mm
8.702-636.0	102058	WS101	TS1011	4.0	2000	1450	24 mm
8.702-635.0	102056	W101	T1011	4.5	2000	1125	24 mm
8.702-646.0	102076	WS133	TS1331	3.5	2100	1450	24 mm
8.702-645.0	102074	WS132	TS1321	4.75	2100	1450	24 mm
8.702-643.0	102072	W132	T1321	5.5	2100	1150	24 mm
8.702-650.0	102084	WS151	TSS1511s	4.0	3500	1450	24 mm
8.702-649.0	102082	W151	T1511	4.5	2500	1125	24 mm
8.702-654.0	102088	W162	T1621	5.0	2500	1050	24 mm
8.702-655.0	102105	W201	T2011	4.5	3000	1125	24 mm
8.702-667.0	102110	WS201	TS2011	4.5	3000	1450	24 mm
8.702-670.0	102115G	WS202	TS2021	5.6	3500	1450	24 mm
8.702-701.0	102170	W995	T9951	3.4	1300	1750	24 mm
8.702-702.0	102174	W996	T9961	4.0	1100	1750	24 mm
8.702-703.0	102176	W997	T9971	4.0	2000	1750	24 mm
8.702-686.0	102135	W912	T9121	4.75	1500	1750	24 mm
8.702-687.0	102140	W913	T9131	4.0	1900	1750	24 mm
8.702-690.0	102150	W921	T9211	4.0	2900	1750	24 mm
8.702-693.0	102152	W928	T9281	4.0	4000	1750	24 mm
8.702-695.0	102154	-T5050	T5050	5.0	5000	1845	24 mm
8.702-661.0	102097	-	TT9111	3.0	1500	1750	24 mm
8.702-630.0	102049	WW93	TT931	2.9	1500	2800	24 mm
8.702-628.0	102047	WW94	TT941	3.43	1300	2800	24 mm
8.702-685.0	102134	WW935	TT9351	3.5	2500	3400	24 mm
8.702-663.0	102102	WW944	TT9441	4.4	2500	3400	24 mm

\*Duplex Pump



**INTERPUMP / GENERAL PUMPS**



**TX SOLID-SHAFT PUMP**

PART NO.	OLD NO.	MODEL NO.	GPM	PSI	RPM	SHAFT DIA
8.702-741.0	102282	TX1510S34	4.0	3000	3400	24 mm

8.702-741.0, TX Solid-Shaft Pumps



**SERIES "44" (EZ SERIES) SOLID-SHAFT PUMPS**

PART NO.	OLD NO.	INTERPUMP MODEL NO.	GP MODEL NO.	GPM	PSI	RPM	SHAFT DIA
8.702-766.0	102313	W956	EZ2536S	3.6	2500	1750	24 mm
8.702-768.0	102317	W959	EZ2542S	4.2	2500	1750	24 mm
8.702-773.0	102320	W186	EZ3040S	4.0	3000	3400	24 mm
8.702-782.0	102333	-	EZ4040S34	4.0	4000	3400	24 mm

Note: For Direct-Drive Mounting of the above pumps. See flanges on page 79

8.702-768.0, Series "44" Solid-Shaft Pumps



**TSF**

PART NO.	OLD NO.	MODEL NO.	GPM	PSI	RPM	SHAFT DIA
8.702-740.0	102281	TSF2021	7.0	3600	1450	24 mm
8.702-736.0	102277	TSF2221	10.2	3000	1750	24 mm
8.702-737.0	102278	TSF2421	12.0	2500	1750	24 mm

8.702-740.0, TSF Pumps



**LARGE FRAME SOLID-SHAFT PUMPS**

PART NO.	OLD NO.	INTER PUMP MODEL NO.	GP MODEL NO.	GPM	PSI	RPM	SHAFT DIA
8.702-612.0	102004	W4A	T41A	12.0	900	650	35 mm
8.702-640.0	102067	WS104	TS1041	8.0	1600	1450	35 mm
8.702-652.0	102086	WS153	TS1531	8.0	2175	1450	35 mm
8.702-648.0*	102079	WS135	TS1351	11.0	2000	1450	35 mm
8.702-657.0*	102092	W163	T1631	10.0	2500	1080	35 mm
8.702-672.0	102120	W203	T2031	9.0	3000	1140	35 mm

\*Double-heated pump

8.702-652.0, Large Frame, Solid-Shaft Pumps



**SOLID-SHAFT CAR WASH PUMPS**

PART NO.	OLD NO.	MODEL NO.	GPM	PSI	RPM	SHAFT DIA	SHIP WT
8.702-754.0	102295	CW2040	5.0	2500	1250	24 mm	30 lbs
8.702-745.0	102286	CW3040	5.0	3000	1250	24 mm	32 lbs
9.107-630.0		HTCK3623S	18.0	1500	1000	30 mm	80 lbs

8.702-754.0, Solid-Shaft Car Wash Pumps

**INTERPUMP / GENERAL PUMPS**



**8.702-711.0, Gas Hollow-Shaft, Direct-Drive Pumps**

**GAS HOLLOW-SHAFT, DIRECT-DRIVE**

PART NO.	OLD NO.	INTER PUMP MODEL NO.	GP MODEL NO.	GPM	PSI	RPM	SHAFT DIA
8.702-711.0	102206	WW906G	TT9061G	2.1	1400	3400	3/4"
8.702-682.0	102130		TT1540GBF	4.0	1500	3400	3/4"
8.702-673.0	102121		TT2028GBF	2.8	2000	3400	3/4"
8.702-674.0	102122		TT2035GBF	3.5	2000	3400	3/4"



**HOLLOW-SHAFT, DIRECT-DRIVE**

- Flanged for direct couple to electric motors

PART NO.	OLD NO.	INTER PUMP MODEL NO.	GP MODEL NO.	GPM	PSI	RPM	SHAFT DIA
8.702-708.0	102202	W905E	T9051E	2.1	1400	1750	5/8"
8.702-710.0	102204	WW906E	TT9061E	2.1	1400	3400	5/8"
8.702-713.0	102210	WW907E	TT9071E	2.8	1500	3400	5/8"
8.702-677.0	102125	-	TT9111EBF	3.0	1500	1750	5/8"
8.702-679.0	102126	-	TT2021EBF	2.1	2000	3400	5/8"
8.702-680.0	102127	-	TT2028EBF	2.8	2000	3400	5/8"
8.702-681.0	102129	-	TT2035EBF	3.5	2000	3400	3/4"



**EZ SERIES HOLLOW-SHAFT, DIRECT-DRIVE**

- Flanged for direct couple to gasoline engines

PART NO.	OLD NO.	INTER PUMP MODEL NO.	GP MODEL NO.	GPM	PSI	RPM	SHAFT DIA
8.702-764.0	102309	WW961EZG	EZ3040G	4.0	2500	3400	1"
8.702-776.0	102324	-	EZ4030G34	3.0	4000	3400	1"
8.702-778.0	102326	-	EZ4035G34	3.5	4000	3400	1"
8.702-779.0	102327	-	EZ4040G34	4.0	4000	3400	1"

**EZ SERIES HOLLOW-SHAFT**

- Flanged for direct couple to electric motors

PART NO.	OLD NO.	INTER PUMP MODEL NO.	GP MODEL NO.	GPM	PSI	RPM	SHAFT DIA
8.702-758.0	102301	W956EZE	EZ2536E	3.6	2500	1750	1-1/8"
8.702-759.0	102303	W959EZE	EZ2542E	4.2	2500	1750	1-1/8"
8.702-761.0	102305	W950EZE	EZ2545E	4.5	2500	3400	1-1/8"
8.702-760.0	102304	W953EZE	EZ2555E	5.5	2500	3400	1-1/8"
8.702-780.0	102330	-	EZ4035E	3.5	4000	3400	1-1/8"



**TX SERIES HOLLOW-SHAFT, DIRECT-DRIVE**

- Flanged for direct couple to 184TC electric motor

PART NO.	OLD NO.	MODEL NO.	GPM	PSI	RPM	SHAFT DIA
8.702-784.0	102335	TX1810E179	3.2	2000	1750	1-1/8"
8.702-785.0	102336	TX1812E179	3.8	2000	1750	1-1/8"

**INTERPUMP / GENERAL PUMP KIT SELECTION CHART**



Use the selection chart below to find the correct repair kit for the specific Interpump / General Pump model.

PUMP MODEL	VALVES	OIL SEAL PISTON	PACKINGS	PACKINGS W/ BRASS	CERAMIC	VALVE CAPS	PISTON	BOLTS HEAD RINGS	CRANK OIL SEAL
TX1510S34	Kit 123	Kit 159	Kit 160	Kit 166	104800	Kit 124	-	-	-
TX1810E179	Kit 123	Kit 159	Kit 161	Kit 167	104804	Kit 124	-	-	-
TX1812E179	Kit 123	Kit 159	Kit 161	Kit 167	104804	Kit 124	-	-	-
TSF2021	Kit 169	Kit 2	Kit 170	Kit 171	083900	-	-	-	Kit 3
TSF2221	Kit 169	Kit 2	Kit 172	Kit 173	107921	-	-	-	Kit 3
TSF2421	Kit 169	Kit 2	Kit 181	Kit 182	107923	-	-	-	Kit 3
T9721	Kit 1	Kit 23	Kit 19	Kit 27	104809	Kit 4	Kit 6	Kit 21	104641
T9731	Kit 1	Kit 23	Kit 19	Kit 27	104809	Kit 4	Kit 6	Kit 21	104637
T731	Kit 1	Kit 23	Kit 19	Kit 27	104809	Kit 4	Kit 6	Kit 21	104641
T991	Kit 1	Kit 23	Kit 19	Kit 27	104809	Kit 4	Kit 6	Kit 21	104641
T9951	Kit 1	Kit 23	Kit 19	Kit 27	104809	Kit 4	Kit 6	Kit 21	104641
T9971	Kit 1	Kit 23	Kit 19	Kit 27	104809	Kit 4	Kit 6	Kit 21	104641
T921	Kit 1	Kit 2	Kit 148	Kit 29	104805	Kit 4	Kit 6	Kit 11	Kit 3
T1011	Kit 1	Kit 2	Kit 69	Kit 28	104803	Kit 4	Kit 6	Kit 7	Kit 3
T1321	Kit 1	Kit 2	Kit 148	Kit 29	104805	Kit 4	Kit 6	Kit 11	Kit 3
T9211	Kit 1	Kit 2	Kit 69	Kit 28	104803	Kit 4	Kit 6	Kit 7	Kit 3
T9281	Kit 1	Kit 2	Kit 109	Kit 112	104808	Kit 106	Kit 107	Kit 108	Kit 3
T4251	Kit 122	Kit 44	Kit 77	Kit 78	104810	-	-	Kit 7	Kit 32
T5050	Kit 150	Kit 2	Kit 109	Kit 151	104808	-	-	Kit 108	Kit 3
TS1021	Kit 1	Kit 2	Kit 69	Kit 28	104803	Kit 4	Kit 6	Kit 7	Kit 3
TS1011	Kit 1	Kit 2	Kit 69	Kit 28	104808	Kit 4	Kit 6	Kit 7	Kit 3
TS1041	Kit 62	Kit 37	Kit 69	Kit 82	104803	-	Kit 54	Kit 7	Kit 32
TS1321	Kit 1	Kit 2	Kit 148	Kit 29	104805	Kit 4	Kit 6	Kit 11	Kit 3
TS1511	Kit 1	Kit 2	Kit 69	Kit 28	104803	Kit 4	Kit 6	Kit 7	Kit 3
TS1531	Kit 62	Kit 37	Kit 69	Kit 82	104803	-	Kit 54	Kit 7	Kit 32
TS2011	Kit 1	Kit 2	Kit 69	Kit 28	104803	Kit 5	Kit 6	Kit 7	Kit 3
TS2021	Kit 1	Kit 2	Kit 69	Kit 28	104803	Kit 5	Kit 6	Kit 7	Kit 3
TT9111	Kit 1	Kit 83	Kit 141	Kit 140	104806	Kit 84	-	-	104641
TT941	Kit 1	Kit 83	Kit 97	Kit 96	083807	Kit 84	-	-	104641
TT9441	Kit 1	Kit 23	Kit 88	Kit 92	104800	Kit 4	-	-	104641
TT2028	Kit 1	Kit 83	Kit 97	Kit 96	083807	Kit 84	-	-	104637
TT2035	Kit 1	Kit 83	Kit 97	Kit 96	083807	Kit 84	-	-	104637
TT9061	Kit 1	Kit 83	Kit 97	Kit 96	083807	Kit 84	-	-	104637
TT9071	Kit 1	Kit 83	Kit 97	Kit 96	083807	Kit 84	-	-	104637
EZ2542E	Kit 123	Kit 23	Kit 127	Kit 131	104804	Kit 124	-	Kit 129	104649
EZ2545E	Kit 123	Kit 23	Kit 88	Kit 130	14800	Kit 124	-	Kit 90	104649
EZ3035G	Kit 123	Kit 23	Kit 88	Kit 130	104800	Kit 124	-	Kit 90	104649
EZ3040G	Kit 123	Kit 23	Kit 88	Kit 130	104800	Kit 124	-	Kit 90	104649
EZ3040S	Kit 123	Kit 23	Kit 88	Kit 130	104800	Kit 124	-	Kit 90	104644
T9051EBF	Kit 1	Kit 83	Kit 97	Kit 96	104800	Kit 84	-	-	104644
EZ2542S	Kit 123	Kit 23	Kit 127	Kit 131	104804	Kit 124	-	Kit 129	104644
EZ3042S	Kit 123	Kit 23	Kit 127	Kit 131	104804	Kit 124	-	Kit 129	104644
ES4040S34	Kit 123	Kit 23	Kit 153	Kit 156	104812	Kit 124	-	Kit 155	104644
EZ3030G34	Kit 123	Kit 23	Kit 88	Kit 130	104800	Kit 124	-	Kit 90	104649
EZ3045G	Kit 123	Kit 23	Kit 88	Kit 130	104800	Kit 124	-	Kit 90	104649
EZ4035G34	Kit 123	Kit 23	Kit 153	Kit 156	104812	Kit 124	-	Kit 155	104649
TS1331-B	Kit 1	Kit 2	Kit 69	Kit 28	104803	Kit 4	Kit 6	Kit 7	Kit 3
T1631	Kit 1	Kit 24	Kit 148	Kit 28	104805	Kit 4	Kit 6	Kit 11	-
CW1012	Kit 62	Kit 37	Kit 113	Kit 67	104813	-	Kit 74	Kit 65	Kit 32

## GENUINE INTERPUMP /GENERAL PUMP KITS



We stock a complete selection of original Interpump / General Pump repair kits. See previous page for our kit selection chart.

■ Complete selection of repair kits

PART NO.	OLD NO.	KIT NO.
8.702-798.0	103001G	Kit 1, Valve
8.702-800.0	103002B	Kit 2, Piston, Rod Oil Seal
8.702-801.0	103003B	Kit 3, Crankshaft Oil Seal
8.702-802.0	103004B	Kit 4, Valve Cap
8.702-803.0	103005B	Kit 5, Valve Cap
8.702-805.0	103006B	Kit 6, Piston Bolt
8.702-806.0	103007B	Kit 7, Head Ring
8.702-116.0	103008B	Kit 8, HP Old Style, 20 mm Packing
8.702-115.0	1-0008	Kit 8, New Style
8.900-442.0	103008LP	Kit 8, Old Style, Packing Kit
8.900-444.0	103009X	Kit 9, Packing Spacer
8.702-809.0	103010B	Kit 10, Retainer, 20 mm Packing
8.702-810.0	103011B	Kit 11, 22 mm Head Ring
8.702-811.0	103012B	Kit 12, 22 mm Packing
8.702-813.0	103015B	Kit 15, Packing Adapter
8.702-814.0	103015B	Kit 16, 24 mm Packing
8.702-817.0	103019B	Kit 19, 20 mm HP Packing
8.702-818.0	103019NB	Kit 19, New Style
8.702-820.0	103020B	Kit 20, 20 mm, Intermed. Ring
8.702-821.0	103021B	Kit 21, 20 mm Head Ring
8.702-823.0	103023B	Kit 23, Piston, Rod Oil Seal
8.702-824.0	103024B	Kit 24, Piston, Rod Oil Seal
8.702-826.0	103027B	Kit 27, 20 mm, Packing Assy
8.702-829.0	103028NB	Kit 28, 20 mm, Packing Assy
8.702-830.0	103029NB	Kit 29, 22 mm, Packing Assy
8.702-833.0	103032B	Kit 32, Crankshaft, Oil Seal
8.702-834.0	103037B	Kit 37, Piston, Rod Oil Seal
8.702-836.0	103038NB	Kit 38, 36 mm Packing

■ See page 75 for our version of these kits for a lower cost alternative

PART NO.	OLD NO.	KIT NO.
8.702-847.0	103058B	Kit 58, K5 Maintenance
8.702-849.0	103060B	Kit 60, K5, Complete Rebuild
8.702-851.0	103062B	Kit 62, Valve
8.702-853.0	103064B	Kit 64, Packing with Intermed. Rings
8.702-854.0	103065B	Kit 65, 30 mm, Head Ring
8.702-856.0	103067B	Kit 67, 30 mm Packing Assy
8.702-857.0	103069NB	Kit 69, 20 mm Packing w/Restop
8.702-858.0	103070B	Kit 70, K7 Maintenance
8.702-859.0	103071B	Kit 71, Intermed Ring w/Restop
8.702-860.0	103072B	Kit 72, Maintenance Kit
8.702-864.0	103077B	Kit 77, 20 mm Packing w/Restop
8.702-872.0	103083B	Kit 83, Oil Seal
8.702-873.0	103084B	Kit 84, Valve Cap
8.702-874.0	103085B	Kit 85, Complete Packing
8.702-875.0	103086B	Kit 86, Packing Retainer
8.702-877.0	103088NB	Kit 88, Packing, EZ3040G
8.702-879.0	103090B	Kit 90, Head Ring
8.702-882.0	103092NB	Kit 92, Piston Seal
8.702-883.0	103093B	Kit 93, Control Set W2
8.702-886.0	103096B	Kit 96, Packing Assy
8.702-887.0	103097B	Kit 97, Packing
8.702-961.0	103220B	Kit 100, Hot Kit, 190° Water (Replaces Kits #1 & #28)

**GENUINE INTERPUMP /GENERAL PUMP KITS CONTINUED**



We stock a complete selection of original Interpump / General Pump repair kits. See previous page for our kit selection chart.

<b>PART NO.</b>	<b>OLD NO.</b>	<b>KIT NO.</b>	<b>PART NO.</b>	<b>OLD NO.</b>	<b>KIT NO.</b>
8.702-893.0	103102B	Kit 102, Unloader Maintenance	8.702-936.0		Kit 156, 13 mm Packing
8.702-897.0	103106B	Kit 106, Valve Cap	8.702-937.0	103159B	Kit 159, Oil Seal
8.702-898.0	103107B	Kit 107, Piston Bolt, Pump T9281	8.702-938.0		Kit 160, Short Packing
8.702-899.0	103108B	Kit 108, Head Ring for T-9281	8.702-939.0	103161B	Kit 161, Packings
8.702-900.0	103109NB	Kit 109, 16 mm, Intermed Ring	9.841-673.0		Kit 163, Seal Retainer
8.702-901.0	103110B	Kit 110, 16 mm, Intermed Ring	9.841-638.0	103165B	Kit 165, Int Ring
8.702-902.0	103111B	Kit 111, Packing, Retainer, 16 mm, Pump T9281	8.702-942.0	103166B	Kit 166, Long Kit 1
8.702-903.0	103112B	Kit 112, 16 mm, Packing Assy	8.702-943.0		Kit 167, Packing Assy
8.702-904.0	103113B	Kit 113, Packing Assy	8.702-945.0	103169B	Kit 169, Valve Kit
8.702-908.0	103118B	Kit 118, Packing	8.702-946.0	103170B	Kit 170, LP Seal Kit and HP Seal
8.702-909.0	103119B	Kit 119, Packing	8.702-947.0	103171B	Kit 171, Packings
8.702-912.0	103122B	Kit 122, Valves	8.702-948.0	103172B	Kit 172, Low / High Packing
8.702-913.0	103123B	Kit 123, Valve, EZ3040	8.702-949.0	103173B	Kit 173, Packings, Kit 176 and Kit 180
8.702-914.0	103124B	Kit 124, Valve Cap and O-Ring for EZ Pump	8.702-952.0		Kit 176, 18 mm Packing
8.702-917.0	103127B	Kit 127, Packing, EZ2542S	8.702-953.0		Kit 180, 18 mm Packing
8.702-919.0	103129B	Kit 129, Head Ring, EZ Series	8.702-954.0	103181B	Kit 181, LP Seal Kit and HP Seal
8.702-920.0	103130B	Kit 130 Packing Complete	8.702-955.0	103182B	Kit 182, Packings, Kit 196 and Kit 197
8.702-921.0	103131B	Kit 131, EZ Pump	8.702-956.0		Kit 196, 15 mm HP Packing
8.702-928.0	103140B	Kit 140, Packing Assy, T9111	8.702-957.0		Kit 197, 18 mm HP Packing
8.702-929.0	103141B	Kit 141, General	8.702-958.0	103201B	Kit 201, Valve kit
8.702-930.0	103148B	Kit 148, 22 mm Packing	8.702-959.0		Kit 202, Packing Kit
8.702-932.0	103150B	Kit 150, Valve, General T5050	8.723-898.0		Kit 203, Seals
8.702-933.0	103151B	Kit 151, Packing Retainer	8.702-960.0		Kit 204, Seals
8.702-934.0	103153B	Kit 153, Packing Kit	8.723-512.0		Kit 212
			8.702-962.0		Kit 226, 15 mm Packing





## AR TRIPLEX CERAMIC PLUNGER PUMPS



8.702-585.0

### DIRECT-DRIVE, GAS ENGINE FLANGED MODELS

PART NO.	OLD NO.	MODEL NO.	GPM	PSI	RPM	SHAFT DIA	WEIGHT (LBS)
8.702-552.0	101804	XTV3G16D-F7	3.0	1600	3400	3/4"	10
8.702-494.0	101701	XTV3G22D-F7	3.0	2200	3400	3/4"	11
8.702-498.0	101711	XMV3G30D-F24	3.0	3000	3400	1"	19
8.702-495.0	101702	XMV3G25D-F25	3.0	2500	3400	3/4"	19
8.702-542.0	101792	XMV35G25D-F25	3.5	2500	3400	3/4"	19
8.702-602.0	101867	RKV4G32D-F24	4.0	3200	3400	1"	21
8.702-582.0	101868	RKVG35HD-F24	4.0	3500	3400	1"	21



8.702-513.0

### SOLID-SHAFT MODELS

PART NO.	OLD NO.	MODEL NO.	GPM	PSI	RPM	SHAFT DIA	WEIGHT (LBS)
8.702-506.0	101731	XTA3G22N	3.0	2200	1750	24 mm	11
8.715-307.0	101780	XMA3.5G25N	3.5	2500	1750	24 mm	18
8.702-593.0	101873	RKA4G30N	4.0	3000	1750	24 mm	19
8.702-597.0	101877	RKA4G40HN	4.0	4000	1750	24 mm	21
8.702-520.0	101765	XW2128N	5.5	4060	1450	24 mm	34
8.702-513.0	101750	XW2623	6.87	3400	1450	24 mm	34



8.702-504.0

### DIRECT-DRIVE ELECTRIC FLANGED MODELS

PART NO.	OLD NO.	MODEL NO.	GPM	PSI	RPM	SHAFT DIA	WEIGHT (LBS)
8.702-504.0	101730	XTA2G15E	2.1	1500	1750	5/8"	9
8.702-550.0	101801	XTV2G15EBA-F8	2.1	1500	3400	5/8"	10
8.702-551.0	101803	XTV3G16E-F8	3.0	1600	3400	5/8"	10
8.702-508.0	101737	XTV3G20E-F8	3.0	2000	3400	5/8"	11
8.702-500.0	101717	XTV3G22E-F8	3.0	2200	3400	5/8"	11
8.702-515.0	101756	XTA3G22E-F8	3.0	2200	1750	5/8"	11
8.702-514.0	101755	XTA3G16EBA-F8	3.0	1600	1750	5/8"	10
8.702-591.0	101871	RKA4G20E-F-17	4.0	2000	1750	1-1/8"	21
8.702-592.0	101872	RKA4G30E-F17	4.0	3000	1750	1-1/8"	21

**AR PUMP REPAIR KIT SELECTION CHART**



Use the following chart to find AR Repair Kits by pump model number. See next page for AR kit part numbers. We also stock a broad selection of non-kit AR repair parts.

PUMP MODEL	WATER SEALS	CHECK VALVES	OIL SEALS	PISTON KIT	PISTON GUIDE	SUPPORT RINGS	HOT KIT
XJV	AR002798	AR001864	AR002797	AR002796	AR1980180 ea	AR1980190 ea	-
XJW	AR002800	AR001864	AR002797	AR002796	AR1980180 ea	AR1980190 ea	-
XT-15MM	AR001866	AR001864	AR001872-N ver AR002725-H/D	AR002628	AR1260151 ea	AR1520120 ea	AR002029-V
XT-18MM	AR001874	AR001864	AR001872-N ver AR002726-H/D	AR002629	AR1260450 ea	AR1320340 ea	AR002030-V
XTA-15MM	AR001866	AR001864	AR001860-E ver	AR002628	AR1260151 ea	AR1520120 ea	AR002029-V
XTA-18MM	AR001874	AR001864	AR001860-E ver	AR002629	AR1260450 ea	AR1320340 ea	AR002030-V
XTV	AR001866	AR001864	AR001860-D, E ver AR001872-N ver	AR002628 AR002725-H/D	AR1260151 ea	AR1520120 ea	AR002029-V
XM-15MM	AR002741	AR001864	AR002786-N ver AR1780100 ea R	AR002544	AR1780090 ea F	AR002740	AR002030-V
XM-18MM	AR002747	AR001864	AR002786-N ver AR1780120 ea R	AR002545	AR1780110 ea F	AR002745	AR002029-V
XMA-15MM	AR002741	AR001864	AR002786-N ver AR1780100 ea R	AR002544	AR1780090 ea F	AR002740	AR02776
XMA-18MM	AR002747	AR001864 AR002787-E ver	AR002786-N ver AR1780120 ea R	AR002545	AR1780110 ea F	AR002745	AR002777
XMV	AR002741	AR001864 AR002787-D ver	AR002786-N ver AR1780100 ea R	AR002544	AR1780090 ea F	AR002740	AR02776
XRC-18MM	AR001857	AR001828	AR001855-N ver	AR002546	AR13800900 ea	AR001829	AR002777
XRC-20MM	AR001887	AR001828	AR001855-N ver	AR002547	AR1380150 ea	AR001815	AR002776
XRCA-18MM	AR001857	AR001828 AR001856-E ver	AR001855-N ver	AR002546	AR13800990 ea	AR001829	AR002809
XRCA-20MM	AR001887	AR001828	AR001855-N ver AR001856-E ver	AR002547	AR1380150 ea	AR001815	AR002810
XRCV	AR001857	AR001828	AR001856-D, E ver	AR002546	AR1380090 ea	AR001829	AR002809
RK-18MM	AR001857	AR002864	AR001855-N ver	AR002547	AR1380090 ea	AR001829	AR002809
RK-20MM	AR001887	AR002864	AR001855-N ver	AR002546	AR1380150 ea	AR001815	AR002810
RKA-18MM	AR001857	AR002864	AR001855-N	AR002546	AR1380090 ea	AR001829	AR002809
RKA-20MM	AR001887	AR002864	AR001855-N ver	AR002547	AR1380090 ea	AR001515	AR002810
RKV	AR001857	AR001828	AR001856	AR002546	AR1380150 ea	AR001829	AR002809
XW-20MM	AR002782	AR002780	AR002781	AR002650	AR1380090 ea	-	AR002778
XW-22MM	AR002783	AR002780	AR002781	AR001891	AR002785	-	AR002779
XWA-20MM	AR002782	AR002780	AR002781	AR002650	AR002784	-	AR002778
XWA-22MM	AR002783	AR002780	AR002781	AR001891	AR002785	-	AR002779
SXW-18MM	AR002874	AR002871	AR002873	AR002548	AR002875	-	-

## AR PUMP KITS



Original factory-direct repair kits. See previous page for kit selection chart. Don't see what you're looking for? Give us a call. We stock a broad selection of AR replacement parts. AR piston kits contain all that you need to repair broken pistons, O-rings, washers, nuts, plungers...YOU GET IT ALL!



PART NO.	OLD NO.	KIT DESCRIPTION	PART NO.	OLD NO.	KIT DESCRIPTION
8.720-573.0	AR001804	Packing	8.720-606.0	AR001887	Water Seals
8.720-574.0	AR001805	Packing, 20 mm	8.720-611.0	AR002031	Viton Seal, XRA
8.740-118.0	AR001806	Pump	8.720-612.0	AR002043	Oil Seal
8.720-575.0	AR001815	Piston	8.720-613.0	AR002044	Seal
8.720-578.0	AR001825	Valve Kit	8.720-632.0	AR002544	Piston, XM*
8.720-579.0	AR001826	Piston Bolt	8.720-633.0	AR002546	Piston XRCA / XRCV
8.720-581.0	AR001828	Valve	8.720-643.0	AR002624	Seal
8.720-582.0	AR001829	Ring, Support, XRA / XRV*	8.720-644.0	AR002628	AR Piston #2628
8.720-583.0	AR001830	Repair, AR 2882, O-Rings Only	8.720-649.0	AR002697	Repair, Combination Set
8.720-585.0	AR001842	Piston, XRA / XRV*	8.720-651.0	AR002740	Support Ring, XM*
8.720-586.0	AR001843	Piston, XRA, XR	8.720-652.0	AR002741	Water Seal, XM*
8.720-592.0	AR001855	Oil Seal, XRA*	8.720-655.0	AR002747	Packing, XMA* 18 mm
8.720-593.0	AR001856	Oil Seal, XRV	8.720-658.0	AR002776	Hot / Dry Cup
8.720-594.0	AR001857	Packing, XRA / XRV*	8.720-661.0	AR002780	Valve, XWA8G30N-SX
8.720-596.0	AR001860	Seal, Oil, XTV*	8.720-662.0	AR002781	Seal, XWA8G30N-SX
8.720-597.0	AR001864	Valve Kit	8.720-663.0	AR002782	Piston Seal, XWA8G30N-SX
8.720-598.0	AR001865	Oil Seal	8.720-665.0	AR002784	Piston Guide, XWA8G30N-SX
8.720-599.0	AR001866	Water Seals	8.720-667.0	AR002786	Oil Seals, XMA35G25N
8.720-601.0	AR001869	Repair Unloader	8.720-668.0	AR002787	Oil Seals
8.720-602.0	AR001872	Oil Seal	8.720-684.0	AR002864	Valve Kit, RK*
8.720-603.0	AR001873	Oil Seal Kit Complete			
8.720-604.0	AR001874	Packing			

\*Series

## COMET PUMPS AND PUMP KITS



For use in homeowner or light commercial-duty pressure washer.

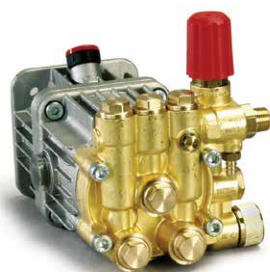

- One-Piece Bronze Connection Rods
- Built-in Unloader
- Increased surface area for lower operating temperatures Ultra High-Pressure Head

PART NO.	OLD NO.	MODEL NO.	GPM	PSI	RPM	SHAFT DIA
9.802-357.0	5-2107	AXD 2020 E	1.9	2000	3400	5/8" Hollow
8.702-576.0	101850	AXD 3020 G	2.75	2000	3400	3/4" Shaft, Belt Drive
8.715-286.0	830160	AXD 2427 G	2.5	2700	3400	3/4" Hollow
8.750-238.0		BXD 2020 E	1.9	2000	3400	5/8" Hollow

Comet kits and parts are available for any Comet model. Call with model number for quick and accurate service.



PART NO.	OLD NO.	MODEL NO.
8.721-902.0	CT0202002000	Piston, 15 mm, FWD
8.721-903.0	CT0202002200	Piston, 18 mm, FWD
8.718-556.0	CT5019003500	Seal Kit, LW, HP
8.721-979.0	CT5019003800	Packing Kit, FWS / FWD
8.721-985.0	CT5019004500	Seal Kit Oil, LW Series, Hollow
8.721-986.0	CT5019006400	Seal Kit, ZWD4030G
8.721-987.0	CT5019006500	Seal Kit, Hollow Shaft Pumps
8.721-989.0	CT5019007800	Seal Kit, AXD2020
8.721-988.0	CT5019007700	Seal Kit, AXD3020
8.750-711.0		Seal Kit, BXD2020 E
8.721-996.0	CT502500100	Valve Kit ZWD / FWS / FWD / HW / FW / LW
8.721-997.0	CT5025001400	Valve Kit, AXD 3020
8.725-562.0		Valve Kit, BXD 2020

**CERAMIC PLUNGERS**



- Precision-ground, high-polish, solid ceramic plungers, designed for long life even under constant use.

PART NO.	OLD NO.	GENERAL PUMP PART NO.	SIZE
8.703-185.0	104798	51040109	18 mm
8.703-187.0	104800	52040009	15 mm, EZ Series
8.703-188.0	104801	46040009	For W50 Pump
8.703-190.0	104803	47040409	20 mm
8.703-191.0	104804	44040109	18 mm, EZ Series
8.703-192.0	104805	47040509	22 mm
8.900-575.0	104806	51040166	18 mm, TP Series
8.703-193.0	104807	47040609	24 mm Solid, Ceramic
8.703-194.0	104808	47040856	16 mm, 47 Series
8.703-195.0	104809	50040409	20 mm, T Series 49
8.703-196.0	104810	61040056	20 mm, 76 & 77 Series
8.703-198.0	104812	44040266	13 mm, EZ Series
8.703-200.0	104815	76040209	45 mm
8.703-767.0	107921	66040109	22 mm, TSF2221
8.703-768.0	107923	66040409	24 mm
8.701-400.0			15 mm, T21

**PACKING AND SEAL KITS**



UPC, General Pump and Interpump replacement kits. Time-tested, quality parts meet or exceed factory specifications.



PART NO.	OLD NO.	DESCRIPTION
8.900-438.0	103001X	Kit 1, Check Valve
8.900-440.0	103002X	Kit 2, Oil Seal
8.900-441.0	103003X	Kit 3, Cranshaft Oil Seal
8.900-442.0	103008LPX	Kit 8, New Style Packing Kit
8.900-443.0*	103008X	Kit 8, V-Packing
8.900-444.0*	103009X	Kit 9, Intermed Packing
8.900-447.0*	103012X	Kit 12, V-Packing
8.900-456.0*	103019X	Kit 19, V-Packing
8.900-463.0	103023X	Kit 23, Crankcase Oil Seal
8.900-464.0	103024X	Kit 24, Crankcase Oil Seal
8.900-466.0*	103027X	Kit 27, Plunger Repair
8.900-468.0*	103028X	Kit 28, Plunger Repair
8.900-471.0*	103029X	Kit 29, Plunger Repair
8.900-476.0	103037X	Kit 37, Oil Seal
8.900-485.0	103083X	Kit 83, Oil Seal
8.900-492.0	103097X	Kit 97, Packing

\*These are old style kits to replace components in Interpump / General pumps with two brown Buna-V packings (pumps built before the change was made to restop ring and black low-pressure seals).

**PISTON PUMPS**



8.702-156.0

- Temperature Max (except 5321): 140° F
- Temperature Max (for 5321): 180° F
- Cast Iron Body
- Stainless-Steel Check Valves
- Complete With Base or Torque Arm
- Buna Cups
- 1/2 NPT Ports

PART NO.	OLD NO.	HYPRO	GPM	PSI	RPM
Solid Shaft					
8.702-158.0	100319	5320	2.0	500	1750
8.702-161.0	100322	5321	2.2	1000	1750
8.702-167.0	100331	5330	3.0	500	1750
Hollow Shaft					
8.702-156.0	100315	5315	1.5	500	1750
8.702-159.0	100320	5320	2.0	500	1750
8.702-160.0	100321	5321	2.2	1000	1750
8.702-166.0	100330	5330	3.0	500	1750
8.702-146.0	100301	Injector Head 5320 / 5330 Pump			
8.702-152.0	100306	Injector Head 5321 / 5324 Pump			

**PUMP PARTS AND TOOLS**



For 5300 series pumps.



Valve Seat Tools

Piston Repair Kit

Valve Cage Tools

- A necessity for working on 5300 series pumps
- Rugged Construction

PART NO.	OLD NO.	DESCRIPTION
8.722-629.0	H34300010	Piston Repair Kit, Model 5320 Pump
8.722-634.0	H34300144	Piston Repair Kit, Model 5321 Pump
8.722-641.0	H34300197	Check Valve Kit, All 5300 Pumps
8.712-510.0	449052	Valve Cage Tool
8.712-512.0	449071	Valve Seat Tool

Note: Piston Repair Kits have Buna Seal

## JETTER PULSE VALVES



- Replaces valve cap to create pulsation action, to move nozzle in pipe cleaning applications.

PART NO.	OLD NO.	DESCRIPTION
8.755-228.0		For Legacy GB / GF / GP Series
8.755-229.0		For Legacy GM Series / GS Series
8.755-230.0		For Legacy GT Series
8.755-231.0		For Legacy GX Series, 4350 PSI
8.712-249.0	410317	For GP 47 Series Pump
8.712-250.0	410318	For GP TT Pumps

## ACCUMULATOR BY INTERPUMP



Pulse dampener.



- PSI Max: 1350
- GPM Max: 10
- 3/4" MPT Connector
- Weight: 1 Lb

PART NO.	OLD NO.	MAX PSI	MAX GPM	DESCRIPTION
8.711-148.0	381110	1350	10	Accumulator

## ACCUMULATOR - PULSE DAMPENER



- Precharge Pressure PSI: 580
- Temperature Max: 180° F

PART NO.	OLD NO.	WORKING PSI	CAPACITY	INLET
8.711-145.0	381102	3100	21.4 CU"	1/2" F
8.711-146.0	381103	3100	6.1 CU"	3/8" F
8.711-147.0	381104	4400	2.5 CU"	3/8" F

## V-PACKING INSERTION TOOL KIT



- Contains inserting tools for installing 20 mm, 22 mm and 24 mm V-packings in the packing gland. Prevents damaged sealing surfaces.

PART NO.	OLD NO.	DESCRIPTION
8.712-519.0	449305	V-Packing Kit
9.109-643.0		V-Packing Kit, 15mm and 18mm, 63 Series

## PACKING EXTRACTOR

Virtually unbreakable sockets will pull packings from Interpump, General and other brand pumps.

Easy to use: Slide-Hammer (shown below) attaches to slotted socket - which expands inside the packing gland. The slide hammer then pops the packing gland brass out of the head to facilitate easy seal repairs without damage to brass support rings.

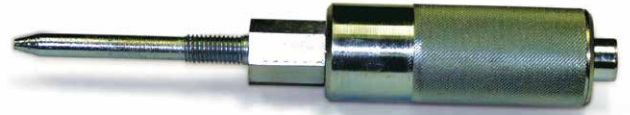

PART NO.	OLD NO.	DESCRIPTION
Slide Hammer		
8.712-513.0	449299	Hammer Only
Sockets for Regular Slide Hammer		
8.712-516.0	449302	18 mm Socket
8.712-515.0	449301	15 mm Socket
8.712-517.0	449303	20 mm Socket
8.712-518.0	449304	22 mm Socket
8.712-520.0	449307	25 mm Socket
Large Slide Hammer		
8.712-521.0	449309	Large Slide Hammer
Sockets for Large Slide Hammer		
8.712-523.0	449311	30 mm Socket
8.712-524.0	449312	38 mm Socket
8.712-525.0	449313	45 mm Socket

## INTERPUMP PACKING EXTRACTOR TOOL

Expansion tool inserts into packing gland to remote lodged packing components



PART NO.	OLD NO.	DESCRIPTION
8.712-522.0	449310	Extractor only
Expansion Sockets for Extractor Above		
8.712-526.0	449315	15 mm, Ref Kit 86 and 97
8.712-528.0	449320	20 mm, Ref Kit 8 and 19
8.712-529.0	449322	22 mm, Ref Kit 12
8.712-530.0	449324	24 mm, Ref Kit 16

Note: 15 mm Expansion Sockets also Fit Admiral Pump W-Series Pumps.

## O-RING TOOL



- Indispensable for Pump Repair
- Excellent for removing O-rings, seals, and more
- 6" Long Dental Pick
- Stainless-Steel
- Knurled Handle
- Double-End

PART NO.	OLD NO.	DESCRIPTION
8.707-467.0	249737	Dental Pick
9.802-568.0	959260	Pliers, Seal Extractor



**PUMP OIL**



- Quality mineral base lubricating oil ideal for use in high pressure piston precision plunger pumps. Blended with wear, rust and foam inhibitors.

PART NO.	DESCRIPTION
8.923-425.0	Pump Oil 10W40, Quart

**PUMP LUBE**



- A premium-quality lubricating oil fortified with additives to reduce friction, foaming and corrosion.
- Ideal for use in heavy industrial applications requiring hydraulic based lubricant.

PART NO.	OLD NO.	DESCRIPTION
8.756-854.0	112056	Pump Lube, Quart
9.808-016.0	112076	Case Lot, Qty 12

**PUMP LUBE**



- General Pump gear lube is a multi-viscosity SAE 80W 90 lubricant with anti-friction, anti-foaming and corrosion-inhibitor additives. Use in Admiral Geared Speed Reducers and Interpump / General RS99, RS151, PTO as well as other high-speed gear boxes.

PART NO.	DESCRIPTION
8.756-728.0	Gear Lube, 2-1/2 Gallons

**COMPLETE PUMP EXTRACTION KIT**



- 13 mm - 24 mm in a Carrying Case
- Slide Hammer
- 13 mm, 15 mm, 18 mm, 20 mm, 22 mm and 24 mm Sockets
- Fits General Pumps

PART NO.	DESCRIPTION
8.723-619.0	Extraction Kit

**GEAR REDUCTION**



Specifically designed for Legacy and Admiral pumps.



- Engine-to-Pump Drive Units
- 2.1 to 1 Reduction Ratio (3,675 Eng. RPM = 1,750 Pump RPM)
- Engine Shaft Size = .0984" or 1" or 1-1/8"

PART NO.	OLD NO.	DESCRIPTION
8.710-332.0	349120	24 mm Pump x 1" Engine
8.710-333.0	349121	30 mm Pump x 1" Engine
8.715-344.0		25 mm Pump x 1" Engine
8.715-342.0		24 mm Pump x 1" Engine
8.749-925.0		24 mm Pump x 0.984" Engine
8.749-922.0		24 mm x 3/4" Engine
8.754-767.0		25 mm Pump x 1-1/8" Engine

**GEAR REDUCTION**



Fits Admiral, Interpump, AR, Comet, Udor and Hawk.



- Engine-to-Pump Drive Units
- 2.18 to 1 Reducer
- For 11-18 HP Gasoline Engine
- For Pumps with a 24 mm Shaft

PART NO.	OLD NO.	DESCRIPTION
8.710-335.0	349130	1" Engine Shaft
8.710-336.0	349131	1-1/8" Engine Shaft

**ANTI-SEIZE COMPOUND**

Recommended for all metal-to-metal, power-drive assemblies. Facilitates removal after use.



- Copper-Graphite or Nickel
- Copper-graphite high-torque for high temperature to 1800° F
- Nickel continues to work up to 2400° F
- Stops rust, galling and seizure on pulley / shaft or gear / shaft interfaces

PART NO.	OLD NO.	DESCRIPTION
8.704-638.0	112299	Blister Pack, 1 application, Copper - Graphite
8.704-641.0	112305	8 oz Brush Top Can - Nickel

## GEARED REDUCTION UNITS INTERPUMP / GENERAL



For use with 1,450 RPM Interpump, General Pumps and Admiral A-W99.

RS99: 2.4:1 Gear Reduction (3,480 Engine RPM = 1,450 RPM Pump) for 3-5 HP Briggs, Honda-Tecumseh-Kohler with 3/4" Shaft.

RS151: 2.2:1 Gear Reduction (3,190 Engine RPM = 1,450 RPM Pump) for 7-18 HP Briggs, Honda Engines with 1" or 1-1/8" Shaft (must specify). Use with the appropriate size: "WS" Series Interpump, "TS" Series General Pump.



8.710-321.0



8.710-322.0

- Eliminates Belts, Pulleys and Belt Guards
- Engine-to\_Pump Drive Units
- Improve Efficiency

PART NO.	OLD NO.	ENGINE SHAFT
RS-99		
8.710-321.0	349009	3/4"
RS-151		
8.710-322.0	349011	1"
8.710-324.0	349013	1-1/8"

## PTO GEARED MULTIPLIER



- 1 to 1.9 Speed Multiplier
- 1-3/8" Splined Shaft (Same shaft as standard tractor PTO)
- 540 RPM PTO speed multiplied to 1,026 RPM at pump shaft
- For Pumps with a 24 mm Shaft

PART NO.	OLD NO.	DESCRIPTION
8.710-319.0	349005	Gear Multiplier

## PUMPTech PUMP

The PumpTech Pump is a twin plunger design originally used on the Hotsy model Sport 500.

- PSI Max: 1000
- GPM Max: 2.0

PART NO.	OLD NO.	DESCRIPTION
8.715-240.0	830065	Pump-Sport 500
8.707-369.0	753170	Cranshaft
8.707-370.0	753168	Seal Kit w/Plunger
8.700-187.0	753169	Check Valve Kit

Specifications, product descriptions and product availability subject to change without notice.

## FLANGES



- Direct attachment of Legacy Pumps to NEMA Standard C-Face Motors.

PART NO.	NEMA FRAME	PUMP SERIES
8.754-098.0	184 TC / 215 TC	GM
8.754-099.0	184 TC / 215 TC	GT-GX

## FLEX COUPLERS



- Pump shaft couplers. Direct-drive self-adjusting resilient coupling Legacy pumps to NEMA Standard Motor Shafts.

PART NO.	OLD NO.	PUMP SERIES	MOTOR DRIVE COUPLING
8.754-100.0	184 TC	GM	1-1/8" x 24 mm
8.754-101.0	215 TC	GM	1-3/8" x 24 mm
8.754-102.0	184 TC	GT-GX	1-1/8" x 25 mm
8.754-103.0	215 TC	GT-GX	1-3/8" x 25 mm

## FLANGES



- Direct attachment of Interpump / General Pumps to NEMA Standard C-Face Motors.

PART NO.	OLD NO.	NEMA FRAME	PUMP FRAME SIZE
8.709-613.0	336020	56 / 145TC	W973
8.709-615.0	336024	184TC*	W995
8.709-616.0	336025	215TC**	W913
8.709-870.0	339120	8-13 HP (G)	WW161

\*W995 / GD \*\*W913 / GM

## FLEX COUPLERS



- 24 mm pump shaft couplers. Direct-drive flex coupling 24 mm Interpump / General and Admiral XLS Series pumps to NEMA Standard Motor Shafts.

PART NO.	OLD NO.	NEMA FRAME	DRIVE SHAFT
2-Piece Coupler			
8.709-617.0	336028	56 A	5/8"
8.709-619.0	336030	145T	7/8"
8.709-621.0	336032	184 T	1-1/8"
8.709-624.0	336036	215 T	1-3/8"
8.709-869.0	339112A	Gas (Aluminum)	1"
8.701-262.0	080320	Rubber Bumper - Replacement	

**PUMP TECHNICAL INFORMATION**

Correct pump installation is essential for optimum performance. It is recommended that the pump flow capacity be oversized for the actual flow required. For optimum running of the system, the water circulated through the regulating valve should not exceed 10-15% of the pump flow. Recirculating too much water can generate heat in the supply tank increasing the cavitation risk.

FREQUENTLY ASKED QUESTIONS	ANSWERS			
How much should you reduce the pump RPM to achieve a lower flow capacity?	Required RPM	=	Expected Capacity	x $\frac{\text{Max RPM Allowed}}{\text{Max Allowed Capacity}}$
What diameter of pulley must I use to achieve the correct pump RPM?	$\frac{\text{External Diameter of the Engine}}{\text{Motor Pulley}}$	=	External Diameter of the Pump Pulley	x $\frac{\text{Pump RPM}}{\text{Engine / Motor RPM}}$
What if I cannot change the engine / motor pulley?	External Diameter of the Pump Pulley	=	$\frac{\text{External Diameter Engine}}{\text{Motor Pulley}}$	x $\frac{\text{Engine / Motor RPM}}{\text{Pump RPM}}$
If the engine / motor is running at a lower RPM than the maximum pump RPM allowed, what will be the pump flow capacity?	Attainable Maximum Capacity	=	Engine / Motor RPM	x $\frac{\text{Max Capacity Indicated on Label}}{\text{Max RPM Indicated on Label}}$
What is the approximate power required to achieve the maximum performances allowed?	Required Electric Motor HP	=	Electric Motor HP	$\frac{\text{PSI x GPM}}{1460}$
	Required Gas Engine HP		$\frac{\text{PSI x GPM}}{1460}$	x 1.30 = Gas Engine HP

Conditions to prevent pump cavitation: Minimum difference in height HZ (Pos / Neg) between pump and water level.

The minimum inlet pressure value of the pump is limited by the cavitation phenomenon. Cavitation is the forming of vapor bubbles when the local pressure is below the vapor pressure of the liquid. Bubbles flow together with the liquid and when they reach a higher pressure area, they collide, generating abnormal stresses that are extremely dangerous to the pump components. To avoid the risk of cavitation, it is necessary that the pump installation is correct.

## LEGACY UNIVERSAL UNLOADER (UU1)

The Legacy Universal Unloader is unique in that it allows for height or width adjustments making it ideal for any pump.



- PSI: 3500
- GPM: 6.0
- Temperature: 195°F
- Forged-Brass Body
- 1/2" NPT Inlet
- 3/8" NPT Outlet
- Stainless-Steel and low friction, wear-resistant plunger
- Weight: 16.1 oz
- Patent US 8,313,311 B2

PART NO.	DESCRIPTION
----------	-------------

9.175-018.0	Legacy Universal Unloader (UU1)
-------------	---------------------------------

Please Note: Legacy Universal Unloader (UU1) will not fit Legacy Pump GF 3530F

### Adjusting inlet port

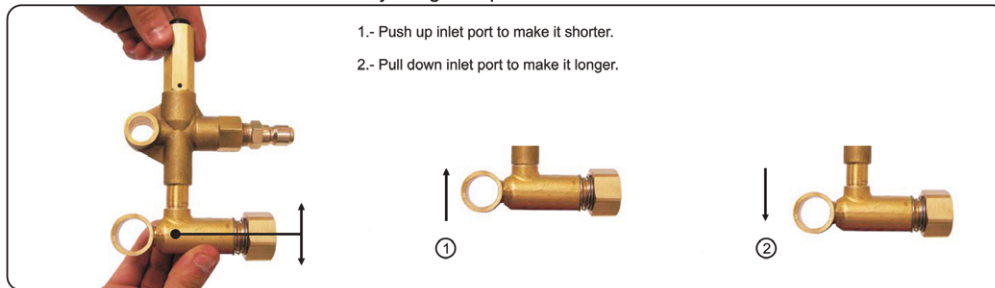

### Adjusting horizontal sliding connector

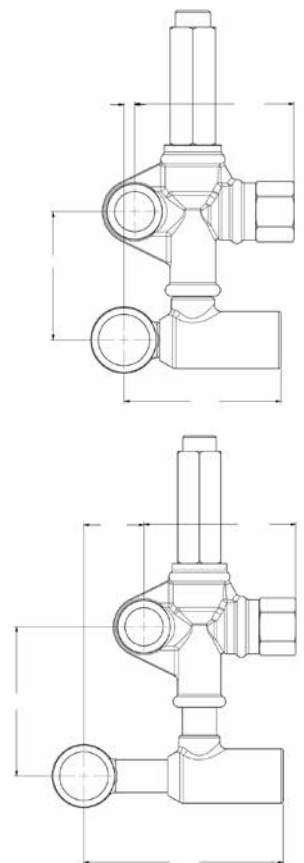
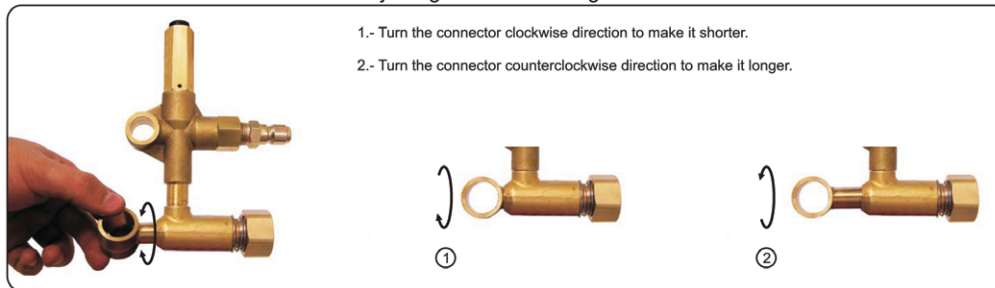

## VBT UNLOADER

A trapped pressure direct mount unloader valve.

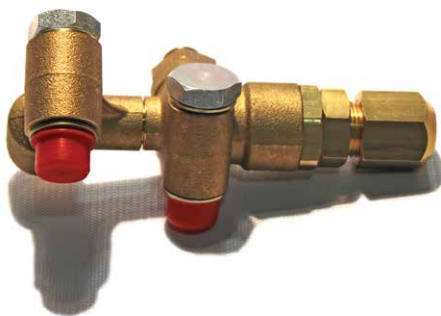

- PSI: 1500 - 4000
- GPM: 6.6
- Temperature: 195°F
- 1/2" FPT Inlet x 3/8" MPT Outlet
- Weight: 1.95 oz
- Brass, Stainless, Buna-N

PART NO.	DESCRIPTION	PSI	FITS PUMP
----------	-------------	-----	-----------

8.754-696.0	Unloader, VBT Direct Mount	3000	LB, LP, LF
8.754-700.0	Unloader, VBT Direct Mount	4000	LB, LP, LF
8.754-701.0	Unloader, VBT Direct Mount	4000	LB, LP, LF
8.754-702.0	Unloader, VBT Direct Mount	4000	LM, LS

### AUTOMATIC PRESSURE REGULATOR

Integral Regulator for Admiral Pumps: WE - WG - WEL - XLS - XLE - XLG bolt on for Admiral and Legacy pumps. Trapped-pressure regulator specifically designed for use on the Admiral plunger pumps. Integral inlet, bypass and outlet eliminate the need for bypass hose.



8.703-401.0

- PSI: 3200
- GPM: 6.0
- Temperature: 195°F
- Forged-Brass Body
- 3/8" MPT Outlet
- Stainless-Steel Plunger and Seat Valve
- Weight: 29 oz.

PART NO.	OLD NO.	DESCRIPTION	INLET
8.703-401.0	106020	APR-Brass / Black	3/8"
9.802-365.0	106022	APR-Brass / Black	1/2"
8.900-760.0	109139	Seal Repair Kit	3/8"
8.900-761.0	109139X	Seal Repair Kit	1/2"
8.900-762.0	109140	Valve Seat Repair Kit	

### REGULATORS / UNLOADERS

Basic valves, premium performance.



- Temperature: 194°F
- Forged-Brass Body
- Stainless-Steel Seat and Piston
- 3/8" MPT Inlet, Outlet and Bypass

#### 520 Regulator / Unloader

- PSI: 2000
- Tested Up To 2400 PSI
- GPM: 8.0
- Weight: 15 oz

#### VR54 Black Regulator / Unloader

- PSI: 2175
- Tested Up To 2800 PSI
- GPM: 8.0
- Weight: 15 oz

#### VR54 Red Regulator / Unloader

- PSI: 2900
- Tested Up To 2800 PSI
- GPM: 8.0
- Weight: 13.7 oz

#### VR65 Regulator / Unloader

- PSI: 3625
- Tested Up To 3400 PSI
- GPM: 8.0
- Weight: 15 oz

#### Repair Kits

- For use with 520 regulator / unloaders

PART NO.	OLD NO.	DESCRIPTION
8.712-589.0	462320K	520 w/Knob
8.704-004.0	109178	Valve Seat Repair Kit
8.753-028.0		VR54 Black
8.753-029.0		VR54 Red
8.753-017.0		VR56 w/Knob

### REGULATOR / UNLOADER VRS3



- PSI: 3630
- GPM: 8.0
- Temperature: 194°F
- 3/8" MPT Inlet and Outlet, 1/4" FPT Bypass
- Adjustable Pressure Setting Nut
- Heavy-Duty Forged-Brass Body
- Stainless-Steel Ball and Valve Seat
- High-Temperature Viton Seals
- Adjustable Upper-Pressure Limit Lock

PART NO.	DESCRIPTION	PSI	GPM
8.753-027.0	without Knob	3630	8
8.753-026.0	with Knob	3630	8

### VBA35 / VB55 UNLOADER VALVES FOR LEGACY HD PUMPS

- PSI: 3500
- GPM: 6.6



PART NO.	DESCRIPTION	PSI	GPM
VBA35 for Legacy HD Models			
9.803-899.0	GG, GD, GE	3500	6.6
9.803-900.0	GM, GS	3500	6.6

- PSI: 3650
- GPM: 8.0

PART NO.	DESCRIPTION	PSI	GPM
VB55 for Legacy HD Models			
9.802-363.0	GM, GS	3650	8

### REGULATORS / UNLOADERS

Basic valves, premium performance.



- PSI: 4500
- GPM: 8.0
- Temperature: 200°F
- Forged-Brass Body
- Stainless Internals
- 3/8" Inlet, Outlet, Bypass

PART NO.	DESCRIPTION	PSI	GPM
8.750-297.0	Yellow	2320	8
8.750-298.0	Blue	3630	8
8.750-299.0	Black	4500	8
8.750-300.0	W/ EZ Start, Black	4500	8
8.750-955.0	W/ Switch, w/o Knob	4500	8
8.750-956.0	W/ Switch, w/ Knob	4500	8
8.750-709.0	Repair Kit, VRT3	2320 / 3630	8
8.750-710.0	Repair Kit, VRT3	4500	8
9.802-694.0	Repair Kit Old Style VRT 605, 606, 607	Up to 4500	8



**VRT100 UNLOADER VALVES**



- PSI: 5075
- GPM: 26.4
- Temperature: 194°F
- 1/2" Inlet, Outlet, Bypass
- Stainless Internals
- Forged-Brass Body

PART NO.	DESCRIPTION	PSI	GPM
8.753-726.0	Blue	Up to 5075	26.4
8.753-443.0	Yellow	Up to 5075	26.4
8.753-444.0	Blue	Up to 5075	26.4
8.753-727.0	Blue Microswitch 120 / 240 VAC	Up to 5075	26.4
8.754-012.0	VRT100 Repair Kit	Up to 5075	26.4

**PULSAR UNLOADERS**



- GPM: 8.0
- Temperature: 195°F
- Pulsar 4 blue rated 3200 PSI, Max PSI: 3650
- Pulsar 4 white rated 1400 PSI, Max PSI: 1750
- Pulsar 280 HP rated 4050 PSI, Max PSI: 4350
- All Stainless-Steel Valves
- Pressure Actuated
- Forged Body
- 3/8" FPT Inlet, Outlet
- Two 3/8" FPT Bypass Ports

PART NO.	OLD NO.	DESCRIPTION	GPM
8.712-653.0	462654	Pulsar 4, White, w/Knob	8
8.704-462.0	111100	Repair Kit - Pulsar 4	8
9.802-004.0	111375	Repair Kit - 280 HP	8
8.754-866.0		Pulsar 4 RV, w/o Knob	8
8.752-788.0		Pulsar 4, Blue Spring w/ Knob & Switch	8

**VB7 REGULATOR / UNLOADER**



Fits CAT 4SF pumps and other pumps with 7.8 GPM - 3600 PSI max pressure



- PSI Max: 3200
- Temperature: 200°F
- 3/8" MPT Inlet, 1/4" FPT Gauge Port
- 3/8" FPT Outlet and Bypass
- Weight: 19.7 oz

PART NO.	OLD NO.	DESCRIPTION	PSI	TEMP
8.712-741.0	463670	Without Knob	3200	200° F
8.904-580.0	463670K	With Knob	3200	200° F
8.704-488.0	111175	Repair Kit	3200	200° F
8.712-735.0	463600	Knob Only	3200	200° F

**VB130 REGULATOR / UNLOADER**



Fits CAT 2SF pumps and other pumps with 6.6 GPM - 2600 PSI max pressure.



- PSI Max: 2300
- Temperature: 200°F
- 3/8" MPT Inlet and Outlet
- 3/8" FPT Bypass
- Stainless-Steel Plunger
- Stainless-Steel Valve Seat
- Weight: 14.7 oz

PART NO.	OLD NO.	DESCRIPTION	PSI	TEMP
8.712-739.0	463660	Without Knob	2300	200° F
8.904-579.0	463660K	With Knob	2300	200° F
9.802-006.0	111150	Repair Kit	2300	200° F
8.712-735.0	463600	Knob Only	2300	200° F

**VB85 / 820 REGULATOR / UNLOADER**



Fits CAT 2SF pumps and other pumps.



- GPM: 21
- Temperature: 200°F
- Pressure Actuated
- Forged-Brass Body
- Stainless-Steel Plunger and Seat
- 1/2" FPT Inlet, Outlet, Bypass
- Weight: 45 oz

PART NO.	DESCRIPTION	PSI	GPM	TEMP
8.751-964.0	VB85, 1/2" NPT, Blue Spring	4050	21	200° F
8.751-963.0	VB85, 1/2" NPT, Blue Spring	2300	21	200° F

**VB200 / 150 HIGH-VOLUME UNLOADER**



Fits CAT 2SF pumps and other pumps.



- PSI: 2175
- GPM: 52.5
- Temperature: 194°F
- Forged-Bronze Body
- Large Plastic Knob (Removable)
- Lock Nut on Pressure Adjustment
- 1" FPT Inlet, Outlet, Bypass
- Two 5/16" - 18 Bolt Mounting Ports
- Weight: 73.5 oz

PART NO.	OLD NO.	DESCRIPTION	PSI	GPM
8.712-754.0	463714	VB 200 / 150 Without Knob	2175	52.5
8.712-755.0	463715	VB 200 / 150 With Knob	2175	52.5
8.704-583.0	111550	Repair Kit	2175	52.5

**VB75 / VB135**

The VB75 is an integrated unloader for Interpump and General pumps with 7.8 GPM - 3600 PSI max pressure. The VB135 fits Interpump "WW" Series pumps and General "TT" Series pumps with 6.5 GPM - 2600 PSI max pressure.



**VB75**

**VB75**

- PSI: 3200
- Temperature: 200°F
- 1/2" MPT Inlet, 1/4" FPT Gauge Port
- 3/8" FPT Outlet and Bypass
- Weight: 19.7 oz.



**VB135**

**VB135**

- PSI: 2300
- Temperature: 200°F
- 3/8" MPT Inlet, 1/4" FPT Outlet
- Stainless Internals
- Forged-Brass Body
- Weight: 22.9 oz.

PART NO.	OLD NO.	DESCRIPTION	TEMP
VB75			
8.712-742.0	463672 / 462646	Series 44 EZ and 47 Pumps W151	200° F
8.704-488.0	111175	Seal Kit	200° F
8.712-735.0	463600	Knob Only	200° F
8.705-934.0		1/2" Bolt with Hole	200° F

VB135			
8.712-659.0	462659	VB 135	200° F
8.712-735.0	463600	Knob Only	200° F
9.802-006.0	111150	VB 135 Repair Kit	200° F
8.705-935.0		3/8" Bolt with Hole	200° F

**VB80 / 400 STAINLESS-STEEL UNLOADER**



- PSI: 5800
- GPM: 21.0
- Temperature: 195°F
- Forged Stainless-Steel Body
- All Stainless-steel Valve Parts
- Viton Seals
- 1/2" FPT Inlet, Outlet, Bypass

PART NO.	OLD NO.	DESCRIPTION	GPM	TEMP
8.712-656.0	462656	VB 80/400	21	195° F
9.802-007.0	111340	Repair Kit	21	195° F

**TRAPPED PRESSURE UNLOADER VALVES VB10 / VB9**



- PSI: 3600
- Rated PSI: 3200
- GPM: 7.8
- Instant Pressure Response
- Hex-Shaped Non-stick Check Valve
- 3/8" Inlet, Outlet, Bypass
- Brass Valve Body / Stainless Ball and Seat
- Knob Included
- VB9 - Panel Mountable
- Reduces trapped pressure to 25% of operating pressure when unloading; allows easier gun trigger pull

PART NO.	OLD NO.	DESCRIPTION
8.712-736.0	463650	VB9 with Knob
8.715-462.0		VB9 with Knob and Pressure Switch
8.715-489.0		VB9 with Check Valve and Pressure Switch
8.712-745.0	463675	VB10 with Knob
8.704-548.0	111336	Repair Kit VB9
8.704-561.0	111400	Repair Kit VB10
8.901-056.0	111401	Seal Kit VB10

**VB350 / 4 UNLOADER**



Bigger. Stronger. Faster - 5600 PSI.



- PSI Max: 5600
- Rated PSI: 5100
- GPM: 10.5
- Temperature Max: 195°F
- Forged-Bronze Body
- Stainless-Steel Plunger and Valve Seat
- 3/8" FPT Outlet and Bypass
- 1/2" F Bypass
- 3/8" MPT Inlet, 1/4" Gauge Port
- Weight: 31 oz

PART NO.	OLD NO.	DESCRIPTION	TEMP
9.802-360.0	463680K	Unloader, Red Knob	195° F
8.704-499.0	111200X	Repair Kit, Old VB 350	195° F
9.800-106.0	111901	Repair Kit, Red Knob	195° F

## CONTROL SET "W" SERIES / INTEGRATED REGULATOR/UNLOADER



Designed exclusively to fit Interpump and General pumps.



- Mounts directly on pump inlet and outlet; internal bypass loop.
- Pressure Actuated: "Instant-On"
- 3/8" MPT Outlets
- Integrated Injector - Optional
- Pressure and flow-engineered for specific pump models

PART NO.	OLD NO.	MODEL	GPM	FITS PSI	PUMP
<b>"W" Series Unloaders</b>					
8.712-638.0	462636	W1	4.00	1600	W905
8.712-643.0	462643	W2	5.56	3000	W997
8.712-644.0	462644	W2-L	5.56	3000	W201
8.702-883.0	103093B	W2 / W2L Rebuild Kit			
8.702-888.0	103098B	W1 / W1L Rebuild Kit			

<b>"W" Series Unloaders with Injectors</b>					
8.712-642.0	462642	W2-1	2.9-4.0	3000	W997
8.712-645.0	462645	W2L-1	2.9-4.0	3000	W201
8.712-647.0	462647	W2L-2	4.2-5.5	3000	WS202
8.702-884.0	103094B	Injector Maintenance Kit			

## "K" SERIES PRESSURE REGULATORS KITS



Repair Kits for all K3, K5, K7 and K9 models.

PART NO.	OLD NO.	DESCRIPTION
8.702-847.0	103058B	K5 Maintenance Kit
8.702-849.0	103060B	K5 Rebuild Kit
8.705-045.0	140070	K5 Back Nut 3/4" NPT
8.702-858.0	103070B	K7 Repair Kit
8.702-911.0	103121B	K9 Repair Kit

## "K" SERIES PRESSURE REGULATORS



Unloaders relieve line pressure in bypass mode.

- Temperature: 165°F
- 1/2" FPT B
- 3/8" FPT Inlet

PART NO.	OLD NO.	MODEL	GPM	OUTLET
<b>K3</b>				
8.712-603.0	462530A	K3.0	2.10-2.90	3/8" M
8.712-605.0	462531A	K3.1	2.90-4.22	3/8" M
8.712-607.0	462532A	K3.2	4.22-5.55	3/8" M
8.712-609.0	462533A	K3.3	5.00-6.50	3/8" M
8.712-604.0		K3.0	2.10-2.90	1/2" M
8.712-606.0		K3.1	2.90-4.22	1/2" M
8.712-608.0		K3.2	4.22-5.55	1/2" M
8.712-610.0		K3.3	5.00-6.50	1/2" M

<b>K5</b>				
8.712-611.0	462551A	K5.1	2.90-4.22	3/8" M
8.712-613.0	462552A	K5.2	4.22-6.60	3/8" M
8.712-615.0	462553A	K5.3	6.60-10.83	3/8" M
8.712-612.0		K5.1	2.90-4.22	1/2" M
8.712-614.0		K5.2	4.22-6.60	1/2" M
8.712-616.0		K5.3	6.60-10.83	1/2" M

Note: 1. Use 8.705-045.0 back nut on bypass nipple when mounting 1/2" bypass line on K3s and K5s. 2. Use restricted .156-.225 ID orifice in bypass line for smoother operation / pressure balancing.

PART NO.	DESCRIPTION
8.715-478.0	Bypass plate for K3 / K5
8.701-386.0	K7 - #0 Bypass Orifice 2.2 mm
8.701-389.0	K7 - #1 Bypass Orifice 2.5 mm

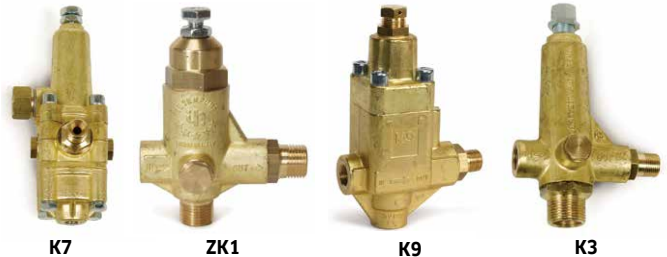

- Temperature: 165°F
- 3/8" FPT

PART NO.	OLD NO.	MODEL	GPM	OUTLET
8.712-617.0	462570	K7.0	2.11-2.90	3/8" M
8.712-618.0	462571	K7.1	2.90-4.22	3/8" M
8.712-619.0	462572	K7.2	4.22-6.60	3/8" M
8.712-620.0	462573	K7.3	6.60-10.8	3/8" M

- GPM: 2.3-10.8
- Temperature: 165°F
- 3/8" Inlet BSP-F

PART NO.	OLD NO.	MODEL	OUTLET / BYPASS
8.712-602.0	462526	2K138	3/8" BSP-M
8.712-601.0	462525	ZK1	1/2" BSP-M

- Temperature: 165°F
- 1/2" FPT

PART NO.	OLD NO.	MODEL	GPM	OUTLET
8.712-621.0	462574	K9	13.2	1/2" M

**REGULATOR / UNLOADER - HM**



- Pressure Adjustable: 0-3000 PSI
- Flow Range: 1.4 to 10.8 GPM
- 3/8" FPT Inlet, Bypass, 3/8" MPT Outlet
- Excess flow bypassed to maintain selected pressure
- Will operate on single / multiple gun systems
- Brass Body, Stainless-Steel Valve & Seat

PART NO.	OLD NO.	DESCRIPTION	GPM	PSI
8.712-622.0	462575	HM Regulator / Unloader	1.4-10.8	0-3000
8.702-860.0	103072B	Repair Kit	1.4-10.8	0-3000

**UNLOADER - HYPRO-STYLE**



- PSI: 400 to 1500
- GPM: 5.0
- Temperature: 180°F
- 3/8" MPT Inlet and Outlet
- Buna Seals
- Weight: 8 oz

PART NO.	OLD NO.	PRESSURE	BYPASS	GPM
8.712-689.0	462739	200-500	1/4" FPT	5.0
8.712-690.0	462740	400-1000	1/4" FPT	5.0
8.712-691.0	462743	800-1500	1/4" FPT	5.0
8.712-692.0	462745*	400-1000		5.0
8.712-693.0	462748*	800-1500		5.0
8.722-643.0	H343002233	Repair Kit for All		

\*Bypass port not threaded, closed coupled

**UNLOADER - YU - HIGH VOLUME**



- GPM: 21.0
- Temperature: 200°F
- 1/2" FPT Inlet and Outlet
- 2-1/2" FPT Bypass Ports
- Forged-Brass Body
- Stainless-Steel Internals

**YU-2121 Yellow Spring**

- PSI: 2300 / Rated Pressure: 2600

**YU-2140 Green Spring**

- PSI: 4050 / Rated Pressure: 4500

PART NO.	DESCRIPTION	GPM	PSI	TEMP
8.753-326.0	YU-2121 Yellow Spring	21.0	2300	200° F
8.753-168.0	YU-2140 Green Spring	21.0	4050	200° F

**REGULATOR / UNLOADER - HM**



- Pressure Regulation: 0-3600 PSI
- GPM: 8.0
- Temperature: 200°F
- 1/4" FPT Inlet and Bypass
- Mounts Off-Line - No Line Restrictions
- Brass Body, Stainless-Steel Piston & Seat
- Weight: 14 oz

PART NO.	OLD NO.	DESCRIPTION	GPM	PSI	TEMP
8.712-628.0	462590	ST-230	8	0-3600	200° F
8.701-626.0	087926	Repair Kit	8	0-3600	200° F

**REGULATOR / UNLOADER - ST-261**



**ST-261 Standard**

- PSI Regulation: 0-3600
- GPM: 8.0
- Temperature: 180°F
- Stainless-Steel Plunger and Seat
- Forged-Brass Body and Viton Seals
- Weight: 22.5 oz

PART NO.	OLD NO.	DESCRIPTION	GPM	PSI	TEMP
8.712-681.0	462690	ST-261 STD	8	0-3600	180° F
8.900-156.0	088211X	Seal Kit	8	0-3600	180° F
8.701-627.0	088209	Repair Kit "B"	8	0-3600	180° F
8.701-650.0	088466	Outlet Check Kit "A"	8	0-3600	180° F



**ST-261 / S Unloader with Bypass Switch**

- 10 AMP, 110 / 230V
- Switches at full bypass flow
- Wired N/C (may be wired N/O)

PART NO.	OLD NO.	DESCRIPTION
8.712-685.0	462695	ST-261 / S
8.701-647.0	088422	Switch Seal Kit



**ST-261 / 1 Unloader with Chemical Injector**

PART NO.	OLD NO.	DESCRIPTION	GPM
8.712-682.0	462691	ST-261 / I-1	0.0-2.4
8.712-683.0	462692	ST-261 / I-2	2.4-3.5
8.712-684.0	462693	ST-261 / I-3	3.5-5.5
8.900-159.0	088260X	Injector Repair without Barb	
8.701-648.0	088424	Injector Repair with Barb	



**ST-261 / SI Unloader with Switch and Injector**

- 10 AMP, 110 / 230V
- Switches at full bypass flow
- Wired N/C (may be wired N/O)

PART NO.	OLD NO.	DESCRIPTION	GPM
8.712-686.0	462696	ST-261 / SI-1	0.0-2.4
8.904-576.0	462697	ST-261 / SI-2	2.4-3.5
8.904-577.0	462698	ST-261 / SI-3	3.5-5.5



**ST-261 Bypass Switch Only**

- Field-Mountable
- 10 AMP, 115 / 230V
- Switches at full bypass flow
- Wired N/C (may be wired N/O)

PART NO.	OLD NO.	DESCRIPTION
8.712-629.0	462626	Switch Assy Complete
8.701-642.0	088272	Micro Switch Only
8.701-647.0	088422	Seal Kit - Micro Switch

**REGULATOR / UNLOADER - ST-280**



- PSI: 3600
- GPM: 8.0
- Temperature: 175°F
- Brass Housing, Stainless-Steel Valve
- 3/8" FPT Inlet, Outlet and 1/4" FPT Bypass
- Weight: 22.5 oz

PART NO.	OLD NO.	DESCRIPTION	GPM	PSI
8.712-674.0	462680	ST-280	8	3600
8.701-655.0	088536	Seat Repair Kit "D"	8	3600
8.701-654.0	088535	Piston Seal Kit "C"	8	3600
8.701-653.0	088534	Poppet Repair Kit	8	3600

**UNLOADER - AR BOLT-ON**



- PSI Rated Pressure: 2600
- Fits XT and XM Series Pumps
- 1/2" F Inlet
- 3/8" M Outlet

PART NO.	OLD NO.	DESCRIPTION	GPM	BYPASS
8.712-582.0		AR20608	3.0-5.5	AL, No Injector
8.712-564.0	462228	AR20821	2.0-5.0	AL, No Injector
8.712-573.0	462243	AR20890	2.0-3.0	AL, Adj Injector
8.712-576.0	462246	AR21039	2.0-3.0	Brass, Adj Injector
8.712-575.0	462245	AR21040	3.0-4.0	Brass, Adj Injector
8.720-676.0	AR002812	Seal Kit		

Note: AR has discontinued the Combiset unloaders. Use Mini-Mate unloaders as replacements. For 22 mm twist coupler outlet models, add Part No. 8.709-546.0 (3/8" x 22 mm) to injector outlet.

**UNLOADERS - GYMATIC**



- PSI Rated Pressure: 3650
- GPM: 3.0-5.5
- Fits XT and XM Series Pumps
- 3/8" M Outlet

PART NO.	OLD NO.	DESCRIPTION	INLET
8.712-565.0	462229	AR20242	1/2" F without Injector
8.712-563.0	462226	AR20242G	3/4" GHF without Injector
8.712-574.0	462244	AR20081	1/2" M Fixed Injector #1, 2-3 gal
8.712-567.0	462233	AR20082	1/2" M Fixed Injector #2
8.712-568.0	462235	AR20399	1/2" M Adj Injector #1, 2-3 gal
8.712-569.0	462236	AR20400	1/2" M Adj Injector #2
8.720-642.0	AR002611	Repair Kit	

- PSI Max: 4000
- GPM: 5.0
- 1/2" M Inlet
- 3/8" M NPT
- Brass Bypass
- Without Injector

PART NO.	OLD NO.	DESCRIPTION	INLET	OUTLET
8.712-583.0	462255	AR21669	1/2" M	3/8" M NPT

- PSI Max: 4000
- GPM: 5.0
- 1/2" F Inlet
- 3/8" M Outlet
- Brass Bypass

PART NO.	OLD NO.	DESCRIPTION	INLET	OUTLET
8.720-903.0	AR20992	AR20992G	1/2" F	3/8" M

Specifications, product descriptions and product availability subject to change without notice.

**UNLOADERS - PRESSURE-ACTUATED**



- PSI: 800-3000
- GPM: 13.0
- Temperature: 160°F
- Bellville Spring Washers Minimize Spikes
- Forged-Brass Bodies, Stainless Ball and Seat
- Four 1/4" Side Ports Enhance Versatility
- 1/2" FPT Inlet, Outlet and Bypass Ports
- Weight: 57.3 oz

PART NO.	OLD NO.	MODEL NO.	GPM	PSI	SPRING
8.712-709.0	462934	22910	13	800	Silver
8.712-710.0	462935	22911	13	1400	Yellow
8.712-711.0	462937	22912	13	2400	Red
8.712-708.0	462933	22913	13	3000	Orange
8.722-137.0	G012099	Repair Kit	13		

**UNLOADERS - PRESSURE-ACTUATED**



8.712-705.0



8.712-706.0

- Temperature: 160°F
- Unloads pressure in entire system when in bypass
- Forged-Brass Bodies
- Stainless-Steel Seat
- 3/8" FPT Inlet
- 3/8" FPT Outlet
- 1/4" FPT Bypass

PART NO.	OLD NO.	MODEL NO.	GPM	PSI
8.712-705.0	462927	22760APM	8	3000
8.712-706.0	462928	22765APM	5	4000

**UNLOADERS - PRESSURE-ACTUATED**



- Temperature: 160°F
- Unloads pressure in entire system when in bypass
- Forged-Bronze Body, Stainless-Steel Seat
- 3/8" FPT Inlet, 3/8" MPT Outlet
- 1/2" FPT Bypass

PART NO.	OLD NO.	MODEL NO.	GPM	PSI
8.712-698.0	462909	22650	3.0-4.5	0-3000
8.712-701.0	462913	22654	3.5-4.8	3000-4000
8.712-702.0	462914	22655	4.5-5.5	0-3000
8.712-703.0	462915	22656	4.5-6.5	0-3000
8.722-204.0	G022666	Seal Kit		



**MG4000 SERIES UNLOADERS**



"The world's best unloader valve" with a choice of PSI: 1500, 3000 or 4500.



- PSI: Up to 4500 PSI
- GPM: 10.0
- Temperature: 200° F
- Forged-Brass Body
- 3/8" FPT Inlet, Outlet and Bypass
- Auxiliary 1/4" Outlet
- Can be panel mounted
- Pressure limit indicated with color coded ring

PART NO.	OLD NO.	DESCRIPTION	GPM	PSI
Without Knob				
8.712-715.0	463108	Yellow	10	1500
8.712-718.0	463110	Red	10	3000
8.712-724.0	463114	Black	10	4500
With Knob				
8.712-716.0	463108K	Yellow	10	1500
8.712-719.0	463110K	Red	10	3000
8.712-725.0	463114K	Black	10	4500
8.704-567.0	111442			



- MG4000 with Microswitch**
- PSI: Up to 4500 PSI
  - 15 Amp Microswitch
  - Panel Mountable
  - Use for time-delay shutdown or as burner control
  - Can be used as Normally Open (NO) or Normally Closed (NC)

PART NO.	OLD NO.	DESCRIPTION	AMP	PSI
8.712-717.0	463109K	Yellow	15	1500
8.712-720.0	463111K	Red	15	3000
8.712-714.0	463105K	Blue	15	3600
8.712-727.0	463115K	Black	15	4500

**SAFETY PRESSURE RELIEF VALVE**



"The world's best unloader valve" with a choice of PSI: 1500, 3000 or 4500.



- S-R Safety Valve: PSI: 3000 at GPM: 1.3 to 10.8
- S-3 Safety Valve: PSI: 500 to 10,000 at GPM: 1.3 to 10.8
- Temperature: 165° F
- Bypass and Outlet
- 3/8" MPT Connect x 1/4" MPT
- Stainless-Steel Plunger and Seat
- Machined-Brass Bodies
- Adjustable Pop-Off Protection

PART NO.	OLD NO.	DESCRIPTION	TEMP
8.711-215.0	390103	S-R Valve	165° F
8.711-227.0	390123	S-3 Valve	165° F

**REGULATOR VALVE - TIMEX PRESSURE**



- PSI Max: 1000
- GPM Max: 52
- 3/4" and 1" FPT Inlet and Outlet
- 3/4" FPT Bypass
- Brass-Body, Stainless-Steel Piston and Seat
- Lever control manual dump for bypass to relieve line pressure

PART NO.	OLD NO.	DESCRIPTION	GPM	PSI
8.712-624.0	462580	Timax Regulator Valve	52	1000
8.702-844.0	103051B	Repair Kit		

**REGULATOR - VS 200 / 180 HIGH-VOLUME**



- PSI: 2600
- GPM: 53.5
- Temperature: 194° F
- 3/4" FPT Inlet x 1/2" FPT Bypass
- Weight: 29.4 oz

PART NO.	OLD NO.	DESCRIPTION	GPM	PSI
8.712-753.0	463705	VS 200/180	53.5	2600
8.704-582.0	111520	Repair Kit		

**REGULATOR / RELIEF VALVE - VS 350**



- PSI: 5600
- Rated PSI: 5100
- GPM: 6.5
- Temperature: 195° F
- 3/8" FPT Inlet, Outlet and Bypass
- Weight: 16.8 oz

PART NO.	OLD NO.	DESCRIPTION	GPM	PSI
8.712-756.0	463720	VS 350	6.5	5600
8.704-611.0	111832	Repair Kit		

**REGULATOR / RELIEF VALVE - VS 500 HIGH-PRESSURE**



- PSI Max: 8100
- Rated PSI: 7250
- GPM: 21
- Temperature: 195° F
- 1/2" FPT Inlet and 3/8" FPT Bypass
- Weight: 14.2 oz

PART NO.	OLD NO.	DESCRIPTION	GPM	MAX PSI
8.712-757.0	463725	VS 500	21	8100

## REGULATOR / RELIEF VALVE - VS 220



- PSI Max: 3600
- Rated PSI: 3200
- GPM: 6.3
- Temperature: 200° F
- 3/8" FPT Outlet. Inlets and Bypass
- Forged-Bronze Body
- Stainless-Steel Plunger & Seat Valve
- Compact Design
- Weight: 14.2 oz

PART NO.	OLD NO.	DESCRIPTION	PSI	TEMP
8.712-737.0	463655	VS 220 Without Knob	3200	200° F
8.901-057.0	11576	Repair Kit		

## REGULATING RELIEF VALVE

Economical replacement for paraplate BR5 series.



- Adjustable Pressure: 200-2000 PSI
- GPM: 7
- Temperature: 200° F
- 3/8" FPT Inlet, Outlet and Bypass
- Flow-Thru Design for Smooth Operation
- Machined-Brass Body and Knob
- Stainless-Steel Plunger and Seal

PART NO.	OLD NO.	DESCRIPTION	GPM	PSI
8.712-625.0	462585	Relief Valve	7	200-2000
8.900-042.0	075127	Repair Kit		

## UNLOADER MOUNTING BLOCK

End vibrator-caused fitting failure.



- GPM: 12
- Mounting Hardware Included
- Machine Block Brass or Steel

PART NO.	OLD NO.	DESCRIPTION	MATERIAL	PSI
8.904-568.0	462183X	3/8" x 3/8"	Brass	5500
8.904-567.0	462182X	1/2" x 1/2"	Brass	5500
9.802-870.0		3/8" x 3/8"	Steel	
9.802-871.0		1/2" x 1/2"	Steel	

## CHEM INJECTOR



- PSI: 5500
- Stainless-Steel

PART NO.	OLD NO.	DESCRIPTION	GPM	PSI
9.802-217.0	3-1208	Non-Adjustable, Injector Only	3.0-5.0	5500
9.802-226.0	4-011186	Assembly	3.0-5.0	5500

Specifications, product descriptions and product availability subject to change without notice.

## INJECTOR - AMERIMAX

The higher rate injector. Our best seller!



- PSI: 3500
- Brass Housing
- Stainless-Steel Orifice
- Fully Adjustable Metering Valve
- Stainless-Steel Spring
- 3/8" MPT Inlet, Outlet
- 1/4" Hose Barb

PART NO.	OLD NO.	DESCRIPTION	GPM	PSI
Standard				
8.904-192.0	360130	"0"	1.0-2.0	3500
8.904-193.0	360131	"1"	2.0-3.0	3500
8.903-998.0	360132	"2"	3.0-5.0	3500
8.904-194.0	360133	"3"	5.0-8.0	3500
8.900-040.0	075122X	Repair Kit, Stainless-steel Check Ball		

"Acid" Injector with Special Inlet Check Valve				
8.904-201.0	360140X	"0A"	1.0-2.0	3500
8.904-202.0	360141X	"1A"	2.0-3.0	3500
8.904-203.0	360142X	"2A"	3.0-5.0	3500
8.904-204.0	360143X	"3A"	5.0-8.0	3500
8.700-536.0		Ceramic Ball for 8.904-203.0		
8.900-041.0	075123X	Acid Repair Kit*		

\*Ceramic Check Ball

## QUICK-COUPLED - AMERIMAX



Assembled for added convenience - quick couples to unloader outlet and quick couples hose to injector outlet.



- Top quality quick couplers: 3/8" Plug Inlet, 3/8" Socket Outlet
- 6" industrial-grade poly-braid reinforced tubing (will not collapse, resists crimping, high-chemical tolerance)
- Heavy-duty brass chemical filter with check valve prevent loss of prime

PART NO.	OLD NO.	DESCRIPTION	GPM
Amerimax "QC"			
8.904-195.0	360135X	Quick-Coupled "0"	1.0-2.0
8.904-196.0	360136X	Quick-Coupled "1"	2.0-3.0
8.904-197.0	360137X	Quick-Coupled "2"	3.0-5.0
8.904-199.0	360138X	Quick-Coupled "3"	5.0-8.0
8.900-040.0	075122X	Repair Kit, Stainless-steel Check Ball	

Amerimax Acid "QC"			
8.904-205.0	360145X	Quick-Coupled "0A"	1.0-2.0
8.904-206.0	360146X	Quick-Coupled "1A"	2.0-3.0
8.904-207.0	360147X	Quick-Coupled "2A"	3.0-5.0
8.904-208.0	360148X	Quick-Coupled "3A"	5.0-8.0
8.900-041.0	075123X	Acid Repair Kit*	

\*Ceramic Check Ball

### CHEMICAL INJECTOR - ST-60



Requires ST-61 (below) to regulate chemical injection rate.



- Forged-Brass Body
- Compact Size
- 3/8" MPT Inlet
- 3/8" FPT Outlet

PART NO.	OLD NO.	DESCRIPTION	INLET	OUTLET
8.710-476.0	360120	1.50-2.25, ST 60/0	3/8" MPT	3/8" FPT
8.710-477.0	360121	2.25-3.35, ST-60/1	3/8" MPT	3/8" FPT
8.710-478.0	360122	3.35-5.00, ST-60/2	3/8" MPT	3/8" FPT
8.701-648.0	088424	Repair Kit "F"		

### CHEMICAL METERING VALVE - ST-61



- 1/4" Hose Barb
- Teflon® Seals
- Glass-Filled Polyamide Body and Valve Parts
- Adjusts From Off to Full Flow
- Snap-on attachment to ST-60, ST-62, ST-261/1

PART NO.	OLD NO.	DESCRIPTION
8.710-777.0	371161	ST-61, 1/4" Hose Barb, Teflon® Seals

### CHEMICAL INJECTOR - ST-62 VARIABLE



Flow orifice adjusts for machines from 2-8 GPM. Requires ST-61 to regulate chemical injection rate.



- PSI: 3500
- GPM: 8.0
- Forged-Brass Body

PART NO.	OLD NO.	DESCRIPTION	GPM	PSI
8.710-485.0	360162	ST-62	8	3500
8.701-648.0	088424	Repair Kit "F"		

### INJECTOR - ST-64 UP STREAM



Apply soap at high pressure. Restricts waterflow to create suction.



- PSI: 140
- Temperature: 160° F
- 3/4" FGH Inlet, 3/4" MGH Outlet
- Chemical strainer and 4' PVC tubing included
- Adjustable with ST-61 meter valve
- Locking Waterflow Adjustment

PART NO.	OLD NO.	DESCRIPTION	GPM	PSI
8.710-482.0	360155	ST-64 Up Stream Injector	1.5-4.0	140
8.710-483.0	360156	ST-64 Up Stream Injector	4.0-7.0	140

### CHEMICAL INJECTORS - ROBOKIM



- PSI: 3500
- Temperature: 180° F
- 3/8" MPT Inlet, Outlet
- 1/4" Hose Barb
- Stainless-Steel Orifice
- Stainless-Steel Inlet Check Valve Components

PART NO.	OLD NO.	DESCRIPTION	GPM	PSI
Robokim W/ Plastic Meter Knob				
8.710-497.0	360200	"0", 3/8" MPT inlet / outlet	2.1-2.9	3500
8.710-498.0	360201	"1", 3/8" MPT inlet / outlet	3.0-4.0	3500
8.710-499.0	360202	"2", 3/8" MPT inlet / outlet	4.0-5.5	3500
8.710-500.0	360203	"3", 3/8" MPT inlet / outlet	5.5-10.8	3500
8.704-708.0		Repair Kit, RoboKim		

### CHEMICAL INJECTORS - ROBOKIM QUICK-COUPLED

- Quick-Couplers: 3/8" QC Plug Inlet, 3/8" QC Socket Outlet
- 6" industrial-grade poly-braid reinforced tubing
- AP brass chemical filter with stainless-steel check valve



PART NO.	OLD NO.	DESCRIPTION	GPM
Robokim "QC" W/ Plastic Knob			
8.904-209.0	360210X	"0", 3/8" QC plug inlet / socket outlet	2.1-2.9
8.904-210.0	360211X	"1", 3/8" QC plug inlet / socket outlet	3.0-4.0
8.904-211.0	360212X	"2", 3/8" QC plug inlet / socket outlet	4.0-5.5
8.904-212.0	360213X	"3", 3/8" QC plug inlet / socket outlet	5.5-10.8
Robokim "QC" W/ Brass Knob			
8.904-217.0	360230X	"0", 3/8" QC plug inlet / socket outlet	2.1-2.9
8.904-218.0	360231X	"1", 3/8" QC plug inlet / socket outlet	3.0-4.0
8.904-219.0	360232X	"2", 3/8" QC plug inlet / socket outlet	4.0-5.5
8.904-220.0	360233X	"3", 3/8" QC plug inlet / socket outlet	5.5-10.8

### HI-LO INJECTOR



May be used on high or low side of pump. Adjustable flow orifices plus adjustable chemical valves. Standard features similar to ST-62.



- Performance Range:  
Low Side: PSI: 10-120, GPM: 5-3.5  
High Side: PSI: 3500, GPM: 2.0-8.0
- Machined-Brass Body
- 3/8" FPT Inlet, Outlet

PART NO.	OLD NO.	DESCRIPTION	GPM	PSI
8.710-486.0	360163	Hi / Lo Injector W/Meter Valve	2.0-8.0	3500
8.710-487.0	360165	W/O Chemical Adjust	2.0-8.0	3500
8.700-290.0	075136	Repair Kit		
8.900-044.0	075136X	Seal Kit		

## CHEMICAL INJECTORS - 400 SERIES

The injector of choice.



- PSI: 3200
- Temperature: 200° F
- Forged-Brass Housing
- Teflon® Valve Seat
- 3/8" Inlet, Outlet (3 Configurations)
- Renewable Orifices and Check Valve
- Options Include: Quick-Coupled, Stainless-Steel Orifices, Acid-Resistant Check
- Weight: 5 oz

### Orifice Selection

ORIFICE DIA.	DESCRIPTION	GPM / FLOW RATE	PSI
1.6 mm	3/8" Inlet / Outlet	1.5-2.7	3200
1.8 mm	3/8" Inlet / Outlet	2.0-3.6	3200
2.1 mm	3/8" Inlet / Outlet	2.7-4.9	3200
2.3 mm	3/8" Inlet / Outlet	3.3-6.0	3200

### Adjustable Injectors, Precise Needle-Metering Valve

ORIFICE SIZE	M X M PART NO.	M X M OLD NO.	M X F PART NO.	M X F OLD NO.	F X M PART NO.	F X M OLD NO.
Brass						
1.6	8.710-541.0	360406	8.710-549.0	360416	8.710-559.0	360426
1.8	8.710-535.0	360400	8.710-543.0	360410	8.710-551.0	360420
2.1	8.710-537.0	360401	8.710-545.0	360411	8.710-554.0	360421
2.3	8.710-539.0	360402	8.710-547.0	360412	8.710-557.0	360422
Stainless-steel						
1.6	8.710-542.0	360406S	8.710-550.0	360416S	8.710-560.0	360426S
1.8	8.710-536.0	360400S	8.710-544.0	360410S	8.710-552.0	360420S
2.1	8.710-538.0	360401S	8.710-546.0	360411S	8.710-556.0	360421S
2.3	8.710-540.0	360402S	8.710-548.0	360412S		

PART NO.	OLD NO.	DESCRIPTION
Repair Kits include Check Ball, Spring, Seat and O-ring		
8.900-769.0	109220X	Standard Kit

ORIFICE SIZE	M X M PART NO.	M X M OLD NO.	M X F PART NO.	M X F OLD NO.	F X M PART NO.	F X M OLD NO.
Brass / Acid-Resistant						
1.6	8.904-230.0	360406A	8.904-238.0	360416A	-	-
1.8	8.904-224.0	360400A	8.904-232.0	360410A	-	-
2.1	8.904-226.0	360401A	8.904-234.0	360411A	8.904-242.0	360421A
2.3	8.904-228.0	360402A	8.904-236.0	360412A		

Stainless-steel / Acid-Resistant						
1.6	-	-	8.904-239.0	360416AS	8.904-246.0	360426AS
1.8	8.904-225.0	360400AS	8.904-233.0	360410AS	8.904-241.0	360420AS
2.1	8.904-227.0	360401AS	8.904-235.0	360411AS	8.904-243.0	360421AS
2.3	8.904-229.0	360402AS	8.904-237.0	360412AS	-	-

PART NO.	OLD NO.	DESCRIPTION
Repair Kits include Check Ball, Spring, Seat and O-ring		
8.900-770.0	109222X	Acid Kit

### SERIES 505 STAINLESS-STEEL

All metal parts are stainless-steel



- PSI: 5650
- GPM: 8.0
- Temperature Max: 195°F
- 3/8" Inlet, Outlet
- Premier Type Injector
- Teflon® O-Rings

PART NO.	OLD NO.	DESCRIPTION	GPM	PSI
8.710-586.0	360505 / 1.8	Stainless-steel Injector 1.8	2.0-3.6	5650
8.710-587.0	360505 / 2.1	Stainless-steel Injector 2.1	2.7-4.9	5650
8.710-588.0	360505 / 2.3	Stainless-steel Injector 2.3	3.3-6.0	5650
8.704-027.0	109234	Repair Kit		

### INJECTOR - ADJUSTABLE QUICK-CONNECT



- PSI: 3500
- Temperature Max: 200°F

PART NO.	OLD NO.	DESCRIPTION	GPM	PSI
8.710-502.0	360240	Adjustable QC, 200° F	2.0-3.0	3500
8.710-503.0	360242	Adjustable QC, 200° F	3.0-5.0	3500
8.710-504.0	360244	Adjustable QC, 200° F	5.0-8.0	3500
Acid Injectors				3500
8.904-221.0	360240A	Adjustable QC, 200° F	2.0-3.0	3500
8.904-222.0	360242A	Adjustable QC, 200° F	3.0-5.0	3500
8.904-223.0	360244A	Adjustable QC, 200° F	5.0-8.0	3500
8.701-187.0	080055	Injector Repair Kit		
8.900-087.0	080056	Injector Acid Kit		

### INJECTORS - BRASS

All metal parts are brass



- PSI: 3200
- Temperature Max: 190°F
- 3/8" Inlet, Outlet
- Premier Type Injector

PART NO.	OLD NO.	DESCRIPTION	GPM	PSI
8.710-505.0	360245	Brass Injector 1.8	2.0-3.6	3200
8.710-506.0	360246	Brass Injector 2.1	2.7-4.9	3200
8.710-507.0	360247	Brass Injector 2.3	3.3-6.0	3200
8.704-028.0	109235	Repair Kit		

### PRESSURE REDUCER / INJECTOR - EXTACT-A-FLOW

"Low side" chemical injector that regulates inlet pressure to maintain consistent chemical ratio.



- GPM: Up to 6.0
- 1/2" FPT I/O Ports
- 1/4" Hose Barb Chemical Inlet
- ±2% Injection Ratio Variation

PART NO.	OLD NO.	DESCRIPTION
8.711-162.0	385127	Weep Seat*
8.711-160.0	385125	Non-Weep
8.711-161.0	385126	With Switch**
8.904-389.0	385128	Hose Barb W/ Viton Check
8.904-390.0	385129	Hose Barb W/ Buna Check

\* Weep Seat allows pump to self-prime  
\*\* With burner control switch automatically turns burner off when water flow stops

### ADJUSTABLE BRONZE FLOAT VALVES



- Temperature Max: 180°F
- Cast-Bronze Body
- Adjustable Float Arm
- Live Rubber Stopper

PART NO.	OLD NO.	THREAD	STEM	GPM AT 40 PSI
8.710-045.0	343306	1"	1/4"-20	47

Note: Float valves above require stem and float, below  
Repair parts for adjustable valves

8.700-475.0	076406	Long Arm*
8.700-476.0	076407	Short Arm*
8.700-477.0	076408	Thumb Screw*
8.700-479.0	076418	3/8" and 1/2" Plunger

\*Fits 3/8", 1/2" and 3/4" valve only

### STEMS ONLY



9.802-157.0

8.710-047.0

PART NO.	OLD NO.	LENGTH	MATERIAL	THREAD
9.802-157.0	343310	8"	SS	1/4"-20
8.710-047.0	343310C	8"	Brass	1/4"-20 x 5/16"-18
8.710-051.0	343315	10"	SS	1/4"-20

Parts for other float valves also available



### COPPER AND PLASTIC FLOAT BALLS



8.710-053.0



9.802-061.0

PART NO.	OLD NO.	LENGTH	MATERIAL	THREAD
8.710-061.0	343326	4" x 5"	Copper	1/4"-20
8.710-052.0	343317	5"	Copper	1/4"-20
8.710-053.0	343318	6"	Copper	1/4"-20
Plastic				
8.710-057.0	343321	6"	Plastic	1/4"-20
8.710-059.0	343323	8"	Plastic	1/4"-20
9.802-061.0	343325	4" x 5"	Plastic	1/4"-20

Parts for other float valves also available

### PA FLOAT VALVE



- GPM: 7.0 at PSI: 30
- GPM: 5.0 at PSI: 15
- Temperature: 140° F
- 3/8" BSP Inlet
- Brass Body
- Positional / Adjustable Arm

PART NO.	OLD NO.	DESCRIPTION	MATERIAL	TEMP
8.710-042.0	343301	3/8" Float Valve	Brass Body	140° F
8.704-204.0	110250	Repair Kit		

### BRASS FLOAT VALVE ASSEMBLY



Complete assembly includes valve, stem and float



- GPM: 4.5
- Temperature: 175°F
- 1/2" FPT Inlet
- Brass Housing with Polyamide Cover

PART NO.	OLD NO.	DESCRIPTION	GPM	TEMP
8.710-031.0	343010	ST-8	4.5	175° F

MPT Adapter Kit for ST-8\*

8.710-033.0 343012  
\*Double MPT nipple, sealing washer and lock nut

### BRASS FLOAT, BALL AND STEM



- Inlet PSI Max: 142
- GPM: 7.1 at PSI: 28
- 1/2" MPT Inlet
- Temperature: 140°F
- Positive Soft Buna / Brass Shut-Off
- Adjustable Float Ball Settings
- Inlet Nut and Washer Seal Provided

PART NO.	OLD NO.	DESCRIPTION	PSI MAX	TEMP
8.710-037.0	343050	Valve Complete	142	140° F
8.704-092.0	109502	Repair Kit		

Specifications, product descriptions and product availability subject to change without notice.

### DIAPHRAGM FLOAT VALVE



- PSI: 142
- GPM: 7.86 at PSI: 28
- GPM: 6.68 at PSI: 14
- Temperature: 140° F
- 3/8" MPT Inlet
- Requires only 6.5" x 3" inside tank
- All-Plastic Snap-On Float
- Positive Shutoff Diaphragm Style
- Inlet Screen, Tank Gasket and Nut Included

PART NO.	OLD NO.	DESCRIPTION	PSI	TEMP
8.710-030.0	343007	Float Valve Complete	142	140° F

### VERTICAL FLOAT TANK VALVE



- GPM: 9.0 at PSI: 150
- Temperature: 140° F
- 1/2" MPT Inlet
- Inlet Nut and Washer Seal Provided

PART NO.	DESCRIPTION	TEMP
9.802-185.0	Vertical Float Tank Valve, 1/2" MPT Inlet	140° F

### HUDSON FLOAT VALVE



- PSI: 0-130
- Temperature: 90° F
- No external moving parts
- No Float Ball or Arm
- All Plastic, Nylon, Rubber and Stainless-Steel
- 1" Inlet - Easy Installation
- Automatic Anti-Siphon
- Flow Capacity 80% of Supply: GPM:40 at PSI: 40

PART NO.	OLD NO.	DESCRIPTION	PSI	TEMP
8.710-035.0	343022	1" Hudson Float Valve, 90°	0-130	90° F
8.710-036.0	343026	1" Hudson Float Valve, 150°	0-130	90° F

### KERICK FLOAT VALVE



#### Flow Rate for 1/2" Valve

- PSI: 20 at GPM: 7.7
- PSI: 30 at GPM: 9.1
- PSI: 40 at GPM: 10.5
- PSI: 50 at GPM: 11.4
- PSI: 60 at GPM: 12.5

#### Flow Rate for 3/4" Valve

- PSI: 30 at GPM: 13
- PSI: 60 at GPM: 16.5

PART NO.	DESCRIPTION	ORIFICE
8.749-328.0	1/2" Float Valve	.25"
8.749-329.0	3/4" Float Valve	.30"

### CHECK VALVES - SWING ACTION

Retain prime on pumps with low-lift capability



- PSI: 150
- Brass Body, Swing (flapper) action
- FPT Inlet, Outlet
- Gravity Seal, No Spring Pressure

PART NO.	OLD NO.	DESCRIPTION	PSI
8.709-378.0	310862	1/2", FPT Inlet / Outlet, Gravity Seal	150
8.709-379.0	310863	3/4", FPT Inlet / Outlet, Gravity Seal	150
8.709-380.0	310864	1", FPT Inlet / Outlet, Gravity Seal	150
8.709-381.0	310865	1-1/4", FPT Inlet / Outlet, Gravity Seal	150

### STAINLESS-STEEL CHECK VALVES



- PSI: 6500
- Rated PSI: 5800
- Temperature: 195° F
- Female x Female
- Weight: 2.0 oz

PART NO.	OLD NO.	DESCRIPTION	FLOW RATE	PSI
8.709-361.0	310827	1/4" F x F	6.1	6500
8.709-362.0	310828	3/8" F x F	10.5	6500

### HIGH-PRESSURE CHECK VALVES



8.709-356.0

8.709-357.0

8.709-358.0

- PSI: 2500 or 3000 Ball Check
- Cracking Pressure PSI: 1
- Buna Seals
- Stainless-Steel Check Ball
- Machined-Brass Body

PART NO.	OLD NO.	DESCRIPTION	MATERIAL
2500 PSI Miniature Ball Check			
8.709-356.0	310814	1/4", M x F	Machined Brass Body
8.709-357.0	310815	1/4", M x M	Machined Brass Body
3000 PSI Stainless Guided Ball and Quad Ring Seat			
8.709-358.0	310820	1/4", F x F	Machined Brass Body
8.709-359.0	310822	3/8", F x F	Machined Brass Body

### CHECK VALVES



- PSI: 1200
- Cracking Pressure PSI: 1
- Machined-Brass Body
- Poppet Seal

PART NO.	OLD NO.	DESCRIPTION	MATERIAL
8.709-351.0	310804	1/4", F x F	Machined Brass Body
8.709-352.0	310806	3/8", F x F	Machined Brass Body
8.709-353.0	310808	1/2", F x F	Machined Brass Body
8.709-354.0	310811	3/4", M x M	Machined Brass Body

### BRASS CHECK VALVES - SPRING LOADED

Holds pump prime without overloading pump suction



- PSI: 150
- Temperature: 250° F
- Machine-Cast Brass Bodies
- FPT x FPT
- Mount Horizontal or Vertical

PART NO.	OLD NO.	DESCRIPTION	PSI	TEMP
8.709-384.0	310872	1/2"	150	250° F
8.709-385.0	310873	3/4"	150	250° F
8.709-386.0	310874	1"	150	250° F

### BACKFLOW PREVENTOR - CHECK VALVE

Protects water supply from harmful chemical backflow - will not allow "spike" pressure to push chemicals into supply line. Now required by many city and state regulations.



- Machined-Brass Housing
- Plastic Diaphragm Check
- 3/4" Female Garden Hose Inlet (with Lock Screw)
- 3/4" Male Garden Hose Outlet

PART NO.	OLD NO.	DESCRIPTION	MATERIAL
8.705-039.0	140060	Backflow Preventor	Machined Brass Housing

### PVC CHECK VALVE

Holds pump prime without overloading pump suction.



- PSI: 125
- Cracking Pressure PSI: 1
- Temperature: 180° F
- Choice of Connects
- PVC Plastic Body
- Stainless-Steel Ball Check
- Designed for Harsh Chemical Applications

PART NO.	OLD NO.	DESCRIPTION	PSI	TEMP
8.709-366.0	310834	1/4" MPT x 1/4" Barb	125	180° F
8.709-367.0	310835	1/4" Barb x 1/4" MPT	125	180° F
8.709-369.0	310837	1/4" Barb x 1/4" Barb	125	180° F
8.709-370.0	310838	3/8" Barb x 3/8" Barb	125	180° F
8.709-373.0	310844*	1/2" Barb x 1/2" Barb	125	180° F

\*8.709-373.0 has Viton Seals

**BALL VALVES - STAINLESS-STEEL**



- PSI: 2000 at Temperature: 180° F
- PSI: 1000 at Temperature: 300° F
- PSI: 300 at Temperature: 350° F
- Full-Flow Ports
- Investment Cast Process
- Two-Piece 316 Stainless Bodies
- Glass-Filled Teflon® Seals

PART NO.	OLD NO.	DESCRIPTION
8.709-265.0	306534	1/4" F x F, Glass-filled Teflon® Seals
8.709-266.0	306536	3/8" F x F, Glass-filled Teflon® Seals
8.709-268.0	306538	1/2" F x F, Glass-filled Teflon® Seals
8.709-269.0	306540	3/4" F x F, Glass-filled Teflon® Seals

**BALL VALVES - FORGED-BRASS**



- PSI: 600
- Temperature: 180° F
- Forged-Brass Body
- Full-Flow Ports
- Teflon® PTFE Seals

M X F PART NO.	F X F PART NO.	M X M PART NO.	SIZE
8.709-249.0	8.709-250.0		1/4"
8.709-252.0	8.709-253.0	8.709-254.0	3/8"
8.709-255.0	8.709-256.0	8.709-257.0	1/2"
8.709-258.0	8.709-259.0	8.709-260.0	3/4"
8.709-261.0	8.709-262.0	8.709-263.0	1"

**BALL VALVES - NICKEL-PLATED BRASS**



- Threaded FPT Connects
- Chrome-Plated Ball
- Full-Flow Bore
- Seats and Seals have Glass-Filled Teflon®

PART NO.	OLD NO.	DESCRIPTION	PSI
8.709-242.0	306504	1/4", Chrome-plated Ball, Full-flow Bore	710
8.709-243.0	306506	3/8", Chrome-plated Ball, Full-flow Bore	710
8.709-244.0	306508	1/2", Chrome-plated Ball, Full-flow Bore	710
8.709-245.0	306512	3/4", Chrome-plated Ball, Full-flow Bore	570
8.709-246.0	306516	1", Chrome-plated Ball, Full-flow Bore	570
8.709-247.0	306520	1-1/4", Chrome-plated Ball, Full-flow Bore	430
8.709-248.0	306524	1-1/2", Chrome-plated Ball, Full-flow Bore	430
8.709-264.0	306532	2", Chrome-plated Ball, Full-flow Bore	360

**MINI BALL VALVES**



- PSI: 600
- 180° Handle Movement
- Forged-Brass Body

M X F PART NO.	F X F PART NO.	M X M PART NO.	SIZE
8.709-208.0	8.709-209.0	-	1/8"
8.709-211.0	8.709-212.0	8.709-213.0	1/4"
8.709-216.0			3/8"

**BALL VALVES - HIGH-PRESSURE**



- Rugged Carbon Steel Construction
- 2-Way
- NPT (F x F) Threads
- Blow-Out Proof Stems
- Delrin Ball Seats
- Viton O-Rings

PART NO.	OLD NO.	FPT	PSI
8.709-274.0	306552	1/4" x 1/4"	7350
8.709-276.0	306553	3/8" x 3/8"	7350
8.709-279.0	306554	1/2" x 1/2"	7350
8.709-282.0	306556	3/4" x 3/4"	5880
8.700-270.0	075080	Replacement handle - fits all sizes above	
8.700-271.0	075089	Replacement screw for handle	

**BALL VALVES, STAINLESS-STEEL, HIGH-PRESSURE**



- PSI: 5800
- 316 Stainless-Steel Body, Ball and Stem
- Viton O-Rings
- Delron Ball Seats
- Full Port

PART NO.	OLD NO.	FPT	PSI
8.709-277.0	306553S	3/8" x 3/8"	5880
8.709-280.0	306554S	1/2" x 1/2"	5880
8.709-283.0	306556S	3/4" x 3/4"	5880
8.709-286.0	306558S	1" x 1"	5880

**BALL VALVES - STAINLESS-STEEL, ONE-PIECE**



- PSI: 800 at Temperature: 300° F
- PSI: 400 at Temperature: 350° F
- Standard Port
- 316 Stainless-Steel Body
- Suitable for Steam

PART NO.	OLD NO.	FPT	MATERIAL
8.709-287.0	306582	1/4" x 1/4"	316 Stainless-steel Body
8.709-288.0	306583	3/8" x 3/8"	316 Stainless-steel Body
8.709-290.0	306585	3/4" x 3/4"	316 Stainless-steel Body

**BALL VALVES - BRASS MINI**



- PSI: 220 Working Pressure
- Brass Housing-Hex Bar
- Compact Knob Operation
- Designed to fit tight quarters
- Teflon® Seals

PART NO.	OLD NO.	FPT	PSI
8.709-270.0	306542	1/8" x 1/8"	220 working pressure
8.709-271.0	306544	1/4" x 1/4"	220 working pressure
8.709-272.0	306546	3/8" x 3/8"	220 working pressure
8.709-273.0	306548	1/2" x 1/2"	220 working pressure

### BALL VALVES - PVC

Great for chemical on / off flow control.



- PSI: 125
- Temperature: 180° F
- Flag Handle
- PVC and Nitrile Material
- Chemical and Impact Resistant

PART NO.	OLD NO.	DESCRIPTION	PSI
8.709-214.0	306352P	1/4" Panel Mtg, Barb x Barb	125
8.709-219.0	306354P	1/4" In-line, Barb x Barb	125
8.709-220.0	306356	3/8" In-line, Barb x Barb	125

### BALL VALVES - COMPACT PVC



- PSI: 150 Working Pressure
- Temperature: 150° F
- FPT Thread Both Ends
- Easy-Turn Handle
- EPDM Seals - White Body

PART NO.	OLD NO.	FPT	PSI
8.709-233.0	306444	1/4" x 1/4"	150
8.709-234.0	306448	1/2" x 1/2"	150
8.709-235.0	306450	3/4" x 3/4"	150
8.709-236.0	306452	1" x 1"	150
8.709-237.0	306454	1-1/4" x 1-1/4"	150
8.709-238.0	306456	1-1/2" x 1-1/2"	150
8.709-239.0	306460	2" x 2"	150

### BALL VALVES - BRASS



- PSI: 3000

PART NO.	DESCRIPTION	PSI
8.753-959.0	3/8" F x F, BSPF x BBPP, Ball Valve Brass	3000

### BALL VALVE - 3 WAY



- PSI Max: 400
- Temperature Max: 180° F
- Telfon® Seat
- Buna Seals
- Brass

PART NO.	OLD NO.	DESCRIPTION	PSI	TEMP
8.709-207.0	306331	1/4" M x F x F	400	180° F

### BALL VALVES - POLYPROPYLENE

Full port reinforced polypropylene.



8.709-222.0      8.709-228.0

- PSI: 150 Working Pressure
- Easy Turn with Telfon® Seals
- Double seal in stem for "no leak"
- Threaded Mounting Bosses, Brass Insert on 1-1/4" - 2" Sizes

PART NO.	OLD NO.	FPT	PSI
<b>Two-Way Ball Valves</b>			
8.709-222.0	306390	1/2" x 1/2"	150
8.709-223.0	306392	3/4" x 3/4"	150
8.709-224.0	306394	1" x 1"	150
8.709-225.0	306398	1-1/2" x 1-1/2"	150
8.709-226.0	306400	2" x 2"	150

PART NO.	OLD NO.	FPT	PSI
<b>Three-Way Ball Valves</b>			
8.709-227.0	306408	1/2" x 1/2" x 1/2"	150
8.709-228.0	306412	3/4" x 3/4" x 3/4"	150
8.709-229.0	306416	1" x 1" x 1"	150
8.709-230.0	306420	1-1/4" x 1-1/4" x 1-1/4"	150
8.709-231.0	306422	1-1/2" x 1-1/2" x 1-1/2"	150
8.709-232.0	306424	2" x 2" x 2"	150

### FLOW SELECTOR VALVE

3-way and 4-way lever control with brass body.



- 3-Way
- Plumb for 2 Inlets and 1 Outlet or 1 Inlet and 2 Outlets
- 4-Way
- Plumb for 3 Inlets and 1 Outlet or 1 Inlet and 3 Outlets
- Rated Temperature: 180° F

PART NO.	OLD NO.	DESCRIPTION	TEMP
8.710-108.0	343734	1/4" FPT 3-Way	180° F
8.710-110.0	343736	3/8" FPT 3-Way	180° F
8.710-113.0	343744	1/4" FPT 4-Way	180° F
8.710-114.0	343746	3/8" FPT 4-Way	180° F

### FLOW CONTROL METERING VALVE



- PSI: 300
- Rated Temperature: 175° F
- Forged-Brass, Nickel-Plated Body
- Panel Mtg in 17/32" Hole
- Compact Size
- Double-Stem Seal

PART NO.	OLD NO.	DESCRIPTION	TEMP	PSI
8.710-775.0	371125	1/4", FPT Inlet / Outlet	175° F	300
8.710-776.0	371133	3/8", FPT Inlet / Outlet	175° F	300

## FLOW CONTROL METERING VALVE

The valve that "seals" (will not suck air).



- PSI: 3500
- Rated Temperature: 195° F
- 28" Vacuum - No Leak
- Viton gland seal isolates metering threads from solution
- Stainless-Steel Needle, Brass Seat
- 1/4" FPT Ports
- Heavy-Duty Brass Bar Stock Body
- Panel Mounts 5/8" Hole
- Large Easy-Grip Four-Lobe Handwheel
- Aluminum or Poly Available

PART NO.	OLD NO.	DESCRIPTION	PSI
8.904-362.0	371120X	Metering Valve, Aluminum Knob	3500
8.904-361.0	371120P	Metering Valve, Poly Knob	3500
8.740-083.0	077003A	Replacement Knob	

## METERING VALVE - BRASS



- PSI: 450
- Rated Temperature: 170° F
- 1/4" Inlet, Outlet
- Easy-Grip, Fluted Plastic Handle with Pointer
- Brass Body, Viton gland seal eliminates air leaks
- Panel Mount 11/16" or 3/4" Hole
- Extremely Compact T-Style

PART NO.	OLD NO.	DESCRIPTION	PSI
8.710-773.0	371115	"T" 1/4" F x F, Forged	450
8.710-774.0	371116	"L" 1/4" M x M, Machined	450
9.802-188.0		"L" 1/4" M x M	450

## CHEMICAL METERING VALVES



9.802-187.0

- PSI: 4000
- GPM: 6
- 1/4" Inlet, Outlet
- Adjusts from off to full flow
- 9.802-187.0 has presettable limiting orifice

PART NO.	OLD NO.	DESCRIPTION	PSI
8.710-771.0	727628	Flow Control	4000
9.802-187.0	2-30151	Flow Control W/ Locking Adjustment	4000
9.802-532.0		Valve, Less Solenoid	4000

## CHEMICAL METERING ON-OFF VALVE



- Single 12" Hole Panel Mounting
- Brass and Stainless-Steel Materials
- Dual-knob control - calibrate chemical flow with base knob. Outside knob allows on / off control without changing calibration

PART NO.	OLD NO.	DESCRIPTION	PANEL MOUNTING
8.710-770.0	371100	MV-100	Single 1/2" Hole

## CHEMICAL METER AND SELECTION VALVE - ST-66



- Double-Metering Dial with Center OFF
- Panel Mount in Single 5/8" Hole
- Two input barbs - for different chemicals to single outlet barb

PART NO.	OLD NO.	DESCRIPTION	PANEL MOUNTING
8.710-779.0	371166	ST-66	Single 5/8" Hole

## STEAM VALVE

For "combo" hot pressure washer / steamer units. The single-turn on / off diverter valve bypasses pump flow to reduce water flow to the coil, creating steam in place of normal hot water.



- PSI: 3600
- Temperature: 175° F
- 1/4" MPT Inlet, Outlet
- Panel Mount in 11/16" or 3/4" Hole
- Machined-Brass Body
- Easy-Grip Plastic Knob

PART NO.	OLD NO.	ORIFICE (MM)	PSI	TEMP
8.711-263.0	400008	0.8	3600	175° F
8.904-406.0	400012	1.2	3600	175° F
8.904-407.0	400015	1.5	3600	175° F
8.904-408.0	400018	1.8	3600	175° F
8.904-409.0	400020	2.0	3600	175° F

## THERMAL RELIEF VALVES

A must for any pump that might ever be left in bypass mode (unloading) for more than 15 seconds. Protects the pump from overheating caused by recirculating water.



- Installs in Bypass Line
- Automotive Style Wax Element
- Automatically resets at cool down to 115° + F
- No Adjustment Required
- 1/8" FPT Side Discharge
- PSI: 125 Inlet Pressure
- GPM: 2.5

PART NO.	OLD NO.	INLET	GPM	"TRIP" TEMP
8.904-565.0	458001	3/8" MPT	2.5	140° F
8.904-566.0	458005	1/2" MPT	2.5	140° F
8.723-943.0	458007	1/2" MPT	2.5	165° F



**COMPACT THERMAL RELIEF VALVES**



- Temperature: 145° F
- "Trip" Temperature: 190° F

PART NO.	OLD NO.	SIZE	"TRIP" TEMP
8.712-544.0	458024	1/4" MPT	145° F
8.712-545.0	458026	3/8" MPT	145° F
9.802-181.0	921421	3/8" MPT	145° F
9.804-025.0		1/4" MPT	145° F
8.707-250.0		3/8" MPT	190° F
9.803-670.0		1/2" MPT	190° F

**TRV THERMAL RELIEF VALVES**



- PSI: 145
- Opens Temperature: 145° F
- Low Profile
- Brass Body
- Plastic-Covered Barb

PART NO.	OLD NO.	DESCRIPTION	PSI
8.712-547.0	458032	3/8" Inlet Inlet, Low Profile, Brass Body	145
8.712-548.0	458034	1/2" Inlet, Low Profile, Brass Body	145

**FLOW METERS**

The answer to precision calibration and efficient operation of pressure washing systems.



- PSI: 100
- Temperature: 150° F
- 1/8" FPT Inlet, Outlet Port
- Accurate within ± 5%
- Precision-Cut and Machined-Clear Acrylic
- Metal mounting inserts for ease of installation (10-32 threads)
- Wetted parts are brass or stainless-steel with or without metering valves
- Compact Size - 2" Tall Scale, 4-3/32" Overall Height
- Flow Scale Measures Gallons Per Hour (GPH)

PART NO.	OLD NO.	GPH	MATERIAL	METERING VALVE
8.710-097.0	343722	.6-5	Brass	No
8.710-098.0	343723	.6-5	Brass	Yes
8.710-101.0	343726	2-10	Brass	No
8.710-102.0	343727	2-10	Brass	Yes
8.710-099.0	343724	.6-5	Stainless-steel	No
8.710-100.0	343725	.6-5	Stainless-steel	Yes
8.710-104.0	343728	2-10	Stainless-steel	No
8.710-105.0	343729	2-10	Stainless-steel	Yes

Note: All flow measurements must be on low-pressure side of pump

**RUPTURE DISKS**



- Prevents dangerous thermal expansion of water in the coil
- Ensures operator safety

PART NO.	OLD NO.	DESCRIPTION	PSI
9.802-192.0	2-3409	Assembly	7000
8.707-381.0		Assembly	8500

**THERMAL RELIEF VALVES**



- Machined Brass
- Automatically Resets
- Prevents pressure overloads, protecting people and equipment

PART NO.	OLD NO.	DESCRIPTION	MAX PSI
8.722-192.0	G022550A	1/4", Silver Spring	1200
8.722-193.0	G022560A	1/4", Red Spring	2400
8.722-194.0	G022565A	1/4", Orange Spring	3600
8.722-190.0	G022532A	3/8", Orange Spring	3600
9.802-191.0	G022533A	3/8", Blue Spring	5000

**AIR VALVE - COIL BLOW OUT**



Install in-line in front of coil and use air pressure to blow water out of coil to prevent "freeze-up".



- Threaded Connection
- 1/8" Model is Stainless-Steel
- 1/4" Brass Valve
- Valve Cap Included

PART NO.	OLD NO.	DESCRIPTION
8.705-047.0	140073	1/8" Stainless-steel Connect
8.705-048.0	140075	1/4" Connect
8.902-426.0		Valve Assy, Water Blow-Out
8.707-314.0		Valve Assy, Water Tank Blow-Out

**EASY-START VALVE**



- Temperature: 200° F
- GPM: 8.0
- 1/8" FPT Outlet
- Machined-Brass Housing
- Hose Barb Outlet
- Stainless-Steel Internal

PART NO.	OLD NO.	DESCRIPTION	INLET / OUTLET	PSI
9.804-065.0		Easy-Start Valve	1/4" MPT, 1/8" FPT	5000
9.802-190.0		Easy-Start Valve	3/8" MPT, 1/8" FPT	5000
8.709-865.0	339004	Easy-Start Valve	3/8" MPT, 1/8" FPT	4100
8.709-866.0	339005	Easy-Start Valve	3/8" MPT, 1/8" Outlet	3500
8.751-265.0		Valve, 5/16" HP Outlet		5000
9.802-137.0	140352	Hose Barb, 1/8" x 1/4" Barb		

### EASY-START VALVE



- PSI: 3200
- Temperature: 176° F
- GPM: 7.8
- 3/8" MPT Inlet
- Hose Barb Outlet (8 mm)
- Machined-Brass Body
- Stainless-Steel Spring and Ball

PART NO.	OLD NO.	DESCRIPTION	GPM	PSI
8.709-867.0	339006	Easy-Start Valve	7.8	3200

### STEEL UTILITY GAUGES



- Black Lacquered Steel Case
- Bronze Bourdon Tube
- Dry Gauge
- 1/4" NPT Brass Mounting Stem
- Accuracy ± 3-2-3%

PART NO.	OLD NO.	PRESSURE RANGE	MOUNTING STEM
2" Bottom Mount			
8.710-307.0	348552	0-60	1/4" NPT Brass
8.710-308.0	348554	0-100	1/4" NPT Brass
8.710-309.0	348558	0-200	1/4" NPT Brass
8.710-310.0	348560	0-300	1/4" NPT Brass

### FUEL OIL PRESSURE GAUGE



- PSI: 0-2000
- Perfect for testing burner pump fuel pressure

PART NO.	OLD NO.	DESCRIPTION	PRESSURE RANGE
8.700-738.0	079020	Fuel Oil Pressure Gauge	0-200 PSI

### CORROSION-RESISTANT ABS GAUGE



- Acid and Alkali Proof Plastic Case
- 1/4" NPT Brass Mounting Stem
- Accuracy, Dry: ± 3-2-3%
- Accuracy, Filled: ± 1.5%
- Bronze Bourdon Tube

PART NO.	OLD NO.	PRESSURE RANGE	MOUNTING STEM
8.710-291.0	348305	0-100 PSI	1/4" NPT Brass
8.710-293.0	348307	0-200 PSI	1/4" NPT Brass
8.710-294.0	348308	0-300 PSI	1/4" NPT Brass
8.710-295.0	348312	0-1000 PSI	1/4" NPT Brass
8.710-296.0	348313	0-2000 PSI	1/4" NPT Brass
8.710-297.0	348314	0-3000 PSI	1/4" NPT Brass
8.710-299.0	348316	0-5000 PSI	1/4" NPT Brass

### PRESSURE GAUGES



- PSI: 5000 Cold Water
- 1-3/4" Gauge
- 3/8" QC Socket
- 3/8" QC Plug

PART NO.	DESCRIPTION	QC SOCKET / PLUG
8.712-208.0	Pressure Gauge Kit, 5000 PSI Cold Water	3/8", 3/8"

### PRESSURE REGULATOR

- PSI: 10-125
- Lowers city water pressure for better machine performance

PART NO.	OLD NO.	DESCRIPTION	PSI
8.707-248.0	971443	Pressure Regulator	10-125

### STAINLESS-STEEL PRESSURE GAUGES



- AISI 304 Stainless-Steel Case
- Bronze Bourdon Tube
- 99.5% Pure Glycerin Filled
- PSI and Bar Dual Scale
- 1/4" NPT Brass Mounting Stem
- Convex magnifying lens for easy readings
- Steel Needle and Peg
- Accuracy ± 1.5%

PART NO.	OLD NO.	PRESSURE RANGE	MOUNTING STEM
2-1/2" Bottom Mount with Bronze Internals			
8.710-270.0	348216	0-100 PSI	1/4" NPT Brass
8.710-272.0	348220	0-200 PSI	1/4" NPT Brass
8.710-273.0	348224	0-300 PSI	1/4" NPT Brass
8.710-276.0	348230	0-500 PSI	1/4" NPT Brass
8.710-278.0	348240	0-1000 PSI	1/4" NPT Brass
8.710-280.0	348245	0-2000 PSI	1/4" NPT Brass
8.710-281.0	348250	0-3000 PSI	1/4" NPT Brass
8.710-283.0	348255	0-4000 PSI	1/4" NPT Brass
9.804-017.0	348260	0-5000 PSI	1/4" NPT Brass
8.710-286.0	348262	0-6000 PSI	1/4" NPT Brass
9.804-001.0	348265	0-10,000 PSI	1/4" NPT Brass
2-1/2" Back Mount with Bronze Internals			
8.710-250.0	348140	0-100 PSI	1/4" NPT Brass
8.710-254.0	348150	0-500 PSI	1/4" NPT Brass
8.710-256.0	348152	0-1000 PSI	1/4" NPT Brass
8.710-257.0	348154	0-2000 PSI	1/4" NPT Brass
8.710-258.0	348156	0-3000 PSI	1/4" NPT Brass
8.710-259.0	348158	0-4000 PSI	1/4" NPT Brass
8.712-149.0		0-5000 PSI	1/4" NPT Brass
8.712-150.0		0-6000 PSI	1/4" NPT Brass
8.710-262.0	348162	0-6000 PSI	1/4" NPT Brass
9.804-013.0	348165	0-10,000 PSI	1/4" NPT Brass
Mounting Hardware for Back Mount Gauges			
8.710-223.0	348001		1/4" NPT Brass
8.710-228.0	348090		1/4" NPT Brass

**STAINLESS-STEEL PRESSURE GAUGES**



- Black Lacquered Steel Case
- Bronze Bourdon Tube
- Dry Gauge
- 1/4" NPT Brass Mounting Stem
- Accuracy ± 3-2-3%

PART NO.	OLD NO.	PRESSURE RANGE
2-1/2" Back Mount with Bronze Internals		
8.710-246.0	348125	30Hg - 0 Vacuum Gauge
Mounting Hardware for Back Mount Gauges		
8.710-223.0	348001	U-Bracket
8.710-228.0	348090	3-Hole Flange, Mounted

**PRESSURE AND TEMPERATURE TEST SET**



Convenient test set provides both pressure and temperature check with one easy quick coupled connection at outlet of unloader or coil.



- Test Set 5000, 500° F Thermometer 5000 PSI Pressure Gauge for Systems up to 2000 PSI
- Test Set 10,000, 10,000 PSI Pressure Gauge for Systems up to 5000 PSI

PART NO.	OLD NO.	DESCRIPTION
8.904-559.0	449045	Test Set 5000 (0-2500 PSI Systems)
8.904-558.0	449040	Test Set 10,000 (0-5000 PSI Systems)

**SPEEDMASTER THROTTLE CONTROL**



Stop overworking the engine and pump during bypass. Decelerator reduces engine speed when pump head pressure drops below 215 PSI, reduces flow during bypass, slows recirculation heat build-up.



- PSI: 3500
- Temperature: 300° F
- A major system saver for gas engine units
- Machined-Brass Body
- Stainless-Steel Gland Components
- 1/4" Male Connect
- Viton Seals
- 42" Lined and Covered Control Cable
- Engine speeds infinitely adjustable for "fine tuned" system performance

PART NO.	OLD NO.	DESCRIPTION
8.903-840.0	339000A	Throttle Control

**TEMPERATURE GAUGES**



Dial thermometers.



- 3" Diameter Dial - Stainless-Steel Case
- Shatter-Resistant Polycarbonate Lens
- Stainless-Steel Stem (2.5")
- 1/2" MPT Connector
- Accuracy to within 3% of dial range (50-500± 6.8° F)

PART NO.	OLD NO.	DESCRIPTION
8.712-488.0*	426410	Temp Gauge +50° to 500° F
**"Thermowell" to be used with dial thermometers in systems over 300 PSI. For best results, fill Thermowell with liquid silicon or glycol to increase sensitivity and accuracy of readings.		

**THERMOWELL FOR TEMPERATURE GAUGE ABOVE**

- PSI: 2000 Collapse Protection
- Stainless-Steel, 3/4" MPT x 1/2" FPT
- 1.75" Immersion Length

PART NO.	OLD NO.	DESCRIPTION
8.712-489.0	426423	Thermowell for 8.712-488.0

**VOLTMETERS**



- Designated for OEM or Replacement
- Accuracy to ± 5%
- Metal Case
- Rugged and Weather-Resistant
- Bright Stainless Bezel
- Utilize as constant monitor or as test instruments
- Fits 2-1/16" Mounting Hole

PART NO.	OLD NO.	DESCRIPTION
8.712-159.0		Voltmeter 120V

**HOUR METERS FOR GASOLINE ENGINES**



- Elapsed Time
- No Battery Required
- Digital Quartz Accuracy (± .02%)
- Extremely Rugged and Tamperproof
- Sealed from Dirt and Moisture
- Requires 2" Panel Cutout

PART NO.	DESCRIPTION
8.749-183.0	EL 5-80V AC/DC 50/60 Hz
8.749-316.0	EL 24-277 AC/DC 50/60 Hz
9.802-283.0	115/240V AC - Rectangle
8.904-540.0	Tach/Hour 12V DC W/Magnet Tool

**BRIGGS & STRATTON ENGINES - GASOLINE**



Briggs & Stratton's top-of-the-line engines have proven performance in the pressure washer industry. They contain the power to complete any job faster and easier with less wear and tear on major engine components.

- Easy, Quick-Starting
- Large Fuel Tank
- Super Quiet Muffler
- OilGaurd® Low-Oil Shutdown

PART NO.	OLD NO.	HP	SHAFT DIA	START	CHARGE RATE	FUEL TANK	MODEL NO.
8.754-819.0	-	18	1"	Electric	20 Amp	N/A	Vanguard
8.715-067.0	5-0316	21	1"	Electric	N/A	N/A	Vanguard

Note: Mufflers for the above engine are sold separately. See Briggs & Stratton Engine Parts section below.



OHV Vanguard

- State-of-the-Art Carburetion System
- 30% quieter muffler than competition
- Cast / Sintered Iron Sleeve
- OilGaurd® Low-Oil Shutdown

PART NO.	OLD NO.	HP	SHAFT DIA	START	CHARGE RATE	FUEL TANK	MODEL NO.
8.709-887.0	5-0313	11	1"	Recoil	N/A	2 Gal	Vanguard

**BRIGGS & STRATTON ENGINE PARTS**

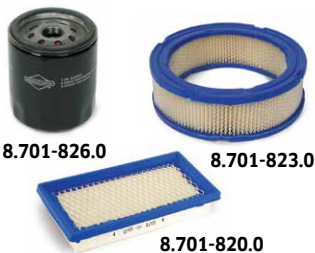

Genuine Briggs & Stratton replacement parts are available. Please provide engine model / type / code to ensure proper fit of replacement parts. All are authorized manufacturer replacement parts.

PART NO.	OLD NO.	DESCRIPTION
8.701-826.0	091960	Briggs 16/18 HP Vanguard, Oil Filter
8.701-820.0	091950	Briggs 5 HP Industrial, Air Filter
8.701-821.0	091952	Briggs 8 or 11 HP IC, Air Filter
8.701-823.0	091954	Briggs 16/18 HP Vanguard, Air Filter
8.718-021.0		Sparkplug, Vanguard, RC12YC

**HONDA ENGINE PARTS**



Original Honda replacement parts from the factory. Filters are a great add-on to every service order. All are authorized manufacturer replacement parts.

PART NO.	OLD NO.	DESCRIPTION
8.701-830.0	091970	Honda 18/20 HP, Oil Filter
8.701-764.0	091746	Honda GX160, Air Filter
8.701-780.0	091775	Honda GX240/270, Air Filter
8.701-781.0	091777	Honda GX340, Air Filter
8.701-782.0	091779	Honda GX610/620, Air Filter (old style)
8.701-783.0	091779A	Honda GX610/620, Air Filter (new style)
8.718-117.0		Honda GX All, Sparkplug

**ENGINES - KOHLER LOMBARDINI - DIESEL**



Kohler Lombardini water cooled diesel engines provide superior power and quiet operation.

- Diesel Powered
- Water Cooled

PART NO.	OLD NO.	HP	SHAFT DIA	START	CHARGE RATE	FUEL TANK	MODEL NO.
9.802-327.0	5-0407	27	1-1/2"	Electric	N/A	No	LDW1003, Water Cooled

**ENGINE PARTS - KOHLER LOMBARDINI**



Factory direct Kohler parts. All are authorized manufacturer replacement parts.

PART NO.	OLD NO.	DESCRIPTION	ENGINE MODEL
8.717-912.0	74-2175107	Oil Filter	LDW602/903/1003
8.717-915.0	74-2175164	Air Filter	LDW602/903/10003
8.717-909.0	74-2175045	Fuel Filter	LDW602/903/1003

**STARTER SOLENOID - 12V DC**

Universal type used on many lawn and garden tractors and mowers.



- Double Terminal - 5/16", 24 Studs
- Same as used on 16 HP B & S Vanguard Engines
- Rated for Intermittent Duty (i.e. for starting small gasoline engines)

PART NO.	OLD NO.	DESCRIPTION
8.701-691.0	091357	12V DC Starter

**VOLTAGE REGULATOR - HEAVY-DUTY 15V**



- Eliminates need for battery on 12 volt recoil hot water washers

PART NO.	OLD NO.	DESCRIPTION
9.802-531.0	860273	Regulator, Voltage 15 Volts

**KEYED IGNITION SWITCH - 12V DC**



- Universal Style / 5 Pole
- Off / On Start (Spring Back to On)
- Panel Nut and Star-Lock Washer
- Two keys included
- Has two auxiliary circuits
- Universal - used for small engine controls on many lawn and garden tractors, mowers

PART NO.	OLD NO.	DESCRIPTION
8.701-689.0	091350	Keyed Ignition Switch, 5 Pole
8.701-690.0	091351	Keyed Ignition Switch, 6 Pole

**BALDOR MOTORS - C-FACE OPEN DRIP PROOF (ODP)**



Built to "industrial" specifications.



- "S" indicates motor has on / off switch
- "B" indicates motor is black

PART NO.	OLD NO.	MOTOR HP/S	RPM	SHAFT DIA	BOLT CIRCLE	FRAME C-FACE	FULL LOAD AMPS	VOLTAGE
Single-Phase Motors								
8.709-754.0	337323B	3.0	3450	5/8"	5-7/8"	56/56C	13.7/12.5	208/230
8.709-723.0	337264B	3.0	1725	5/8"	5-7/8"	184CZ/56C	32/16	115/230
8.709-727.0	337268B	4.0	1725	5/8"	5-7/8"	182TCZ/56C	17.5/16	208/230
8.709-728.0	337269B	4.0	3450	5/8"	5-7/8"	56/56C	38/21/19	115/208/230
8.709-730.0	337271B	5.0	1725	1-1/8"	7-1/4"	184TC	25/23	208/230
8.709-731.0	337272B	5.0	3450	5/8"	5-7/8"	56HCY/56C	24/23	208/230
8.709-733.0	337273B	6.0	1725	1-1/8"	7-1/4"	213C/182TC	26	230
8.709-734.0	337275B	7.5	1725	1-1/8"	7-1/4"	215C/182TC	36/33	208/230
9.107-929.0		2	1725	5/8"		56C	16.4/8.2	115/230



## BALDOR MOTORS - OPEN DRIP PROOF (ODP)



Industrial-grade motors built specifically to meet or exceed the demands for the pressure washer industry.

- The Industry Standard
- U.L. Listed
- Any Baldor Motor Available



1 Phase, 56 Frame



1 Phase, 184T Frame



3 Phase, 184T Frame

PART NO.	OLD NO.	MOTOR HP	VOLTAGE	RPM	SHAFT DIA	FRAME	FULL LOAD AMPS	MODEL
Single-Phase Motors								
8.754-710.0		2.0	115/230V	3470	5/8"	56C		35R613R717G1
8.754-709.0		2.0	115V	1750	5/8"	56C		35Q371R021G1
8.715-090.0	5-10081	3.0	208/230V	1725	5/8"	56HC		35M895T356
8.709-751.0	337320	3.0	115/230V	1725	1-1/8"	184T	32/16	
8.715-146.0	5-1053E	5.0	208/230V	3450	3/4"	56CZ		35L3583214G1
8.715-091.0	5-10104	5.0	230V	1725	7/8"	184TCZ		36G472W849
8.709-759.0	337331	5.0	208/230V	3450	5/8"	56	23-21	
8.709-757.0	337329	5.0	208/230V	1725	1-1/8"	184T	25/23	
9.802-336.0	5-10401	6.2	230V	1725	1-1/8"	184TZ		36J185X288G1
8.715-163.0	5-1080	8.2	208V	1725	1-3/8"	215		N/A
8.715-165.0	5-1082	8.2	230V	1725	1-3/8"	215		N/A
9.804-516.0		1.5	115V	1725	5/8"	56C	13.6	35R735R770G1
9.107-929.0		2.0	115/230V	1725	5/8"	56C	16.4/8.2	EPCL1322M
8.715-158.0		2.3	115V	1750	5/8"	56C	18	35Q899R328G1
8.715-144.0		5.0	200V	3450	3/4"	56CZ	24.5	35V142R510G1
8.715-142.0		5.0	230V	1725	1-1/8"	182TZ	23	36J800X811
9.802-337.0		6.2	200V	1725	1-1/8"	184TZ	30.7	36J468Y852
8.715-102.0		7.5	230V	1725	1-3/8"	215TZ	31	37H404W885G1
8.715-168.0		8.2	230V	3450	1-1/8"	184TZ	32.8	36E002Y277G1
8.725-973.0		8.2	230V	1740	1-3/8"	215T	34.5	37L276Y712G1
8.709-793.0		10	230V	1725		215TFC		
Three-Phase Motors								
8.751-004.0		6.2	208/230/460	1725	1-1/8"	184T		36B101Y483H2
8.751-014.0	337534	7.5	208/230/460	1770	1-3/8"	213T	20.4/19.4/9.7	
8.750-999.0		8.2	230/460V	1725	1-3/8"	215		N/A
8.751-009.0		5.0	575V	1750	1-1/8"	184T	5.2	EM3218T-5
8.751-010.0		7.5	575V	1770	1-3/8"	213T	7.8	EM3311T-5
8.751-005.0		8.2	575V	3450	1-1/8"	184T	7.4	36G548S515G1
8.751-011.0		10.0	575V	1770	1-3/8"	215T	10.0	EM3313T-5
8.751-008.0		20.0	575V	1765	1-5/8"	265T	18.9	EM2515T-5

Note: Amp draw ratings require adequate wire size and full voltage to apply. Full load Amp ratings apply only when full rated.

**MOTORS - TOTALLY ENCLOSED FAN COOLED (TEFC)**



Featuring heavy-gauge steel frames, ball bearings, welded base and "snap-action" starting for reliability. Built to industrial specifications.

PART NO.	OLD NO.	MOTOR HP	RPM	SHAFT DIA	BOLT CIRCLE	FRAME / C-FACE	FULL LOAD AMPS	VOLTAGE
Single-Phase Motors								
8.709-767.0	337352	1.5	1725	5/8"	5-7/8"	56C	12/6	115/230
8.709-774.0	337363	2.0	3450	5/8"	5-7/8"	56C	17/8.5	115/230
8.709-779.0	337374	3.0	3450	5/8"	5-7/8"	56C	13.8/12.5	208/230
8.709-784.0	337380	5.0	1725	1-1/8"	7-1/4"	184T	23	230
8.709-737.0	337280	7.5	1800	1-1/8"	7-1/4"	215C	34.1/30.8	208/230
8.723-881.0		2.0	1800	5/8"		56C	7.6/8.8	115/230
Three-Phase Motors								
8.751-016.0		10.0	1725	1-3/8"		215T	29-26/13	208-230/460
8.751-318.0		5.0	1725	1-1/8"	7-1/4"	184TC	13.4/6.7	230/460

Note: Some of these motors will require two days from order to shipping

**MOTORS - A.O. SMITH - PRESSURE WASHER**



Excellent power efficiency. "S" indicates motor has on / off switch.

PART NO.	OLD NO.	MOTOR HP/S	RPM	SHAFT DIA	BOLT CIRCLE	FRAME / C-FACE	FULL LOAD AMPS	VOLTAGE
Single-Phase Motors								
8.709-808.0	337438	6.0	3450	7/8"	5-7/8"	56Y	22.0	208/230

**MOTORS - WEG - PRESSURE WASHER**



Built to industrial specifications.

PART NO.	MOTOR HP	RPM	SHAFT DIA	FRAME	FULL LOAD AMPS	VOLTAGE
Single-Phase Motors						
8.755-598.0	5.0	1760	1-1/8"	182/4T	200	14.6
8.755-599.0	10.0	1770	1-3/8"	213/5T	200	28.5
8.755-600.0	15.0	1775	1-5/8"	254/6T	200	42.8
8.755-601.0	20.0	1770	1-5/8"	254/6T	200	57.5
8.755-606.0	7.5	1770	1-3/8"	213/5T	200	21.3
8.756-431.0	20.0	1800	1-5/8"	254/6T	208/230	55.3-50.0/25.0
8.755-604.0	7.5	1770	1-3/8"	213/5T	208/230	20.5-18.5/9.25
8.755-605.0	10.0	1770	1-3/8"	213/5T	208/230	27.4-24.8/12.4
8.756-425.0	5.0	1800	1-1/8"	182/4T	208/230	14.0-12.7/6.33
8.756-429.0	15.0	1800	1-5/8"	254/6T	208/230	41.1-37.2/18.6

### SMALL ENGINE TEST EQUIPMENT



Spark Tester

- Connects between plug and plug wire
- Totally Contained Spark
- Engine will run with tester attached
- Neon test light verifies proper ignition
- Handy tool allow safe, easy visual inspection of ignition output

PART NO.	OLD NO.	DESCRIPTION
8.701-680.0	091126	Spark Tester



Compression Tester

- Designed for small engines
- 2-1/2" dial reads up to 300 PSI
- 12" flexible hose to reach spark plug holes
- Adapters for 14 mm and 18 mm spark plug holes
- Built-in pressure holding / release valves

PART NO.	OLD NO.	DESCRIPTION
8.701-682.0	091133	Comp Tester



Wireless Tachometer

- Terrific service aid for 1-cylinder engines
- Just hold built-in antenna near spark plug
- Two scales: 0-5,000 RPM or 0-15,000 RPM
- Solid-State Electronics
- Requires 9V Battery (not included)
- Excellent for setting GPM on pressure washers; accuracy within 2% of full scale

PART NO.	OLD NO.	DESCRIPTION
8.701-681.0	091132	Wireless Tach

### MOTORS - WEG - PRESSURE WASHER

Listed as individual coupler sections (half) to allow flexibility in design. For complete coupler select: Bore size for motor + Bore size for pump + Spider = Complete Coupler.

Please Note: Select halves from same series as listed in groups below. (e.g. All "090/095", "099/100")



PART NO.	OLD NO.	DESCRIPTION	BORE
090/095 Series: Up to 3 HP Electric or 4 HP Gas			
8.709-620.0	336031	Coupler Half	24 mm
8.709-640.0	336050	Coupler Half	5/8" (090)
8.709-634.0	336044	Coupler Half	3/4" (090)
8.709-639.0	336049	Buna Spider for 090 (STD)	
099/100 Series: Up to 5-7 1/2 HP Electric or 5-13 HP Gas			
8.709-626.0	336038	Coupler Half	3/4" (100)
8.709-625.0	336037	Coupler Half	20 mm (100)
8.709-627.0	336039	Coupler Half	24 mm (099)
8.709-628.0	336039A	Coupler Half	24 mm (100)
8.709-629.0	336040	Coupler Half	1" (100)
8.709-632.0	336042A	Coupler Half	1-1/8" (100)
8.709-637.0	336047	Coupler Half	1-3/8" (100)
8.709-633.0	336043	Buna Spider for 099/100 (STD)	

### PULLEYS

Fits Interpump, General and Admiral XLS, XDS Series pumps, plus XD3040, XD3047, XD3047, XD3055 and XD3065.



- Double Groove
- 24 mm Bore
- 2 x A Groove

PART NO.	OLD NO.	OD
8.711-115.0	376304	4.0"
8.711-116.0	376305	5.5"
8.711-117.0	376306	6.3"

### REFERENCE / CALCULATION GUIDE

#### CONVERSION FACTORS

- 1 inch = 25.4 mm
- 1 cm = 0.394 inch
- 1 gal H2O = 8.33 lbs
- 1 oz = 23.35 gram
- 1 gal = 3.79 liter
- 1 liter = 0.2642 gal

#### HORSEPOWER (HP) EQUATIONS

$$HP = \frac{GPM \times PSI}{1460}$$

$$PSI = \frac{HP \times 1460}{GPM}$$

$$GPM = \frac{HP \times 1460}{PSI}$$

#### QUESTIONS AND ANSWERS

- How fast do I turn my pump to give me a desired GPM?  
 Required RPM =  $\frac{\text{(Desired GPM x Rate RPM)}}{\text{Rated GPM}}$
- What size pump pulley do I use to get a certain RPM?  
 Pump Pulley Diameter =  $\frac{\text{Motor Pulley Diameter x Motor RPM}}{\text{Pump RPM}}$

**V-BELTS - SUPER "GRIPNOTCH"**



- Full Line of Belts
- "V"-notched for longer life and better performance

PART NO.	OLD NO.	SIZE
8.715-669.0		AX26
8.710-727.0	369128A	AX28
8.715-672.0		AX29
8.715-673.0	369130A	AX30
9.804-026.0		AX31
9.803-896.0		AX33
9.802-407.0		AX34
9.803-683.0		AX35
9.802-408.0	369136A	AX36
9.802-409.0		AX37
9.802-410.0	5-602038	AX38
8.715-682.0	5-602041	AX41
9.802-411.0	5-602042	AX42
9.802-412.0	5-604022	BX22
9.802-413.0		BX32
9.802-414.0	369134B	BX34
9.802-415.0	369135B	BX35
9.802-416.0	369136B	BX36
8.715-698.0	369137X	BX37
8.710-745.0	369138B	BX38
9.802-418.0		BX39
8.715-701.0	369140B	BX40
8.715-702.0	369141B	BX41
9.802-419.0	369142B	BX42
8.710-754.0	369143B	BX43
9.802-421.0	369144B	BX44
8.710-756.0	369145B	BX45
8.715-706.0		BX46
8.715-708.0		BX48
8.715-710.0		BX51

**PULLEY BUSHINGS**



- Split Taper, Malleable Iron
- Keyed to Both Shaft and Hub
- Highest Torque Carrying Capacity

Split taper "H"

For use with "H" sheaves, above.

PART NO.	OLD NO.	SIZE
Motor / Engine Bushings		
9.802-397.0		H X 5/8"
9.803-897.0		H X 3/4"
8.715-633.0		H X 7/8"
9.802-399.0		H X 1"
9.802-400.0		H X 1-1/8"
9.802-401.0		H X 1-3/8"
8.715-638.0	5-511139	H X 1-3/8" - 6B, Spline
Pump Bushings		
8.711-118.0	376320	H X 20 mm
8.711-119.0	376322	H X 22 mm
8.711-121.0	376324	H X 24 mm
8.711-122.0	376325	H X 25 mm
8.711-123.0	376330	H X 30 mm
8.711-124.0	376332	H X 32 mm
8.711-125.0	376335	H X 35 mm

**PULLEYS**



AK Pulley



2AK Pulley



BK Pulley



2BK Pulley



3TB Pulley

High-quality, cast-iron pulleys, Cast design. All sizes available.

PART NO.	OLD NO.	SIZE	OD
8.715-517.0	5-40102158	AK21*	2.10"
8.751-519.0	5-40102358	AK23*	2.30"
9.802-368.0		AK25*	2.50"
9.804-028.0		AK28*	2.80"
8.715-527.0	5-40103201	AK32H	3.25"
8.715-530.0	5-40103401	AK34H	3.45"
9.803-898.0	5-40103901	AK39H	3.75"
9.802-369.0	5-40107401	AK74H	7.25"
8.715-538.0	5-40108401	AK84H	8.25"
8.715-539.0	5-40108901	AK89H	8.75"
9.803-298.0	5-40203001	2AK30H	3.05"
9.802-371.0	5-40203201	2AK32H	3.25"
9.804-047.0	5-40203401	2AK34H	3.45"
8.715-546.0	5-40204401	2AK44H	4.25"
8.715-548.0	5-40204901	2AK49H	4.75"
8.715-549.0	5-40205101	2AK51H	4.95"
9.802-372.0	5-40205401	2AK54H	5.25"
8.715-555.0	5-40206401	2AK94H	6.25"
9.802-374.0	5-40207401	2AK74H	7.25"
9.802-375.0	5-40208401	2AK84H	8.25"
9.803-548.0	5-40209401	2AK94H	9.25"
8.715-560.0		BK30H	3.30"
9.802-377.0		BK32H	3.35"
9.802-379.0		BK36H	3.75"
8.715-566.0		BK40H	3.95"
8.710-819.0	372586	BK45H	4.25"
8.710-823.0	372596T	BK47K	4.45"
8.710-831.0	372650T	BK52H	4.95"
8.710-837.0	372695	BK60H	5.75"
8.710-841.0	372704T	BK62H	5.95"
8.715-568.0	5-40406501	BK65H	6.25"
8.715-570.0		BK70H	6.75"
8.715-571.0		BK75H	7.25"
9.802-380.0		BK80H	7.75"
8.715-573.0		BK85H	8.25"
8.710-858.0	372799T	BK100H	9.75"
8.715-576.0		2BK32H	3.35"
8.710-811.0	372499T	2BK34H	3.55"
9.802-383.0		2BK36H	3.76"
9.802-384.0		2BK40H	3.95"
9.802-385.0		2BK45H	4.25"
8.715-582.0		2BK47H	4.45"
8.715-583.0	5-4050001	2BK50H	4.75"
9.802-386.0		2BK52H	4.95"
9.802-387.0		2BK60H	5.75"
8.715-588.0		2BK62H	5.95"
9.804-060.0	5-40506501	2BK65H	6.25"
9.802-388.0	5-40506701	2BK67H	6.45"
8.715-591.0		2BK70H	6.75"
9.802-389.0	372774T	2BK80H	7.75"
8.715-593.0	372790T	2BK90H	8.75"
9.802-391.0		2BK100H	9.75"
8.715-598.0	5-406040	2TB40	4.35"
9.802-392.0	5-407034	3TB34	3.75"
9.802-394.0	5-407040	3TB40	4.35"

\* x 5/8" Bore

## OIL BURNERS - 115V / 230V



Ergonomically designed to be the most comfortable gun on the market.

- .4 to 3 GPH firing rate
- 6-1/4" Blower Fan, 115V and 230V
- 3,450 RPM Pump / Blower Motor
- Solid-State Ignition
- Beckett "CleanCut" Fuel Pump with Oil Valve
- Air Tube: 2-3/4"
- UL-Recognized

PART NO.	OLD NO.	DESCRIPTON
8.709-325.0	307032	Beckett AFG 115
8.709-326.0	307036	Beckett AFG 230

### Beckett Burner Chart

#### Burner

PART NO.	OLD NO.	DESCRIPTON	BECKET NO.
8.709-326.0	307036	AFG, 240V AC	VMG202
8.709-325.0	307032	AFG, 120V AC	VMG902
8.709-327.0	307059	ADC, 13.5V DC - W/O ICB*	VMG504
8.709-328.0	307061	ADC, 13.5V DC - W/ICB	VMG505
8.717-071.0	N/A	SM, 120V	HO1501
8.717-090.0	N/A	SM, 240V	HO1301

#### Motor

PART NO.	OLD NO.	BECKET NO.
8.750-518.0	22825U	
9.802-642.0	079602	21805U
9.802-638.0	079613	52145U
9.802-638.0	079613	52145U
8.701-090.0	079604	2364U
8.701-093.0	079609	21344U

#### Blower Wheel

PART NO.	OLD NO.	BECKET NO.
9.802-649.0	079517	2999U
9.802-649.0	079517	2999U
9.802-636.0	079518	2999AU
9.802-636.0	079518	2999AU
9.803-057.0	079515	2383U
9.803-057.0	079515	2383U

#### Ignitor Assembly

PART NO.	OLD NO.	BECKET NO.
8.751-780.0		5199701U
9.802-647.0	079669	51771U
8.751-784.0		5218301U
8.751-784.0		5218301U
9.803-060.0	079682	51824U
8.751-781.0		5199702U

#### Burner

PART NO.	OLD NO.	DESCRIPTON	BECKET NO.
8.709-326.0	307036	AFG, 240V AC	VMG202
8.709-325.0	307032	AFG, 120V AC	VMG902
8.709-327.0	307059	ADC, 13.5V DC - W/O ICB*	VMG504
8.709-328.0	307061	ADC, 13.5V DC - W/ICB	VMG505
8.717-071.0	N/A	SM, 120V	HO1501
8.717-090.0	N/A	SM, 240V	HO1301

\*Ignition Control Board

#### Fuel Pump

PART NO.	OLD NO.	BECKET NO.
9.802-644.0	079642	2184403U
9.802-645.0	079641	2184405U
9.802-562.0	079643	2184402U
9.802-562.0	079643	2184402U
9.802-645.0	079641	2184405U
9.802-644.0	079642	2184403U

\*Ignition Control Board

#### Solenoid with Cord Set

PART NO.	OLD NO.	BECKET NO.
8.900-082.0	079054X	N/A
8.900-081.0	079053X	N/A
8.900-080.0	079050X	N/A
8.900-080.0	079050X	N/A
8.900-081.0	079053X	N/A
8.900-082.0	079054X	N/A

\*Ignition Control Board

#### Tune Up Kit

PART NO.	OLD NO.	BECKET NO.
8.723-715.0	N/A	578730
8.723-715.0	N/A	578730
8.723-715.0	N/A	578730
8.723-715.0	N/A	578730
8.723-715.0	N/A	578730
8.723-715.0	N/A	578730

\*Ignition Control Board



**OIL BURNERS - 14V ADC**



- 14V, Solid-State Ignition
- 1/6 HP
- 3,450 RPM
- 4-1/4" Fan
- Max Rate 2.5 GPH
- Beckett "CleanCut" Fuel Pump with Oil Valve

PART NO.	OLD NO.	DESCRIPTION	OIL VALVE	ELECTRIC EYE	MOTOR RPM
8.709-327.0	307059	Beckett, 13.5V	Yes	-	3450
8.709-328.0	307061	Beckett, 13.5V	Yes	Yes	3450

Note: Proper operation requires an engine with 16+ Amp alternator and deep-cycle battery on nightly, overnight recharge

**FLEX COUPLINGS**



PART NO.	OLD NO.	BECKETT NO.	DESCRIPTION
9.802-648.0	079520	2454	5/16" "A" (AFG)
9.803-058.0	079522	2433	5/16" "S" (SF/SM)
9.802-637.0	079524	2140501U	1V DC ADC

**BECKETT MISC PARTS**



PART NO.	OLD NO.	BECKETT NO.	DESCRIPTION
9.802-651.0			Burner Gasket AFG 120V
8.701-059.0		578726 SDC	Electrode Insul Assy
8.701-056.0	079530	149	Electrode Clamps (All)
8.701-063.0	079542	5432	Flange, W/Gasket (All)
8.723-912.0	079543	5850	Flange, Split Unl A&S
8.701-070.0	079560	3616	Gasket, Universal AMF
9.802-653.0	079562	3416	Gasket, Unit Mtg
8.701-085.0	079595	5717 (51400)	Knurled Nut Kit ADC
8.701-134.0	079677	51304	Transf Mtg Gasket AFG
8.701-132.0	079674	31404	Transformer Clip
9.802-676.0	079654	7006U	Cadcell Flame det
8.701-137.0	079684	7556A0000	Primary Control, 14V DC
8.701-133.0	079675	3245	Transformer Spring
8.701-106.0	079629	AF90	Air Tube W/O Head
8.701-074.0	079573	5151501	Air Band (3 x 92 AFG)

**CONTROLLER AND CONTRACTOR TOOL - GENISYS™**



Advanced burner control, 120V AC primary safety control for residential and light commercial oil burners.

PART NO.	DESCRIPTION
8.751-335.0	Genisys Controller
8.726-018.0	Genisys Contractor Tool

**ELECTRODE / INSULATOR ASSEMBLY**



PART NO.	OLD NO.	BECKETT NO.	DESCRIPTION
9.802-668.0	079534	5780	Std to 9", AFG, SM, SF
8.717-978.0		578728	ADC
9.802-669.0			Electrode W/ Contact, PR
9.802-670.0			Electrode Kit

OIL BURNERS



PART NO.	OLD NO.	DESCRIPTION
8.709-317.0	307000	115V AC Burner W/ Oil Valve
8.709-318.0	307003	230V AC Burner W/ Oil Valve
8.709-319.0*	307007	12V DC Burner W/ Oil Valve

\*Proper operation requires an engine with 16+ Amp alternator and deep-cycle battery on nightly, overnight recharge

**115V and 220V Wayne Burner Chart**

- 75 to 3 GPH Firing Rates
- Solid-State Ignition (Low Amp)
- High-volume 6-1/4" blower on 220V unit, 5-3/16" blower on 110V unit
- 3,450 RPM Pump / Blower Motor
- "A"-Type Suntec Fuel Pump
- 3-3/4" air tube with adjustable flange for maximum versatility
- UL-Recognized

PART NO.	DESCRIPTION
8.709-317.0	Wayve 115V

IGNITOR	TRANSFORMER	MOTOR	BLOWER WHEEL
8.700-802.0 / 079111	8.700-804.0 / 079115	8.701-095.0 / 079612	8.700-730.0 / 079005

FUEL PUMP	SOLENOID VALVE	ELECTRODE ASSEMBLY	TUNE UP KIT
8.700-749.0 / 079030	8.700-779.0 / 079030	8.700-770.0 / 079052	8.700-774.0 / 079056

**220V Wayne Burner Chart**

PART NO.	DESCRIPTION
8.709-318.0	Wayve 220V

IGNITOR	TRANSFORMER	MOTOR	BLOWER WHEEL
N/A	8.700-809.0 / 079123	8.701-094.0 / 079611	8.700-731.0 / 079006

FUEL PUMP	SOLENOID VALVE	ELECTRODE ASSEMBLY	TUNE UP KIT
8.700-749.0 / 079030	8.700-780.0 / 079063	8.700-770.0 / 079052	8.700-774.0 / 079056

Note:  
 8.700-721.0 - Coupling for 8.700-740.0 FASCO motor used on MET to FASCO converted burner  
 8.700-720.0 - Adapter Bushing to allow MET blower wheel to work with FASCO motor  
 8.700-740.0 - Conversion Kit, use MET to FASCO conversion kit if 12V burner motor cannot be identified. The kit contains the following parts: 8.700-739.0 Motor, 8.700-720.0 Adapter Bushing, 8.700-682.0 Adapter Plate, 8.700-721.0 Coupling, 8.700-691.0 Screws (2), 8.700-104.0 Nuts



**12V Wayne Burner Chart**

- 12V Solid-State Ignitor
- 3,450 RPM Fuel Pump
- .5 to 2.75 GPH Capacity with Oil Valve

PART NO.	DESCRIPTION
8.709-319.0	Wayve 12V

IGNITOR	TRANSFORMER	MOTOR
8.700-807.0 / 079120	N/A	8.700-739.0 FASCO / 079021, 8.750-715.0 MET to FASCO 079021X

BLOWER WHEEL
8.700-727.0 / 079003 FASCO, 2.44" W x 2.53" T, 5/16" Shaft, 8.700-728.0 / 079003A, MET 3.44" W x 4.25" T

FUEL PUMP	SOLENOID VALVE
8.700-770.0 / 079052	8.700-774.0 / 079056 with 8.700-721.0 Coupling for converting from MET to FASCO

Note:  
 8.700-721.0 - Coupling for 8.700-740.0 FASCO motor used on MET to FASCO converted burner  
 8.700-720.0 - Adapter Bushing to allow MET blower wheel to work with FASCO motor  
 8.700-740.0 - Conversion Kit, use MET to FASCO conversion kit if 12V burner motor cannot be identified. The kit contains the following parts: 8.700-739.0 Motor, 8.700-720.0 Adapter Bushing, 8.700-682.0 Adapter Plate, 8.700-721.0 Coupling, 8.700-691.0 Screws (2), 8.700-104.0 Nuts

**BLOWER WHEEL**



PART NO.	OLD NO.	WAYNE NO.	DESCRIPTION	SHAFT SIZE
8.700-730.0	079005	20288 / SER	5-3/16" X 3-7/16"	1/2"
8.700-731.0	079006	21854 / SER	6-1/4" X 4-3/16"	1/2"
8.700-726.0	078999	20673	4-1/4" X 3-1/8"	1/2"
8.700-727.0	079003	21427 / SER3	12V (FASCO)	5/16"
8.700-728.0	079003A	21427	(MET)	1/2"

**COMMON PARTS - BECKETT & WAYNE**



**Brass Elbow**



**Oil Line**

PART NO.	OLD NO.	DESCRIPTION
8.701-054.0	079526	Oil Line, 6.5", Copper
9.802-667.0	079058	Oil Line, 8", Copper
8.701-053.0	079525	Oil Line, 9.5", Copper
8.700-784.0	079066	Brass 90° Elbow 1/8" Flare, 1/8" MPT
8.700-785.0	079067	Brass 90° Elbow 3/16" Flare, 1/8" MPT
8.700-738.0	079020	Oil Pressure Gauge 0-200 PSI
8.700-768.0	079051	(28737-1) Nozzle Adapter
8.705-063.0	140150	Straight Thru Double Nipple 1/8" x 1/8"

**WAYNE BURNER PARTS**



PART NO.	OLD NO.	WAYNE NO.	DESCRIPTION
8.700-774.0	079056	31156	Wayne Burner Tune-up Kit
8.700-770.0	079052	14733-001	Electrode Assembly (Pair)
		14734-002	W/ Buss Bars - G Shape
8.700-743.0	079024	12945	Buss Bar - G Shape
8.700-754.0	079034	14344	Burner Gasket
8.700-692.0	078785	12484	Universal Gasket
8.700-735.0	079014	4725	Burner Housing (E-Series)
8.700-736.0	079016	2689	Burner Flange "F"
8.700-776.0	079059	13279	Flex Coupler A Fuel Unit
8.700-777.0	079060		Coupler End (J Pump 7/16")
8.700-733.0	079010	13360	Trans Clip Screw
8.700-734.0	079011	13038	Trans Clip
8.700-729.0	079004	2668	Outer Air Band (8 Hole)
8.700-732.0	079007	2669	Inner Air Band (8 Hole)
8.700-714.0	078979	31702-014	Gun Assy, F/307007
8.700-680.0	078752		Nzl Adaper W/ Legs MSR / DC

**BURNER MOTORS**



**48M 5.75" Dia.**



**48M 7.25" Dia.**

PART NO.	OLD NO.	CAPACITOR	RPM	HP	FLANGE	VOLTAGE	WAYNE / BECKETT
9.802-642.0	079602	Y	3450	1/7	48M	115V	20627 / 21805U
8.750-518.0		Y	2850 / 3450	1/7	48M	220V	N/A / N/A
8.700-739.0	079021		4500	1/5	48M	12V DC	21993-005 / N/A
9.802-638.0	079613		3450	1/7	48M	13.5V	N/A / 52145U
8.701-090.0	079604		3450	1/4	48N	115V	N/A / 2364U
8.701-091.0	079605		3450	1/4	48N	12V	N/A / 52146U
8.701-093.0	079609	Y	3450	1/4	48N	115/240V	N/A / 21344
8.701-094.0	079611		3450	1/5	48N	240V	21328 / 21173U
8.701-095.0	079612		3450	1/5	48N	115V	20554 / 2900U
8.700-740.0	079021X	Kit, 12V DC / MET to FASCO					
Universal							
8.700-741.0	079022		3450	1/7	48M	110-60 Hz	
8.700-744.0	079025		3450	1/5	48N	110/240V	Capacitor Start

Specifications, product descriptions and product availability subject to change without notice.

## BECKETT MISC PARTS

Fits all Beckett Burners with 3" or 3-5/8" air tube.



**Kit Contains:**

- Four Becket Electrodes
- Two Couplings
- One Fuel Line
- T-Gauge

PART NO.	DESCRIPTION
8.723-715.0	Beckett Burner Tune-up Kit

## BLOWER WHEELS



PART NO.	DESCRIPTION	SHAFT SIZE
9.803-057.0	6-1/4" D x 3-7/16" W	1/2", SF-SM
9.802-649.0	4-1/4" D x 2-1/2" W	1/2", AFG
9.802-636.0	4-1/4" D x 2-7/16" W	5/16", ADC

## FUEL CONDITIONER AND SOOT REMOVER

Red Devil eliminates soot build-up.



- Easy to Use - just add to burner fuel
- Keeps burner at top efficiency
- 1 oz. Per 10 Gallons

PART NO.	OLD NO.	DESCRIPTION
8.704-625.0	112057	Pint (16 oz)
8.704-626.0	112059	Quart
8.719-158.0	9-4007	Soot-O-Magic Stick

## CLEANCUT FUEL PUMP



Simple design provides faster cleaning, more reliable cut-offs, and cut-ons. Cleaner operation - less soot. More reliable - fewer moving parts. Reduced motor load in start-up. Higher capacity - 4 GPH at 100 PSI.



- PSI: 100-200
- Factory Set PSI: 100
- Inlet Pressure PSI: 10
- Rated Speed: 3,600 RPM
- Includes built-in solenoid with cord set

PART NO.	OLD NO.	DESCRIPTION
9.802-645.0	079641	110V
9.802-644.0	079642	220V
9.802-562.0	079643	12V
9.802-646.0	079690	Valve Stem Kit (21877U)

## BURNER IGNITORS



- Solid-State Technology
- 14,000V Spark
- Only .35 AMP @ 110V
- 1.7 lbs

PART NO.	OLD NO.	BECKETT PART NO	NO MOUNTING	VOLT
9.802-647.0	079669	51771U	AFG/Lo Amp	120V
8.751-788.0	079670	5218309U		12V DC
8.751-785.0	079707	517780	SDC w/Con BD	12V DC
9.803-060.0	079682	51824U	SM/SF	120V
8.701-140.0	079687	51779U	SDC w/o CB	12V DC

\*Complete with timer

## FUEL PUMPS

- Use with Single- or Dual-Line Systems
- Pressure Adjustment Valve



PART NO.	OLD NO.	SUNTEC NO.	GPH	RPM	ROTATION
Standard Pumps					
8.700-749.0	079030	A2VA7116	3	3450	RH
8.700-789.0	A2VC7118		3	3450	LH
8.700-756.0	079031	A1YA7912	7	1725	RH
8.700-757.0	079037	A2YA7916	7	3450	RH
8.700-748.0	079028	A2RA7710			RH
Pumps with Solenoid					
8.700-758.0	079038	A2VA3106-N221R W/12V	4	3450	RH
8.700-760.0	079038-220	A2VA3006-N721RS W/220V3		3450	RH
Pump Replacement Parts					
8.700-764.0	079044	3715732 (A2VA 7116)	Pump Fuel Screen		
8.700-772.0	079055	3715744 (A2AVA 7916)	Pump Fuel Screen		
8.700-765.0	079045	3779801	Gasket Cover		

**BURNER TRANSFORMERS**



- 10,000V Spark
- 2.2 AMP @ 120V
- 8.5 lbs
- Traditional Copper-Wire Wound

PART NO.	OLD NO.	BECKETT NO.	MOUNTING	VOLT
8.751-780.0*	079668	51343U	AFG	240V
9.803-060.0*	079662	21376U	A-SF-SR-SM	120V
8.751-781.0*	079665	21176U	SM	240V

\*Bottom Mount

**BASE PLATES FOR IGNITORS**

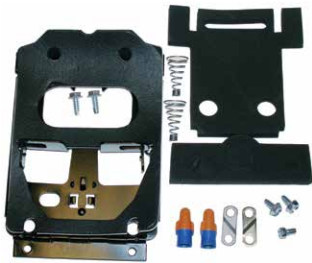

PART NO.	OLD NO.	DESCRIPTION
8.701-116.0	079644	A, Trans / Ign
8.701-117.0	079645	S, Trans / Ign
8.701-118.0	079646	E, Trans / Ign
8.701-119.0	079647	M, Trans / Ign

**NOZZLE ACCESSORIES**



PART NO.	OLD NO.	DESCRIPTION
8.700-849.0	079221	Nozzle Tray (Metal) Open Top, 55-Compartment, Plastic

**BURNER TRANSFORMERS**



- 10,000V Spark
- 2.2 AMP @ 120V
- 8.5 lbs
- FranceFormer

PART NO.	OLD NO.	WAYNE NO.	MOUNTING	VOLT
8.700-804.0	079115	23101/E	Side / EH-EHA	120V
8.700-806.0	079117	23101/M	Back / M-MSR	120V
8.700-809.0	079123	23103/E	Side / EH-EH	230V
8.700-810.0	079124	23103/M	Back / 10KVA	240V

**BURNER IGNITORS**



- Solid-State Technology
- 14,000V Spark
- Only .35 AMP @ 120V
- 1.7 lbs

PART NO.	OLD NO.	WAYNE NO.	MOUNTING	VOLT
8.700-802.0	079111	101122/001	Side/EH-EHA, France	120V
8.700-803.0	079113	101121/001	Back/M-MSR, France	120V
8.700-800.0	079107	31813-002	Side/EH-EHS, Allanson	220V
8.700-801.0	079109	31812-002	Back/M-MSR	220V
8.700-807.0	079120	31812-003	Rear Mount, Carlon	12V
8.700-820.0	079152	31813003	Side Mount (E)	12V

**FUEL SOLENOID VALVE - 12V DC KIP**



- Brass Body
- 12V DC Coil
- 1/8" FPT I/O Ports
- Conduit Connector
- 5/64" Orifice = 6 Watt

PART NO.	OLD NO.	DESCRIPTION
8.701-120.0	079652	Fuel Solenoid Valve

**SMOKE TESTER - DIAGNOSTIC TOOL**

**A Properly Tuned Burner:**

- Heats water more efficiently
- Doesn't build up soot in the coil
- Doesn't pollute the air
- Keeps your customers happy
- A tool that should be used by every serviceman in the industry



PART NO.	OLD NO.	DESCRIPTION
8.712-507.0	449020	Smoke Tester
8.712-506.0	449019	Filter Paper Refill*

\*40 sheet (10 tests per sheet)



## FUEL PUMPS



- PSI: 300
- 1/8" FPT Inlet
- Unitized mounting on Suntec fuel pumps
- Uses Standard Suntec Coil

PART NO.	OLD NO.	DESCRIPTION
8.700-779.0	079062	110V Oil Valve, R642
8.700-780.0	079063	220V Oil Valve, R753
8.700-782.0	079064	12/24V Oil Valve, R261
8.700-811.0	079125	Flow-Thru Connector Bolt
8.700-812.0	079126	Aluminum Seal Washer
8.900-081.0	079053X	110V Coil W/ Cord Set
8.900-082.0	079054X	230V Coil W/ Cord Set
8.900-080.0	079050X	12/24 Coil W/ Cord Set
9.802-640.0	079096	115V Coil W/O Cord Set
9.802-641.0	079097	230V Coil W/O Cord Set
8.700-794.0	079098	12/24V DC Coil W/O Cord Set
8.700-795.0	079099	Cord Set Only
8.900-079.0	079047	8mm Nut for Old Style Coil

## GAS JETS



Gas Jets

PART NO.	OLD NO.	DRILL SIZE	ORIFICE SIZE	USE
Gas Jets for Burner Rings* (above)				
8.710-215.0	347552	#52	(.0635)	NG
8.710-216.0	347554	#54	(.055)	NG
8.710-217.0	347562	#62	(.038)	LP
8.717-377.0		#63	(.037)	LP
8.710-218.0	347565	#65	(.035)	LP
8.710-219.0	347566	#66	(.033)	LP
9.802-684.0		#69	(.029)	LP
8.710-214.0	347549	Blank (Must Be Drilled)		

\*Due to freight damage on assembled rings / jets, separately order correct number and size of jets for each burner ring.

## VALVES - HONEYWELL GAS



9.803-615.0

### Natural Gas - Small Millivolt Valve

PART NO.	OLD NO.	DESCRIPTION
9.803-615.0	7-7000CH1	Natural Gas Millivolt Valve, 3/4" NPT
9.803-617.0	7-7CH1	Pilot for Piezo Ignitor
9.803-611.0	7-70360	47" Powerpile
9.803-614.0	7-70232	LP Conversion Kit (NG to LP)
8.718-116.0	7-7078	NG Conversion Kit (LP to NG)



9.803-616.0

### Natural Gas - Small Electronic Ignition Valve

PART NO.	OLD NO.	DESCRIPTION
9.803-616.0	7-700021	Natural Gas Electronic Ignition Valve, 24V, 3/4" NPT
9.803-618.0	7-702320	LP Conversion Kit (NG to LP)
8.718-112.0	7-70700	NG Conversion Kit (LP to NG)



8.718-048.0



9.803-612.0

### Natural Gas / LP - Large Electronic Ignition Valve

PART NO.	OLD NO.	DESCRIPTION
8.718-050.0	7-70003	Natural Gas Electronic Ignition Valve, 24V, 1" NPT (No LP Conversion Kit)
8.718-048.0	7-700022	LP Gas Electronic Ignition Valve, 24V 1" NPT (n NG Conversion Kit)
9.803-612.0	2-990581	Solenoid Pilot

See Electronic Ignition Parts Below



9.803-613.0



9.803-610.0

### Electronic Ignition

PART NO.	OLD NO.	DESCRIPTION
9.803-613.0	7-701510	Electronic Ignition Controller Back 90 sec TFI
9.803-610.0	7-702371	Pilot, Electronic Ignition
9.803-562.0	6-01352	48" Ignition Cable
8.905-681.0	6-01353	60" Ignition Cable
8.930-332.0		69" Ignition Cable

**GAS REGULATORS**



- A.G.A. Design Certified
- CGA Certified

PART NO.	OLD NO.	SIZE	VOLTAGE	MODEL NO.	BRAND
Natural Gas					
9.803-616.0	7-700021	3/4"	24V	VR8304M4002B	Honeywell
8.710-182.0	924895	3/4"	115V	36C03A41S1	White Rogers
8.717-766.0	924904	3/4"	Millivolt	VS820A-1005	Honeywell
8.718-099.0	921431	3/4"	24V	SV9601M4167	Honeywell
8.717-768.0	924870	1"	24V	700-44J	Robert Shaw
8.710-174.0	860192	1"	24V	70-05J	Robert Shaw W/Pilot
9.802-674.0	971495	1"	24V	7000 DERHC, 5N2501531	Robert Shaw
LP Gas Regulator Conversion Kits					
8.718-111.0	924897	Fits White Rogers: 924895, 924896			
8.718-113.0	924913	Fits Honeywell: 924904, 924908			
9.803-618.0	7-702320	Fits Honeywell: 921431			
9.802-688.0	924868	Fits Honeywell: 971495			
8.710-162.0	924900	Fits Robert Shaw: 924870			
8.710-187.0	860123	Fits Robert Shaw: 860192			

**PROPANE GAS REGULATORS**



- High Quality Fischer Regulators
- High and Low Pressure

PART NO.	OLD NO.	DESCRIPTION
8.717-752.0	860283	LP, FPOL x 3/4" FIP
8.717-746.0	7-1005	High Pressure
8.717-747.0	7-10050	Low Pressure
8.717-749.0	7-10052	Regulator, Propane Gas, Fisher
9.802-633.0	7-1010	LP Assembly, Includes High / Low Pressure Assy

**DRAFT DIVERTERS & RAIN CAPS**



- Prevents backdrafts, keeps cold air out
- Prevents water from running down vent pipes
- Fits on Standard Stove Pipe
- Hot Dipped Galvanized

PART NO.	OLD NO.	DESCRIPTION
8.717-764.0	924889	8" Oil Fired, Barometric Dampener
8.717-728.0*	835526	8", Round Gas-Fired
9.801-040.0*	835525	10", Round Gas-Fired
8.717-730.0*	835531	12", Round Gas-Fired
Rain Caps		
8.717-731.0	7-10033	10", Exhaust Stack, Cap
8.717-732.0	7-10034	12", Exhaust Stack, Cap

\*Available from Springdale and Camas

**PROPANE GAS HOSE**



PART NO.	OLD NO.	DESCRIPTION
8.711-853.0	867210	LP 1/4" x 10' POL x POL
8.711-856.0	707127	LP 1/2" x 48" 1/2 MNPT BE
8.711-854.0	707431	LP 1/4" x 18" MPOL BE
8.711-864.0	707432	LP 3/4" x 16" MNPT BE

**PROPANE TANKS**

PART NO.	OLD NO.	DESCRIPTION
8.717-791.0	891113	Tank, 43#, without OPD Valve

Note: No Air Freight Shipments on the Above Items

**GAS VALVES - 1" BY ROBERT SHAW**



Universal type for new equipment or replacement.

- Manual Gas Cock
- Auto-Pilot Safety Valve
- Wiring and Hardware Included
- Pilot Gas Filter
- 600,000 BTU LP Gas
- 720,000 BTU Natural Gas
- 1" Inlet / Outlet

\*Kit is for 8.710-174.0 and includes: gas valve, flame sensor, electrode pilot relight and harness

PART NO.	OLD NO.	DESCRIPTION
8.710-179.0	347407	24V AC/NG, Standing Pilot
8.710-174.0	347403	24V AC/NG, Electronic Ignition
8.710-181.0	347409	700 MV, Natural Gas
8.710-163.0*	347379	24V Retrofit Kit (NG) 720,000 BTU
9.802-677.0		Ignitor

LP Conversion Kit to Right

**LP CONVERSION KIT FOR ROBERT SHAW**



- Convert NG to LP

PART NO.	OLD NO.	DESCRIPTION
8.710-187.0	347421	1" LP Conversion Kit
8.710-164.0	347380	LP Orifice

## POWERED DAMPER



PART NO.	DESCRIPTION
8.749-806.0	Powered Damper, 10"
8.753-171.0	Powered Damper, 12"
8.755-253.0	Powered Damper, 8"
8.749-807.0	Wiring Harness

## GAS PILOTS

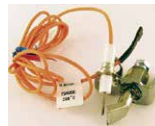

PART NO.	OLD NO.	DESCRIPTION
8.718-100.0	829858	Pilot Gas LP Gas Orifice HS
8.718-101.0	829977	Pilot Gas, Natural Gas Orifice HS
8.718-011.0	914162	Pilot Burner & Ignition
9.802-685.0	971496	Pilot Gas, Natural Gas
9.803-610.0	7-702371	NEW Pilot, Natural Gas

## DELANVAN FUEL NOZZLES



Select proper size for maximum burner efficiency.

GPH	60° A HOLLOW PART NO.	60° B SOLID PART NO.	70° A HOLLOW PART NO.	70° B SOLID PART NO.	70° AR-D PART NO.	80° A HOLLOW PART NO.	80° B SOLID PART NO.
.50	8.700-850.0	8.700-868.0	8.700-887.0	-	-	8.700-911.0	-
.60	-	-	-	-	-	8.700-912.0	8.700-932.0
.65	8.700-852.0	-	-	-	-	8.700-913.0	8.700-933.0
.75	-	8.700-870.0	-	8.700-896.0	-	8.700-914.0	8.700-934.0
.85	8.700-853.0	8.700-871.0	-	-	-	8.700-915.0	8.700-935.0
.90	8.700-854.0	-	-	-	-	8.717-333.0	-
1.00	8.700-855.0	8.700-873.0	8.717-276.0	8.700-897.0	8.756-261.0	8.700-916.0	8.700-937.0
1.10	8.700-856.0	8.700-874.0	-	-	-	8.700-917.0	8.700-938.0
1.20	8.700-857.0	8.700-875.0	-	-	-	-	8.700-939.0
1.25	8.700-858.0	8.700-876.0	-	8.700-899.0	8.756-262.0	8.700-919.0	8.717-350.0
1.35	8.700-859.0	8.700-877.0	-	-	-	9.802-584.0	8.717-358.0
1.50	8.717-328.0	8.700-878.0	8.717-278.0	-	8.756-263.0	8.700-921.0	8.717-351.0
1.65	8.700-861.0	8.700-879.0	-	-	-	8.700-922.0	8.700-943.0
1.75	8.700-862.0	8.700-880.0	8.700-892.0	8.700-903.0	8.756-264.0	8.717-329.0	8.717-352.0
2.00	8.700-863.0	-	-	8.700-904.0	8.756-265.0	8.700-924.0	8.717-353.0
2.25	8.700-864.0	8.700-881.0	-	8.700-905.0	-	-	8.700-946.0
2.50	8.700-865.0	8.700-882.0	8.700-893.0	-	-	8.700-926.0	8.700-947.0
2.75	8.700-866.0	8.700-883.0	-	-	-	8.700-927.0	8.717-330.0
3.00	-	-	-	-	-	8.700-928.0	8.717-354.0
3.25	-	-	8.700-895.0	-	-	-	8.700-950.0
3.50	-	8.700-884.0	-	-	-	8.700-929.0	8.700-951.0
4.00	-	-	-	-	-	8.700-930.0	8.700-952.0
4.50	-	-	-	-	-	8.717-331.0	8.717-367.0
5.00	-	-	-	-	-	-	8.717-357.0
6.00	8.700-999.0	-	-	-	-	-	8.700-956.0
6.50	-	-	-	-	-	-	8.700-953.0
7.00	-	-	-	-	-	-	-
8.00	-	-	-	-	-	-	-

## "SNAP" FUEL NOZZLE CHECK VALVE



Spring-loaded "snap" check valve replaces filter element on fuel nozzle. Valve opens when fuel pump pressure reaches 130 PSI and "snaps" shut when fuel pressure drops below 130 PSI. Stops "smokey" burners at start-up and eliminates "shutdown" after burn and reduces soot build-up in coil.

- Reduces nozzle fouling caused by residual fuel in orifice
- Easy field installation in standard fuel nozzles

PART NO.	OLD NO.	DESCRIPTION	PSI
8.900-083.0	079210	Snap Fuel Valve	100
8.900-084.0	079211	Snap Fuel Valve	130
8.700-845.0	079215	Snap Check Valve, 5/PK	130
8.700-844.0	079214	Snap Check Valve, 5/PK	100

**DELAVAN FUEL NOZZLES - CONTINUED**

Select proper size for maximum burner efficiency.



GPH	90° A HOLLOW PART NO.	90° B SOLID PART NO.
.50	-	8.700-981.0
.60	8.700-960.0	-
.65	8.700-961.0	-
.75	8.700-962.0	8.700-982.0
.85	-	8.700-983.0
.90	8.700-963.0	-
1.00	9.802-583.0	8.700-984.0
1.10	8.717-332.0	8.700-985.0
1.20	-	-
1.25	8.700-966.0	-
1.35	8.700-967.0	8.700-987.0
1.50	9.802-585.0	8.700-988.0
1.65	8.700-969.0	8.700-989.0
1.75	8.700-892.0	9.802-575.0
2.00	8.700-970.0	9.802-576.0
2.25	8.700-971.0	9.802-577.0
2.50	8.700-972.0	9.802-586.0
2.75	8.700-973.0	8.700-994.0
3.00	8.700-974.0	8.700-995.0
3.25	8.700-975.0	8.700-996.0
3.50	8.717-336.0	8.700-997.0
4.00	8.700-977.0	8.700-998.0
4.50	8.700-978.0	-
5.00	-	-
6.00	8.700-979.0	8.701-000.0
6.50	-	-
7.00	-	-
8.00	-	-
8.50	-	-
9.00	-	-

PART NO.	OLD NO.	GPH
8.701-018.0	079477	2.00 X 60° W
8.701-021.0	079480	1.50 X 80° W
8.701-020.0	079479	1.65 X 80° W
8.701-023.0	079481	1.75 X 80° W
8.717-342.0	079482	2.00 X 80° W
8.701-025.0	079483	2.25 X 80° W
8.701-026.0	079484	2.50 X 80° W
8.701-027.0		1.25 X 80° W
8.701-028.0	079486	2.75 X 80° W
8.701-029.0	079487	3.00 X 80° W
8.701-031.0	079490	4.00 X 80° W
8.701-039.0	079505	1.65 X 90° W
8.701-032.0	079492	2.00 X 90° W
8.723-697.0		0.85 X 80° W
8.723-698.0		0.90 X 80° W
8.723-699.0		1.10 X 80° W
8.723-700.0		1.20 X 80° W
8.740-139.0		1.25 X 60° W
8.723-701.0		1.35 X 80° W
8.701-015.0		1.50 X 60° W
8.701-017.0		1.75 X 60° W
8.701-013.0		2.25 X 45° W
8.701-034.0		2.25 X 90° W
8.701-026.0		2.50 X 80° W
8.701-028.0		2.75 X 80° W
8.701-035.0		2.75 X 90° W

Note: The Above "W" Nozzles Are Stocked - All Sizes Are Available

## GAS VALVES - LP OR NATURAL



Universal-type for building new systems or field replacement. 750 MV, 24V or 120V controls by White-Rodgers.

- 335,000 BTU Max
- 3/4" Inlet / Outlet
- All adjustments and wiring connections on top of valve
- Automatic Outlet Pressure Regulator
- A.G.A. Design Certified, C.G.A. Certified

PART NO.	OLD NO.	DESCRIPTION
8.710-172.0	347400	Gas Valve 24V (1)
8.710-182.0	347410	Gas Valve 120V (2)
8.710-183.0	347412	Gas Valve 750 MV (1)
8.750-110.0		3/4" NG to LP Conversion Kit
8.750-109.0		3/4" LP to NG Conversion Kit

(1) Includes two 3/4" x 1/2" all-thread plated bushings and valve instructions. (2) Includes L.P. Kit, two 3/4" x 1/2" and one 1/2" x 3/8" all-thread plated bushings and all instructions.

### White-Rodgers Repair Parts

PART NO.	OLD NO.	DESCRIPTION
8.710-184.0	347416	24V Cycle Pilot Control (347425)
8.710-198.0	347446	Gas Ignition Electrode (24" Lead)

## GAS VALVE ACCESSORY COMPONENTS



8.710-190.0

Use with both 3/4" and 1" models on this page.

PART NO.	OLD NO.	DESCRIPTION
8.710-190.0	347430	750 MV Generator
8.710-191.0	347431	P110T Pilot Burner (Natura Gas)
8.718-092.0	347436	Thermo Couple (W/24") Cap Tube
8.710-196.0	347438	Thermo Couple (W/36") Cap Tube
9.802-686.0		Thermopile, VNG, 44

## INSULATION AND RIGID DISC / DONUTS

Refractory-grade ceramic Kaowool formed; retains heat inside coil for better fuel efficiency and paint protection.



PART NO.	OLD NO.	DESCRIPTION	THICKNESS	WIDTH	LENGTH
"Rigid Formed" Donut and Discs					
8.704-807.0	122253	Donut	.88"	18" 6"/4	4"
8.704-810.0	122258	Donut	.88"	16" 6"/4	4"
8.717-474.0		Donut		24"	
8.704-808.0	122254	Disc	1/2"	18"	
8.704-809.0	122257	Disc	1/2"	16"	
8.717-475.0		Disc		24"	
Insulation Blanket					
8.901-288.0	122204	Coil Wrap	1"	24"	4'
8.901-289.0	122205	Coil Wrap	1"	24"	5'
8.704-800.0	122206	Coil Wrap	1"	24"	6'
8.704-802.0	122222	Full Roll	1/2"	24"	37.5'
8.704-805.0	122225	Full Roll	1"	24"	25'



**LEGACY FLOW SWITCH**



- PSI: 5000
- GPM Max: 10, GPM Min: 1.8
- Temperature: 180°F
- AMP: 3, 12-250V
- Horizontal or vertical mount
- 3/8" FPT Inlet / Outlet
- 2 Wire Reed
- 62" Cord Length

PART NO.	OLD NO.	DESCRIPTION
8.933-006.0		MV60, Vertical or Horizontal Mount
8.712-244.0		AP 500, Vertical Mount Only
9.803-266.0	109672	Reed Switch (AP) (2 wire)

**PHOENIX FLOW SWITCH WITH PILOT**



- PSI: 4000
- GPM: 7.5 - 16.0
- Temperature: 165°F
- AMP: 3, 250V
- 3/8" F Inlet / Outlet Ports
- 96" Reed Cord
- Includes 8 mm Pilot
- 2.5 lbs
- Mounting Hole

PART NO.	OLD NO.	DESCRIPTION
8.712-252.0	410320	Switch with Pilot
8.712-253.0	410322	Reed Switch

**FLOW SWITCH**



ST-5

- PSI: 3600
- GPM: 8.0
- Temperature: 180°F



ST-6

- AMP: 3, Reed Switch
- 3/8" Inlet / Outlet Ports
- Brass Body

PART NO.	OLD NO.	DESCRIPTION
8.757-669.0	410305	ST-5 Vertical Mount Only (47" Wire Length)
8.757-668.0	410306	ST-6 Horizontal or Vertical Mount (47" Wire Length)
8.757-670.0		Reed Switch for ST-5 and ST-6 New Style

**GENERAL PUMP TMT FLOW SWITCH**



- PSI: 5000
- GPM: 1.5 at PSI: 50
- Minimal Pressure Drop Up to 12 GPM Flow
- Activates with 1.5 GPM Flow
- Temperature: 40° - 180°F
- AMP: 5, 250V
- 3/8" F Inlet / Outlet Ports
- 48" Electrical Lead Length
- 1.0 lbs
- Can be mounting in any position
- Micro-Switch technology eliminates reed switch

PART NO.	OLD NO.	DESCRIPTION
8.712-258.0	100934	Inline Flow Switch

**LEGACY FLOW SWITCH**



Spring return float allows full mounting versatility.



- PSI: 4050
- Rated Pressure: 3500
- GPM: 8.0
- Temperature: 190°F
- Horizontal or vertical mount
- Forged Brass Body
- 3/8" MPT Inlet / Outlet
- One Amp Switch
- Solenoid Control

PART NO.	OLD NO.	DESCRIPTION
8.712-246.0	410307P	Flow Switch

**FLOW SWITCH - STAINLESS STEEL**



- PSI: 7300
- GPM: 1.0 - 8.0
- Temperature: 176°F
- 3/8" Inlet / Outlet
- Stainless-Steel
- 47" Wire Length

PART NO.	OLD NO.	DESCRIPTION
8.723-665.0	87236650	ST-505 Flow Switch

**VAC SWITCH - BURNER CONTROL**

Normally open (NO) switch closes when pump vacuum begins drawing water and opens when vacuum is broken due to pump shutdown or empty water tank.



- Temperature Max: 140°F
- Heavy-duty, 16 Amp Contacts
- 1/4" FPT Connect

**FLOW SWITCH**



- PSI: 5000
- GPM: 12.0
- Temperature: 176°F
- 3/8" Inlet / Outlet Ports
- Micro Switch

PART NO.	DESCRIPTION
8.755-296.0	ST-7 Horizontal or Vertical Mount (47" Wire Length)

PART NO.	OLD NO.	DESCRIPTION
8.712-391.0	413031	1.5" (HG) Vac Switch
8.712-392.0	413032	2.5" (HG) Vac Switch
8.712-393.0	413034	4.5" (HG) Vac Switch

## PRESSURE SWITCH

**Legacy**

Operation without opening switch case: Blue = Common  
CONNECT: Red / Blue = N/C, Blue / Brown = N/O



- PSI: 360
- Temperature: 200°F
- AMP: 15, 115V or 230V AC
- Stainless-Steel Plunger
- 1/4" and 3/8" MPT Nipple
- 3 Wire, Internally Wired for either N/O or N/C
- 42" Wire Length

PART NO.	OLD NO.	DESCRIPTION
8.712-261.0	411060	Pressure Switch (Switches @ 360 PSI)
8.712-262.0	411060-40	Pressure Switch 1/4" MPT (Switches @ 580 PSI)
8.751-272.0		Pressure Switch 3/8"
8.701-311.0	082023	Micro Switch (15 AMP 115/230V AC)

Note: 10 AMP 28V DC Micro Switch available. Excellent for use on 12V DC Hot Pressure Washers.

## COMPACT PRESSURE SWITCH

3-Amp rating provides the switching power to control fuel solenoids just like the large switches. Body measures 1" x 1-1/4" x 2" (not including wire or connector).



- PSI Max: 3600
- Switch Pressure PSI: 580
- Temperature: 200°F
- AMP: 3 Switch Rating, 250V
- 1/4" Brass MPT Connect
- Stainless-Steel Plunger
- Stainless-Steel Plunger
- 48", 3 Wire Cable for use in either NC or NO application: Blue = Common Brown = No Red = NC

PART NO.	OLD NO.	DESCRIPTION
8.712-260.0	411050	Compact Pressure Switch
8.712-270.0		Pressure Switch AL 3/8" Stainless 435 PSI

## BLACK PRESSURE SWITCH



- PSI: 3600
- Switching Pressure PSI: 580
- Temperature: 195°F
- AMP: 15, 250V
- 1/4" Male Inlet
- Brass Stem and Stainless-Steel Nipple
- 45" Wire Length
- 8 oz

PART NO.	OLD NO.	DESCRIPTION
9.802-458.0	6-021720	Black Pressure Switch

## RED PRESSURE SWITCH



- PSI: 5800
- Switching Pressure PSI: 640
- Temperature: 195°F
- AMP: 15, 250V
- All Stainless-Steel Construction
- 3/8" Male Inlet
- 10 oz
- 44" Wire Length

PART NO.	OLD NO.	DESCRIPTION
8.712-267.0	411065	Red Pressure Switch
8.704-572.0	111459	Heavy-duty Micro Switch

## TOGGLE / PUSH BUTTON SWITCH



- 7/16" Mounting Bushing
- 1/2" Diameter Mounting Hole Required
- Mounting Hardware Included

PART NO.	OLD NO.	DESCRIPTION	HP*	CONNECTS
8.712-319.0*	411605	SPST, 20A/110V	1.0	M/Spade
8.712-320.0	411607	DPST, 20A/110V		M/Spade
8.709-705.0*	337206	DPST, 20A/125V	1.5	Screw
8.709-704.0*	337205	DPST, 20A/250V	2.0	Screw
8.709-054.0*	285140	SPST, 20A/120V	3/4	M/Spade
8.709-065.0*	285189	DPST, 20A/120V	3/4	Screw
8.716-078.0		SPST, 20A/120V	1.5	
8.709-706.0	337207	Switch Guard		
8.716-081.0		Waterproof Switch Protector		
Push Button Switches				
8.709-053.0	285139	SPST, 5A/120V, Push On / Push Off		Screw
8.709-064.0	285187	SPST, 15A/120V, Push On / Push Off		Screw

\*Motor Rated

## TOGGLE SWITCH



- AMP: 30, 600V DPST
- Rated For: 2 HP Motor at 115V  
3 HP Motor at 230V
- With or Without Box

PART NO.	OLD NO.	DESCRIPTION
8.709-696.0	337187	Switch Only
8.903-802.0	337188	Switch and Rain Tight Box
8.709-708.0*	337210	Switch W/NEMA 1 Box

\*Not Rain Tight (Baldor Replacement)

**HIGH-LIMIT SWITCH**



8.712-306.0

- PSI: 4000
- AMP: 15 at 110V, AMP: 10 at 220V
- 1/4" Male Spade Lug Terminals
- 1/2" MPT external thread connects for attaching conduit or PVC wire connectors
- UL / CSA Rated, Bimetal Switch Components
- Heavy-Duty Brass Housing - 7000 PSI Collapse Rating
- Normally used with other adjustable or fixed range thermostat which regulates water temperature
- Does not turn back on until water has cooled 50° - 70°F
- Operates as a safety device to shut off burner to prevent machine (water) overheating flashing to steam

PART NO.	OLD NO.	PROBE MPT	TEMP
8.712-301.0	411254	3/8"	120° F
8.712-206.0		3/8"	140° F
8.753-450.0		3/8"	160° F
8.712-304.0	411262	3/8"	170° F
8.712-306.0	411266	3/8"	180° F
8.712-311.0	411276	3/8"	230° F
8.712-179.0		1/2"	180° F
8.712-308.0	411270	1/2"	210° F
8.712-298.0		1/2"	230° F
8.712-316.0	411332	1/2"	330° F
8.705-351.0	141538	1/2"	PVC Coupler

**HIGH-LIMIT SWITCH WITH WIRE LEAD**



- AMP: 15 at 110V, AMP: 10 at 220V
- 1/4" Male Spade Lug Terminals
- 1/2" MPT external thread connects for attaching conduit or PVC wire connectors
- UL / CSA Rated, Bimetal Switch Components
- Does not turn back on until water has cooled 50° - 70°F
- Heavy-Duty Brass Housing - 7000 PSI Collapse Rating
- Normally used with other adjustable or fixed range thermostat which regulates water temperature
- Operates as safety device to shut off burner to prevent machine (water) overheating flashing to steam

PART NO.	PROBE MPT	WIRE LEAD	TEMP
8.712-185.0	1/2"	42"	225° F
8.712-205.0	1/2"	42"	330° F

## EATON CULTER-HAMMER DP CONNECTORS

Cutler-Hammer



- Cutler-Hammer Quality
- Type C25 definite purpose contactors feature a compact, efficient design with low-VA coil
- Din Rail Mounting

PART NO.	COIL VOLTAGE	FL AMPS	MOTOR HP @ 115V 1PH	MOTOR HP @ 230V 1PH	MOTOR HP @ 230V 3PH	MOTOR HP @ 460V 3PH	MOTOR HP @ 575V 3PH
8.724-267.0	24V	15	.75	2	3	5	5
8.724-264.0	115V	15	.75	2	3	5	5
8.724-265.0	230V	15	.75	2	3	5	5
8.724-266.0	460V	15	.75	2	3	5	5
8.724-269.0	24V	25	2	3	7.5	10	10
8.724-268.0	115V	25	2	3	7.5	10	10
8.724-270.0	230V	25	2	3	7.5	10	10
8.724-271.0	460V	25	2	3	7.5	10	10
8.724-275.0	24V	30	2	5	10	15	15
8.724-272.0	115V	30	2	5	10	15	15
8.724-273.0	230V	30	2	5	10	15	15
8.724-274.0	380V	30	2	5	10	15	15
8.724-280.0	24V	40	3	7.5	10	20	20
8.724-276.0	115V	40	3	7.5	10	20	20
8.724-277.0	230V	40	3	7.5	10	20	20
8.724-279.0	380V	40	3	7.5	10	20	20
8.724-278.0	460V	40	3	7.5	10	20	20
8.724-283.0	24V	50	3	10	15	30	30
8.724-281.0	115V	50	3	10	15	30	30
8.724-282.0	230V	50	3	10	15	30	30
8.724-286.0	24V	60	5	10	20	40	40
8.724-284.0	115V	60	5	10	20	40	40
8.724-285.0	230V	60	5	10	20	40	40
8.735-015.0	115V	65	5	15	25	50	60

XT OVERLOADS FOR  
DP CONTACTORS

Cutler-Hammer



- Cutler-Hammer Quality
- Direct Heated Bimetal Elements
- Adjustable Trip Current
- Manual / Automatic Reset

PART NO.	AMP RANGE
8.724-297.0	0.4 - 0.6
8.724-298.0	0.6 - 1.0
8.724-300.0	1.6 - 2.4
8.724-301.0	2.4 - 4.0
8.724-302.0	4.0 - 6.0
8.724-303.0	6.0 - 10.0
8.724-312.0	10.0 - 16.0
8.724-304.0	16.0 - 24.0
8.724-305.0	24.0 - 32.0
8.724-306.0	24.0 - 40.0
8.724-307.0	40.0 - 57.0

PUSH BUTTON AND  
CONTACT BLOCKS

Cutler-Hammer

- Cutler-Hammer Quality
- Heavy-Duty
- Water Tight / Oil Tight



9.803-974.0      9.803-973.0      8.716-718.0      9.802-534.0

PART NO.	OLD NO.	MODEL NO.	DESCRIPTION
9.803-666.0	6-2004	CH C320KGS3	Contact Block, N/O, N/C
9.802-534.0	6-2000	CH E22B1	Contact Block, N/C
9.802-535.0	6-2001	CH E22B2	Contact Block, N/O
9.803-974.0	6-2021	CH E22PB3	Switch, Green Push Button
9.803-973.0	6-2022	CH E22EB2	Switch, Red Push Button
8.716-718.0	6-2023	CH E22VB51	Switch, 2-Position Lever

## MAGNETIC MOTOR STARTERS

For pressure washer and carwash applications.

- 24V AC Control
- 10 - 240V, 30 - 240V or 480V Contractor
- Componentized for Flexibility
- Thermal overloads adjustable within range shown
- Electrical Life: 1,000,000 + Cycles
- Mechanical Life: 20,000,000 + Cycles
- Contacts: 90% Silver, 10% Cad-Oxide

### Contactor



TYPE	24V COIL PART NO.	24V COIL PART OLD NO.	120V COIL PART NO.	120V COIL PART OLD NO.	220V COIL PART NO.	220V COIL PART OLD NO.	FL AMP	220V 10 HP	220V 30 HP	440V 30 HP
<b>CONTACTORS UL RATING</b>										
A	8.708-753.0	260265	8.902-527.0	260290	8.902-532.0	260295	22	2	3	5
B	8.708-754.0	260266	8.902-528.0	260291	8.902-533.0	260296	24	2	5	7.5
C	8.902-523.0	260267	8.902-529.0	260292	8.902-534.0	260297	32	3	5	10
D	8.902-524.0	260268	8.902-530.0	260293			40	5	7.5	15
E	8.902-526.0	260269	8.902-531.0	260294	8.902-536.0	260299	52	7.5	10	20

### Coil



PART NO.	OLD NO.	VOLTAGE	FITS CONTACTOR
Coils Only			
8.708-764.0	260274	24v	A,B,C,D
8.708-765.0	260275	480v	A,B,C,D
8.708-766.0	260277	120v	E
8.708-767.0	260278	220v	E

### Overload



PART NO.	OLD NO.	TYPE	AMP RANGE	FITS CONTACTOR
Thermal Overloads				
8.708-749.0	260253	Man	9.0 - 15	A,B,C,D
8.708-760.0	260271	Man	17 - 26	A,B,C,D
8.708-742.0	260247	Man	20 - 33	C,D
8.708-744.0	260248	Man	28 - 42	C,D
8.708-750.0	260253	Auto	9.0 - 15	A,B,C,D
8.708-759.0	260270	Auto	14 - 23	A,B,C,D
8.708-743.0	260247	Auto	20 - 33	C,D
8.708-747.0	260249	Auto	35 - 50	E,F

- Used to Mount Overload to Motor Starter Contractors

PART NO.	OLD NO.	FITS CONTACTOR
Thermal Overloads		
8.708-768.0	260281	A,B,C,D
8.708-789.0	260349	F

## RELAY SWITCH



PART NO.	OLD NO.	DESCRIPTION
8.716-087.0	875826	DPST NO 24VAC Omron 2000 Series

## MOLDED POWER CORD

- Water Tight
- Factory Finished Look

PART NO.	OLD NO.	DESCRIPTION
8.752-150.0	826024	3' 14/3 W/Plug



## ON / OFF ROTARY SWITCH



9.802-449.0

- Single or Three Phase
- Heavy-Duty
- 2 Position or 3 Position

PART NO.	OLD NO.	DESCRIPTION
9.802-450.0	876028	2-Position 115V / 600V
9.802-449.0	876058	3-Position 115V / 230V, 1PH, 20 Amp
8.716-027.0	6-020203	3-Position 230V / 460V, 3PH
8.716-030.0	950552	Rotary Switch

## RELAYS



9.802-468.0



8.716-230.0



9.802-467.0



9.802-470.0



8.716-264.0



8.716-257.0

PART NO.	OLD NO.	DESCRIPTION
9.802-468.0	6-03621	120V, RH2B-UI-AC120 for Pressure Washers
8.716-209.0	6-03521	240V, RH2B-UI-AC240
9.802-467.0	6-03541	Base, SH2B-05 for IDEC
8.716-230.0	6-0367	24V, IDEC CLP
8.716-264.0	6-0381	Power Deltrol, 120V for SJ-5
8.716-257.0	6-0374	Relay, Power Omron G4B112T1FDCUSRAC120 for Delta / Alpha
9.802-470.0	6-03671	P&B/VF4-41F11, 12V DC, 40 Amp for 12V DC Units 13 HP and Below
9.802-471.0	6-036711	Relay, P&B, 24V/40 A for 12V DC Units over 13 HP

## STEP-DOWN TRANSFORMERS



8.716-899.0



9.802-553.0



8.716-904.0

- Industrial Duty
- High-Quality Cutler-Hammer
- Drops primary voltage to selected secondary voltage

PART NO.	OLD NO.	PRIMARY V	SECONDARY V	SIZE
8.716-593.0	6-05234	600V	120V/240V	1.0KvA
8.716-899.0	6-6031	380V/400V/415V	110/220V	.750KvA
9.802-553.0	6-60121	120V/240V	24V	.050KvA
8.716-904.0	6-6035	120V/240V	24V	.100KvA
8.716-883.0	6-60161	208V/230V/460V	24V/115V	.050KvA
9.804-556.0	6-60141	208V/277V	120V	.050KvA
8.716-882.0	6-60151	208V/277V	120V	.075KvA
9.803-971.0	6-6025	380V	24V	.050KvA
8.716-875.0	6-60051	240V/480V	120V/240V	.200KvA
9.802-550.0	6-60021	240V/480V	120V/240V	.500KvA
9.802-552.0	6-60111	240V/480V	120V	.075KvA
9.802-551.0	6-60101	240V/480V	120V	.050KvA
9.803-668.0	6-60131	550V/575V/600V	115V	.050KvA

JUNCTION BOXES



9.802-474.0



8.716-269.0



8.716-271.0



9.802-475.0



9.802-476.0



9.802-477.0



8.716-280.0,  
8.716-281.0,  
8.716-272.0



8.716-320.0



8.716-321.0



8.716-322.0



8.716-326.0

PART NO.	OLD NO.	DESCRIPTION
9.802-474.0	6-0390	VNG Remote, Plastic
8.716-269.0	6-03901	12" x 12" x 4", Metal VNG Remote Box
8.716-271.0	6-03904	Fiberglass, NEMA1 for PE Units
8.716-272.0	6-03906	12" x 10" x 5.25" for Solid Sep
9.802-475.0	6-03907	8" x 8" x 6", Box, Plastic with Lid for SEA 3-1100
9.802-476.0	6-03909	10" x 8" x 6", Box, Plastic with Lid for SEA
9.802-477.0	6-03910	Box, Plastic without Lid E9081
9.802-478.0	6-03911	Lid, Plastic for 9.802-477.0
8.716-280.0	6-03912	18" x 16" x 9.25", Plastic for CLP, WB
8.716-281.0	6-03913	14" x 16" x 6.75", Plastic for HBG, AMC
8.716-320.0	6-0409	Cover, Duplex Receptacle for Alpha
8.716-321.0	6-0410	2" x 4", 3-Hole, 1/2" WB, for CLP
8.716-322.0	6-04101	2" x 4", Extension for 8.716-321.0, 8.716-323.0, 8.716-324.0
8.716-323.0	6-04102	2" x 4", 5-Hole, 1/2" for CLP
8.716-324.0	6-04103	2" x 4", 4-Hole, 1/2" for CLP
8.716-326.0	6-04104	4" x 4", 3-Hole, SK Series for Alpha / PK
8.716-327.0	6-041041	4" x 4", 5-Hole, 1/2" for WB
8.716-329.0	6-041043	4" x 4" SK, Cover Plate for WB for 6-00041
9.802-483.0	6-0411	2" x 4", Cover Plate for 8.716-321.0
9.802-484.0	6-04110	2" x 4", Junction 3-Hole, 3/4"
8.716-339.0	6-041100	2" x 4", 3-Hole, 1" for ENG

ENCLOSURE BOX FOR MAGNETIC MOTOR STARTER SETS



- NEMA 65 non-metallic enclosure dimensions: 4-1/3" W x 4" D x 6" H
- 8 (1/2" - 3/4") Wiring Knockouts on Box
- Holes, pre-drilled for mounting contactor and overloads with mounting screws included

PART NO.	OLD NO.	DESCRIPTION
8.902-525.0	260268X	Box, Toggle and Hardware

MANUAL MOTOR STARTER WITH SEALED BOX



- AMP: 25 with Adjustable Overload
- Adjustment Range AMPS: 20-25
- Sealed Box: 3-1/4" W x 3-1/2" D x 6-1/2" H
- 110-500V IEC-Rated
- Two-Cord Grip Fit 1/2" Threaded Knockouts
- Protective Cover Over Buttons
- Single and 3-Phase Wiring Instructions

PART NO.	OLD NO.	DESCRIPTION
8.709-709.0	337212	Motor Starter

## RAINTITE SWITCH BOX



- UL 728A
- Box: 2-3/4" x 5-1/2" x 2"
- Three 1/2" Tapped Holes

- Box includes two plugs, ground screw and mounting lugs
- Cover Includes Gasket

PART NO.	OLD NO.	DESCRIPTION
8.709-702.0	337203	RainTite Switch Box
8.709-703.0	337204	Switch Box Cover

## TIMER



- Preset and Adjustable Available
- Heavy-Duty

PART NO.	OLD NO.	DESCRIPTION
9.802-472.0	6-036880	Solid State, 5-60 Min for Auto Start

## CIRCUIT BREAKERS



- Provides protection against excessive Amp draw

PART NO.	OLD NO.	DESCRIPTION
9.802-485.0	6-041250	25 Amp (All 12V Systems)

## FUSES



- Full range of fuses
- Protect your equipment

PART NO.	OLD NO.	CODE	MAX V	AMPS
9.802-463.0	6-022970	FNM1/2	250V	0.5
9.802-464.0	6-0229810	FNM8/10	250V	0.8
8.716-173.0	6-0229710	FNM1	250V	1.0
9.803-977.0	6-02320	FNM2-1/2	250V	2.5
8.716-187.0	6-023080	FNM3	250V	3.0
9.803-664.0	6-023090	FNM5	250V	5.0
8.716-194.0	6-02321	FNM7	250V	7.0
9.802-460.0	6-022910	FNM8	250V	8.0
8.716-165.0	6-022920	FNM10	250V	10.0
8.716-191.0	6-02311	FNQ3/10	500V	0.3
8.716-192.0	6-02312	FNQ6/10	500V	0.6
9.802-465.0	6-02306	FNQ-R-3	600V	3.0
8.716-169.0	6-02296	KTK-R1/4	600V	0.25
9.802-462.0	6-02295	KTK-R1/2	480V	0.5
8.933-007.0	6-02294	KTK-R1	240V	1.0
8.716-177.0	6-022982	KTK-R1-1/2	600V	1.5
9.803-663.0	6-02299	KTK-R2	120V	2.0
8.716-179.0	6-022990	KTK-R2-1/2	600V	2.5
8.716-180.0	6-022992	KTK-R4	600V	4.0
9.804-050.0	6-02307	KTK-R5	600V	5.0
8.716-183.0	6-02304	KTK-R30	600V	30.0
8.716-170.0	6-02297	MDL1/2	120V	0.5
8.716-175.0	6-022981	MDL3/4	250V	0.75
8.716-172.0	6-022971	MDL1	250V	1.0
8.716-174.0	6-02298	MDL2-1/2	24V	2.5
8.716-186.0	6-02308	MDL3	250V	3.0
8.716-188.0	6-02309	MDL5	250V	5.0
8.716-161.0	6-02291	MDL7-1/2	250V	7.5
8.716-163.0	6-022911	MDL8	250V	8.0

### MACHINE CONTROL CAM SWITCHES, 3-POSITION



- Heavy-Duty Rotary Cam Switches
- Legend plate reads off / pump / burner
- Quick make / break action reduces arcing
- Wiring Boot Included (Except 410242-3)
- Legend Plate, 2/1/2" Square
- 4-Screw Mounting

PART NO.	OLD NO.	MODEL	AMP RATING	VOLTAGE	PHASE
8.712-219.0*	410210	S220-1686	20	110V	1Ø
8.712-224.0*	410221	S220-1687	20	220V	1Ø
8.712-225.0*	410223	S220-1688	20	220V	3Ø
8.712-227.0*	410231	S225-1686	30	110V	1Ø
8.712-228.0*	410232	S225-1687	30	220V	1Ø
8.712-229.0*	410233	S225-1688	30	220V	3Ø
8.712-234.0	410242	S432-4095	40	240V	1Ø
8.712-235.0	410243	S432-1402	40	480V	3Ø
Single-Hole Mounting - Requires 1 22mm (7/8" Dia) hole					
8.712-218.0	410208	220-1789	20	110V	1Ø
*Replacement Knob - Fits those part numbers above marked with an asterisk (*)					
8.700-258.0	075052	Replacement Knob			

### CAM SWITCH AND BOX, 60 AMP ON / OFF



Cam action fast "make-break" to reduce arcing.

- 60 Amp disconnect rating
- Four 1/2" Knock-Outs
- Versatile Mounting
- Motor Ratings:  
7.5 HP at 24vt 1Ø  
5.0 HP at 240vt 3Ø  
30 HP at 480vt 3Ø

PART NO.	OLD NO.	DESCRIPTION
8.712-217.0	410206	63 Amp Switch W/Large Box 4-1/2" W x 7" H x 3-3/4" D
8.712-211.0	410190	60 Amp Switch Only, No Knob
8.712-212.0	410192	Box Only 3-7/8" x 4-7/8" x 2-3/4" for 410190 Switch Using 10 Gage / Smaller Wire
8.700-489.0	076521	Knob

Note: Switch does not have thermal overload protection

### CAM SWITCH "BIG BOOT" 3-POSITION



Large rectangular boot for easier wiring.

- Mounting configuration and electrical ratings same as "S" switches

PART NO.	OLD NO.	MODEL	AMP RATING	VOLTAGE	PHASE
8.712-238.0	410260	T225-1686	30	110V	1Ø
8.712-241.0	410265	T225-1688	30	240V	3Ø
Single-Hole Mounting - Requires One 22 mm (7/8" Dia) Hole					
8.712-223.0	410219	220-1843	20	220V	1Ø

### UNIVERSAL "ELEKTRA"

8.712-236.0



UL/CSA-rated machine control cam switches.

- Position "off" - "pump burner"
- Quick make / break action - reduces arcing
- 2 or 4 Screw Mount (2-1/2" Square Legend Plate)
- Matches Salzer / Kraus, Naimer / Brema's & Klockner, Moeller Mounts
- "Boot" has plenty of wiring room
- "Tite Boot" excellent dust and moisture seal
- Screw-to-screw, terminal-to-terminal replacement for Salzer "S" and "J" type switches above
- Contacts UL / CSA Rated:  
24 Amp vs 20 Amp, 35 Amp vs 30 Amp,  
50 Amp vs 40 Amp

8.712-237.0



8.712-240.0



PART NO.	OLD NO.	AMP RATING	WIRING POLES	VOLTAGE	PHASE	HP RATING
8.712-236.0	410251	25	1	120V	1	1.5
8.712-237.0	410253	25	2	120V / 240V	1	1.5 / 2.0
8.712-240.0	410263	35	2	120V / 240V	1	2.0 / 3.0
8.712-242.0	410267	50	2	120V / 240V	1	3.0 / 7.5

Note: None of the Elektra switches are for use on 3-phase motors without adding fuses or thermal overload

## ON / OFF SWITCH WITH BOX "ELEKTRA"



UL/CSA-rated 25 and 35 Amp. Compact 3-1/4" square x 3-3/4" deep enclosure "versatile mount."

PART NO.	OLD NO.	AMP RATING	WIRING POLES	VOLTAGE	PHASE	HP RATING
8.712-214.0	410203	25A	2	120V / 240V	1	1.5 / 2.0
8.712-216.0	410205	35	2	120V / 240V	1	2.0 / 3.0

Note: None of the Elektra switches are for use on 3-phase motors without adding fuses or thermal overload

## WINCO AC GENERATOR



2400 Watt, 120 VT, 3600 RPM, 20 Amps.

- 13.3" L x 7.6" W x 8.1" H
- 33 lbs Weight
- Starts and Runs 1/2 HP Motor
- 7/8" diameter shaft
- Conforms to UL1004-1, UL1004-4 and CSA 22.2 No. 100-24



PART NO.	DESCRIPTION
8.756-638.0	TB2400 Generator

## VOLTMASTER GENERATOR



2500 Watt, 120V, 21.6 Amp at 3,600 RPM

- 36.5 lbs Weight
- Brushless Design
- Shaft rotates either direction
- Circuit breaker protection (standard)
- 7/8" Shaft, Two Sealed (Ball) Bearings
- Industrial-Type Watertight Enclosure (11-5/8" x 7-1/2" Diameter)
- All Copper Windings, High Surge Capacity

PART NO.	OLD NO.	DESCRIPTION
8.709-810.0	337441	2500 Watt Generator

## ROCKER SWITCHES



9.802-453.0 8.716-051.0

2500 Watt, 120V, 21.6 Amp at 3,600 RPM

- On / Off Switch
- Lighted Available
- 125V / 250V



9.802-451.0 9.802-452.0

PART NO.	OLD NO.	DESCRIPTION	AMP	VOLTAGE
9.802-453.0	6-020251	Curvette, V. Carling	16 / 10	120V / 250V
8.716-051.0	6-020252	Curvette, 2-Pos	20 / 15	125V / 250V
8.716-052.0	6-020253	Curvette, 3-Pos	16 / 10	125V / 250V
9.802-451.0	6-020240	Carling, Green Light, 2-Pos	15 / 10	125V / 250V
9.802-452.0	6-020241	Carling, Red Light, 3-Pos	15 / 10	125V / 250V
8.716-037.0		Rocker	15 / 10	125V / 250V



### DIGITAL MONITOR

Provides accurate testing and monitoring of electrical outlets and systems.



- Constantly monitors voltage and frequency indicated
- Potential improper polarity and ground wiring
- Accurate testing and monitoring of all AC power sources
- RMS Voltage and Frequency Meter
- Multi-tone Fault Alarm
- Hands-Free Auto Reset
- Advanced Microelectronics
- One-Button Operation

PART NO.	DESCRIPTION
8.749-947.0	Digital Monitor

### ADJUSTABLE THERMOSTAT

With panel-mount controls



- PSI: 4000
- Temperature: 302° F
- Temperature change response within ± 6° F
- Accuracy ± 2.5%
- AMP: 16, 250V
- Large, Easy-Read Dial
- Advanced Microelectronics
- One-Button Operation
- 3-1/2" immersion bulb with 60" capillary tube
- Seal, nut and 1/2" transition coupling included

PART NO.	OLD NO.	DESCRIPTION
8.712-494.0	430050	0-194° F Thermostat
8.712-497.0	430058	0-248° F Thermostat
8.904-557.0	430060	0-302° F Thermostat
8.750-096.0		Knob 150° C / 302° F

### ADJUSTABLE FLOW-THRU THERMOSTAT

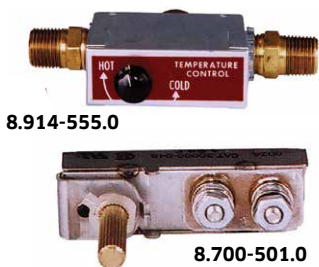

- PSI: 3000
- Adjustable Temperature: 85° - 195° F
- AMP: 10, 110V
- AMP: 5, 220V
- 1/2" Inlet, 3/8" Outlet
- Fenwall Inside
- Tension Adjusting Screw
- Stop Collar
- Ceramic Insulation
- Silver Contacts
- Stainless-Steel Case

PART NO.	OLD NO.	DESCRIPTION
8.904-555.0	430027	Thermostat
8.700-501.0	076731	Switch Only

### ON / OFF CAM SWITCH



- Legend Plate: On / Off
- Tear-Drop-Shaped Knob
- Face Plate 2-1/2" Square
- Motor Ratings:  
410202 - 1-1/2 HP / 110V  
410204 - 6 HP / 240V

PART NO.	OLD NO.	DESCRIPTION
8.712-213.0	410202	20 Amp / 110V
8.712-215.0	410204	28 Amp / 240V

### INDICATOR LIGHTS



- Easy Mounts to Control Panel
- Available in 12V, 24V and 125V
- Great for remote applications

PART NO.	OLD NO.	VOLTAGE	COLOR
8.716-095.0	6-02053	125V	Red
9.802-455.0	6-020530	125V	Green
8.716-408.0	6-050413	125V	Amber
9.803-651.0	6-0399	24V	Red
9.803-652.0	6-03990	24V	Green
8.716-097.0	6-02059	12V	Red
9.802-456.0	6-025090	12V	Green

### BREAKER SWITCHES



PART NO.	OLD NO.	DESCRIPTION	PHASE
8.716-067.0	875971	7.5 HP, 230V, 1400	1PH
8.716-068.0	875972	7.5 HP, 230V, 1400	3PH
8.716-069.0	875973	7.5 HP, 460V, 1400	3PH
8.716-073.0	950198	10A / 460V, 900	3PH
8.716-074.0	950191	12A / 480V	3PH
8.716-075.0	950208	15A / 18.8V, 800	3PH
8.716-076.0	950204	20A / 277V, 900	3PH
8.716-070.0	875618	25A / 250V, 2255	3PH
8.716-077.0	950200	30A / 277V, 900	1PH
8.716-066.0	875953	40A / 230V, 1070	1PH

### VINYL ELECTRICAL TAPE



- Premium Grade, 7 mil
- UL-Approved

PART NO.	OLD NO.	DESCRIPTION
8.704-706.0	118910	Roll 3/4" x 60'

## WIRE LOOM, FOR WIRING HARNESSSES



- Protects wires from abrasion and crushing
- Controls bundles of wires and allows for multiple exits at wiring points
- "Factory-perfect" look for all machines

PART NO.	OLD NO.	DESCRIPTION
8.709-679.0	337120	1/4" ID 100' Roll
8.709-680.0	337121	3/8" ID 100' Roll
8.709-681.0	337122	1/2" ID 100' Roll
8.709-682.0	337123	5/8" ID 100' Roll

## GFCI MODULE

Not recommended for field service.



- AMP: 20 at 120V or 240V, 60 Hz
- Using 120V or 240V shop attachable module; attach your power cord length as required
- Use with 16-12 gauge SJ, SJO or SJT, 3-wire cords

PART NO.	OLD NO.	DESCRIPTION	PHASE
8.709-858.0	337642	GFCI Module	1PH
8.709-859.0	337643	GFCI Module (not pictured)	3PH

## ROMEX CONNECTORS (METAL)



PART NO.	OLD NO.	DESCRIPTION
8.709-663.0	337020	1/2" Strt. Connector
8.709-664.0	337021	3/4" Strt. Connector
8.709-660.0	337017	1/2" Lock Nut Only
8.709-661.0	337018	3/4" Lock Nut Only

## CORD CAPS / PLUGS



8.709-653.0 8.709-655.0 8.709-656.0 8.709-659.0

- Industrial-Quality
- Dead front cord caps - nylon body straight plugs and "auto-clamp" for cord
- 337013 angle plug has vinyl body and both 30A and 50A neutral leg

PART NO.	OLD NO.	DESCRIPTION	MATERIAL
8.709-653.0	337000	15A / 120V	Black Nylon
8.709-655.0	337004	20A / 120V	Black Nylon
8.709-656.0	337006	20A / 250V	Black Nylon
8.709-659.0	337013	30A-50A / 250V	Black Vinyl

## LIQUID-TIGHT STRAIN RELIEF CONNECTOR FOR CABLE, WIRE AND TUBING

Keep water-tight NEMA-4 and 4x enclosures water-tight with these unique fittings.

**Dome nut with inside taper.** As the dome nut is tightened, the seal ring grips, holding the cable wire or tuing positively in place.

**Lead-screw thread.** The dome nut can be firmly tightened due to the high strength lead-screw thread.



PART NO.	TYPE	THREAD	CORD SIZE	CORD OD	LENGTH
8.709-687.0	Dome	1/2" NPT	14/3-12/3	.230" - .470"	1.8"
8.709-688.0	Dome	3/4" NPT	14/3-12/3	.350" - .630"	2.0"
8.709-689.0	Dome	3/4" NPT	12/3-10/4	.510" - .710"	2.0"

### Plastic Jam Nuts

PART NO.	THREAD
9.802-525.0	1/2" NPT
9.802-526.0	3/4" NPT

**Clamping Splines.** Various sizes and odd-shaped cables, wires and tubing can be accommodated due to overlapping diagonally split clamping splines.



PART NO.	TYPE	THREAD	CORD SIZE	CORD OD	LENGTH
8.709-690.0	Flex	1/2" NPT	14/3-12/3	.230" - .470"	4.3"
8.709-692.0	Flex	3/4" NPT	12/3-10/4	.51" - .71"	5.2"

### Conduit

PART NO.	THREAD
9.802-448.0	Watertight Flex 1/2" x 100' Box

## GROUND FAULT CIRCUIT INTERRUPTERS (GFCI)



GFCIs protect people and equipment by interrupting potentially lethal ground circuits exceeding 6mA. The dangers of electrical shocks have been long known - GFCIs are the only real way to be safe. Most city and county codes now require GFCI protection on power cleaning equipment.

- UL-Listed
- Three Wire Circuits
- Transient Voltage Protection
- 4-6mA Ground Fault Protection
- Grounded Neutral Protection
- Mechanical Trip Indicator
- Compact Size
- Rugged Construction
- Radio Frequency Interference Suppression



PART NO.	OLD NO.	VOLTAGE	AMP	LENGTH	PLUG INCLUDED
8.709-850.0	337626	120V	15A	12'	Yes
9.802-432.0		120V	15A	36'	Yes
8.709-842.0	337607	120V	20A	12'	No
8.903-807.0	337608	120V	20A	12'	Yes
8.709-843.0	337609	120V	20A	35'	Yes
9.802-431.0		120V	20A	36'	Yes
9.802-433.0	6-010631	240V	20A	36'	Yes
9.802-434.0		240V	40A	36'	Yes
8.709-860.0	337645	240V	30A	6'	No
8.709-853.0	337632	240V	30A	6'	Yes
8.709-861.0	337647	240V	30A	12'	No
8.709-854.0	337634	240V	30A	12'	Yes
8.709-862.0	337649	240V	30A	35'	No
8.709-855.0	337635	240V	30A	35'	Yes
9.802-430.0		240V	30A	36'	Yes
GFCI Plug Without Cord					
8.709-847.0	337615	120V	15A	n/a	Yes
8.709-846.0	337614	120V	20A	n/a	Yes

Note: User-attached plug also includes the sealant necessary to attach the power cord per UL specification

### MOLDED PLASTIC FLOAT TANKS



- Molded Polypropylene
- 7 Liter Size: 13" x 5" x 6"
- 1 Gallon Size: 10" x 5" x 8"
- No holes for max flexibility
- 1 gallon tank has tight fitting lid, included
- 7 liter tank lid is snap-on and sold separately

PART NO.	OLD NO.	DESCRIPTON
8.710-026.0	343002	7-Liter Tank Only
8.710-027.0	343003	7-Liter Tank Lid
8.710-028.0	343004P	1-Gallon Tank W/Lid

### STAINLESS-STEEL FLOAT TANK



- Fully Welded and Water Tight
- 2.8 Gallon Capacity
- 12" x 9" x 6"
- 16 Gauge #303 Stainless-Steel
- 1/2" Full Coupling, Stainless-Steel Inlet / Outlet
- Convenient Mounting Tabs

PART NO.	OLD NO.	DESCRIPTON
8.710-029.0	343006	Stainless-Steel Float Tank
8.710-034.0	343016	Stainless-Steel Lid

### FRAMES, DIRECT DRIVE & BELT DRIVE



- Heavy-duty aluminum that is more corrosion-resistant than steel
- 10" flat-free tire for better reliability
- Integrated nozzle holders
- Available in both direct and belt drive models

PART NO.	DESCRIPTON
8.924-399.0	Aluminium Frame, DD CW
8.924-400.0	Aluminium Frame, 270 and 390 AL DD CW

### REPLACEMENT FUEL CAP

- Fits 9 Gallon Diesel Fuel Tank (8.710-142.0)
- Fits Fuel Tanks (8.751-294.0, 8.751-296.0, 8.751-293.0)

PART NO.	DESCRIPTON
8.751-449.0	Replacement Fuel Cap for Fuel Tanks

### FUEL TANK, 9 GALLON DIESEL



- Strap or Bolt Mount (4 / 5/ 16" Inserts in Bottom)
- Metal Inset 3/8" Inlet / Return Lines
- Black, Crosslinked PE
- Vented Fuel Cap
- Filler neck doesn't extend beyond tank wall
- Compact Size: 19-3/4" L x 12" W x 10-1/2" H

PART NO.	OLD NO.	DESCRIPTON
8.710-142.0	344735	9-Gallon Fuel Tank - Plastic

Note: Includes Fuel Cap

### FUEL TANKS



8.751-293.0



8.751-294.0

- EPA / CARB-Compliant
- Seamless one-piece construction of marine grade, UV-protected polyethylene
- Built-in reserve (when gauge reads "empty", tilt to access additional fuel)
- Two-stage click when closed fuel cap
- 90° fuel withdrawal fitting
- Easy-to-read sight gauge
- Four shapes and capacities from which to choose

PART NO.	GALLONS	LENGTH	WIDTH	HEIGHT
8.751-294.0	6	21.18"	13.5"	10"
8.751-296.0	12	20.375"	13.75"	14.75"
8.751-293.0	12	24.25"	18"	11"

### RUBBER PARTS



9.802-064.0



9.802-066.0



8.706-557.0



9.802-067.0



9.802-069.0

PART NO.	OLD NO.	DESCRIPTON
9.802-064.0	859815	Grommet, Nozzle Holder
8.706-557.0	616018	Bellows, Leg Boot
9.802-067.0	830587	Bumper Pad, Engine
9.802-069.0	691877	Handle Grip
8.706-745.0	829620	Plug, Hole Plastic
9.803-046.0	784446	Mount, Rubber Vibration
8.706-525.0	891040	Mount, Rubber Vibration 203 / 8-25 Std
8.706-553.0	891041	Mount, Rubber Vibration 60 Duro
8.706-524.0	891048	Mount, Rubber Vibration 1-3/8" Dia x 3/4"
8.706-556.0	891051	Mount Vibration
9.802-066.0		Pad, Soft Rubber

**FUEL CAPS**



- For Gas or Diesel Fuel Tanks
- Fits Standard 2-1/4" Fuel Necks

PART NO.	OLD NO.	DESCRIPTION
8.701-700.0	091520	Fuel Cap with Gauge 10"

**BATTERY BOXES WITH COVER, MARINE STYLE**

Protect batteries on pressure washers, boats or other industrial equipment.



- Attractive Molded Polypropylene
- Complete with hold-down cleats and strap for cover
- Small: 8-1/2" L x 6" W x 8-1/2" H
- Large: 11-1/4" L x 7-3/4" W x 10-3/4" H

PART NO.	OLD NO.	DESCRIPTION
9.802-090.0	306625	Small Box
9.802-075.0	306627	Large Box

**FLAT-FREE TIRES**

Flat-free tires provide the bounce and load handling characteristics similar to an air filled tire - with the benefit of never going flat. Flat-free tires are lightweight, non-marking and come mounted on a heavy-duty steel rim with shielded ball bearings. Not for highway use.



- Heavy-Duty Steel Rim
- Non-Marking
- 4" Steel Rim: Max Load 300 lbs
- 12" Steel Rim: Max Load 375 lbs

PART NO.	DESCRIPTION
8.711-898.0	Wheel and Tire Assembly, 4" Steel Rim
8.754-435.0	Wheel and PU Tire Assembly, 12" Steel Rim

**PLASTIC DIP TUBE ASSEMBLY**



- Rubber bushing seal ordered separately
- New Style Plastic Dip Tubes

PART NO.	DESCRIPTION
8.706-494.0	Plastic Dip Tube Assembly, 7.5" Long
8.706-495.0	Plastic Dip Tube Assembly, 12" Long
8.706-496.0	Plastic Dip Tube Assembly, 17.75" Long
9.802-053.0	Rubber Bushing, Fuel Line

**COMPLETE WHEELS**



**8.711-901.0      9.802-270.0      9.802-271.0      8.712-762.0**

- High-Quality Pneumatic and Semi Pneumatic
- Fits 5/8" Shaft

PART NO.	OLD NO.	DESCRIPTION
8.711-901.0	4-0304	10" Mag
9.802-270.0	4-0303	10" Steel Rim W/Tube
8.754-435.0	4-0307	13" Steel Rim
8.712-762.0	480115	10" White Steel Rim, 3/4" Hub Tubeless
8.711-905.0	4-03071	6" Steel Rim Foam Filled
8.711-921.0		6" Tube Only
8.712-767.0		10" Tube Only
9.802-274.0		10" x 2-3/4" Hard Rubber Wheel
8.711-908.0		3" Gray Caster Wheel



**Interchangeable Bearings**

PART NO.	OLD NO.	DESCRIPTION
8.700-484.0	076504	5/8" Bore Bearing
8.700-486.0	076505	3/4" Bore Bearing
8.700-485.0	076504P	5/8" Nylon Bearing

**Hub Caps and Collars**

PART NO.	OLD NO.	DESCRIPTION
8.700-183.0	071625	3/4" Hub Cap
8.700-184.0	071627	5/8" Hub Cap
9.802-782.0		5/8" Bore Shaft Collar

**MISCELLANEOUS PARTS**

PART NO.	DESCRIPTION
8.719-064.0	Chassis Knob 5/16" Thread, Black
9.802-066.0	Soft Rubber Foot Pad
8.932-992.0	Vibration Isolator 3/8"



## A+ SURFACE CLEANER



Fast, even cleaning for large flat surfaces. Quickly cleans concrete, asphalt, and it removes grime and deposits from tennis courts, ramps and decks. Also great for factory and semi-trailer floors and drive-thrus. Cleans better and faster than a spray wand alone, with no stripping. Use with hot or cold water and handles water up to 212° F to disinfect bathrooms and kitchens. Safety lock prevents accidental spraying.



- Two spinning nozzles 'floats' cleaner above the ground
- Circular design allows a zero wall clearance
- Stainless-Steel Housing and Handle
- 3/8" male quick connector plugs into your pressure washer's hose
- Reduces overspray on walls, landscaping and operator
- Comes with two #2.0, 1/8" nozzles (for machines up to #4.0 nozzles), 250 nozzles rated up to 8.0 GPM and 400 PSI
- Requires at least 3.0 GPM, 2000 PSI

PART NO.	DESCRIPTION
8.753-572.0	A+SC21 Rotary Surface Cleaner, 21"
8.753-573.0	A+SC24 Rotary Surface Cleaner, 24"
8.753-597.0	Swivel for 21" and 24"

## WHISPER WASH FLAT SURFACE CLEANERS

- PSI: 2000 - 4000
- RPM: 2500
- Saves labor, fuel and water
- Eliminates overspray and zebra striping
- Quick Connection
- Use with conventional pressure washers
- Use with Cold or Hot Water
- Balanced Spray Bare

### Applications

- Service Stations
- Public Facilities
- Driveways
- Pool and Patio Decks
- Restaurants
- Sidewalks
- Warehouse Floors
- Gondolas
- School Yards
- Loading Docks
- Stadiums
- And lots more!!!
- Parking Lots
- Marina Docks

### The "Maxima 36"

- GPM: 4-10
- RPM: 2500
- Temperature: 212° F
- Portable Breakaway Handle
- Dimensions: 36" Cover, 77" Handle
- Weight: 37 lbs
- Uses 1/4" Nozzle

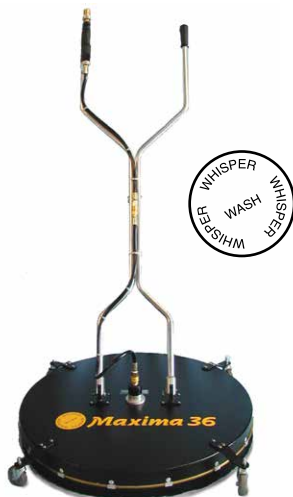

PART NO.	OLD NO.	DESCRIPTION
8.710-089.0	343636	Maxima 36

## WHISPER WASH FLAT SURFACE CLEANERS, CONTINUED



### Ground Force

- GPM: 4.0 - 10.0
- Temperature: 212°F
- Flip and Fold Handle
- Choice of two or four nozzles
- Rebuildable Swivel
- Uses 1/4" Nozzle
- Dimensions: 24" x 60" x 9"
- Weight: 29 lbs

PART NO.	OLD NO.	DESCRIPTION
8.710-076.0	343608	Ground Force



### The "Big Guy"

- GPM: 4.0 - 10.0
- Temperature: 212°F
- Powder-Coated Aluminum Housing
- Oversized, self-lubricating twin thrust bearings
- Choice of two or four nozzles
- 10" Pneumatic Tires, 4" Caster
- Craft with durable stainless-steel and aircraft aluminum
- Uses 1/4" Nozzle
- Dimensions: 28" x 44" x 12"
- Weight: 48 lbs

PART NO.	OLD NO.	DESCRIPTION
8.710-074.0	343606	Whisper Wash Big Guy 2 Nozzles
8.710-075.0	343607	Whisper Wash Big Guy 4 Nozzles
8.750-604.0	092110	Swivel, Complete Big Guy and Classic
8.701-879.0	092105	Repair Kit, Seal, Big Guy and Classic
8.701-874.0	092101	Spraybar, 4 Nozzle, Big Guy
8.701-876.0	092102	Spraybar, 2 Nozzle, Big Guy

### The Classic

- GPM: 4.0 - 10.0
- Temperature: 212°F
- Portable Breakaway Handle
- ABS Housing
- 2" Nylon Brush
- Uses 1/4" Nozzle
- Dimensions: 19" x 77" x 12"
- Weight: 28 lbs



PART NO.	OLD NO.	DESCRIPTION
8.710-073.0	343605	Whisper Wash Classic
8.750-604.0	092110	Swivel, Complete Big Guy and Classic
8.701-879.0	092105	Repair Kit, Seal, Big Guy and Classic

## WHISPER WASH FLAT SURFACE CLEANERS, CONTINUED



### The Ultra Clean WW

- GPM: 3.0 - 6.0
- Temperature: 185°F
- RPM: 2500
- Powder-Coated Handle
- Four 3" Casters
- Uses 1/4" Nozzle
- Dimensions: 19" x 43" x 9"
- Weight: 23 lbs

PART NO.	OLD NO.	DESCRIPTION
8.710-072.0	343604	Whisper Wash Ultra Clean WW



### The Ultra Clean HC

- GPM: 3.0 - 6.0
- Temperature: 185°F
- ABS Housing
- 2" Nylon Brush
- Powder-Coated Handle
- Uses 1/4" Nozzle
- Dimensions: 16" x 43" x 9"
- Weight: 19 lbs

PART NO.	OLD NO.	DESCRIPTION
8.710-071.0	343603	Whisper Wash Ultra Clean HC

### Repair Kits

PART NO.	OLD NO.	DESCRIPTION
8.701-879.0	092105	Seal Kit: Classic, Big Guy and Ground Force
8.701-882.0	092108	Seal Kit: Ultra Clean
8.701-883.0	092109	Complete Swivel Kit: Ultra Clean
8.750-604.0	092110	Complete Swivel Kit: New Style
8.707-653.0	251119	2.5 x 25°, 1/4" Nozzle Fits All Models

## MOSMATIC GUN SWIVEL



Mounts to your high-pressure gun or lance for an easy turning, low-maintenance gun swivel.



- PSI: 4000
- Temperature: 250°F
- RPM: 30

PART NO.	OLD NO.	DESCRIPTION
8.712-467.0	421057	1/4" MPT, 1/4" FPT Gun Swivel
8.712-466.0	421056	3/8" MPT, 3/8" FPT Gun Swivel

## MOSMATIC SURFACE CLEANERS AND DUCT CLEANER



### Turbo Surface Cleaner

Delivers high-pressure performance with low maintenance for any hot or cold pressure washer. Completely stainless-steel design makes this the toughest surface cleaner available in the pressure-cleaning market.

Swiss-engineered with high RPM swivel features reinforced self-lubricated stainless-steel ball bearings and dual spring-based carbide seal bushings for long-lasting operation under tough conditions.



- PSI: 4000
- Temperature: 250°F
- Weight: 6.5 lbs

Ideal for pressure washer contractor to clean walls, ceilings, public facilities, tile floors and other hard-to-reach areas. Uses 1/8" meg 1503 nozzles.

- PSI: 4000
- Temperature: 250°F
- Inlet Ports 3/8" NPTF
- Weight: 2 lbs

### Duct Cleaner

Designed as an accessory for use with high-pressure pumps or pressure washers. Cleans ducts, chutes, vents, restaurant exhausts, tanks, etc.



- PSI: 4000
- Temperature: 250°F
- 12" Stainless-Steel
- Weight: 9 lbs

Self-rotating and feeding stainless-steel triple bearing system for constant easy turning. Nozzle holders are 1/8" NPTF. Nozzles are sold separately.

### 12" Surface Cleaner

Designed for effortless cleaning of small areas, including walls and angled surfaces. High RPM swivel with integrated toggle joint and adjustable tension system.



PART NO.	OLD NO.	DESCRIPTION	PSI
8.712-284.0	411171A	Turbo Cleaner, 8"	4000
8.712-285.0	411172	Toggle Joint KGK	4000
8.712-280.0	411156	Duct Cleaner TXR-2s, Adjustable	4000
8.712-279.0	411155	Duct Cleaner TXR-2s, Fixed	4000
8.749-911.0		Surface Cleaner, 12"	4000

## SURFACE CLEANER NOZZLE RECOMMENDATION

Determine the correct nozzle size for the pressure washer being used with the surface cleaner. Never use a smaller size nozzle as this will prematurely wear out the unloader valve on the pressure washer. The Legacy Undercarriage Cleaner and A+ Surface Cleaners come supplied with nozzles, for other surface cleaners, nozzles must be purchased separately. Threaded nozzles are listed on pages 45-46 of the catalog, to determine your pressure washer nozzle size refer to chart on page 35. Contact your RSM on other sizes for surface cleaner spray bars that use 4 nozzles or other sizes.

PRESSURE WASHER NOZZLE SIZE		15° X 1/4" MPT	25° X 1/4" MPT
#3.5 and #4.0	2 each	#2.0	#2.0
#4.5 and #5.0	2 each	#2.5	#2.5
#5.5 and #6.0	2 each	#3.0	#3.0
#6.5 and #7.0	2 each	#3.5	#3.5
#7.5 and #8.0	2 each	#4.0	#4.0

## MOSMATIC ROOF CLEANER

Industrial-quality tool specially designed for efficient, high-pressure roof cleaning while keeping the operator in a safe area.



- PSI: 4000
- Temperature: 250°F
- Weight: 31.9 lbs
- 21"
- Pressure Gauge
- Ball Valve
- Adjustable Wheels (Height and Width)
- Safety eye connection for rope or cable
- Two 1/8" Nozzle Sold Separately

PART NO.	DESCRIPTION
8.749-910.0	Mosmatic Roof Cleaner

## UNDERCARRIAGE CLEANER



- Stainless-steel rotating assembly built to withstand pressures up to 4000 PSI and 250°F
- 5.5" Required Clearance
- Four Nozzles: (2) 0° #2.0, (2) 25° #2.0
- No more crawling under a vehicle
- Simply connect to your hot or cold water pressure washer
- Easy to handle and maneuver
- Removes road grime, fuel and oil contaminants
- Removes Snow Sludge and Ice
- Provides a clean, working environment for technicians

PART NO.	DESCRIPTION
8.749-303.0	Undercarriage Cleaner

## "CYCLONE" ROTARY FLAT SURFACE CLEANER



- PSI: 2000 - 4000
- GPM: 4.0 - 6.0
- Up to 5.0 GPM
- Temperature: 200°F
- Polyethylene Housing
- Collapsible Handle
- Pneumatic Tires
- 20" Diameter Surface Cleaning
- Weight: 35 lbs

PART NO.	OLD NO.	DESCRIPTION
8.710-073.0		Classic Rotary Surface Cleaners (Yellow)
8.710-074.0	630853	"Big Guy" Rotary Surface Cleaners
8.903-608.0	30-587	"Cyclone" Surface Cleaners

## OIL-FIRED HOT BOX



Add hot water cleaning economically! Portable water heater add-on for existing cold water pressure washers. Quick Connect to cold water washer, supply fuel and power to Euro-Heat for hot water cleaning applications - USE ONLY WHEN NEEDED and keep the convenience of the portable cold water washer.



- PSI: 3000
- Quick hookup: 3/8" QC Inlet / Outlet
- Easy service access to burner parts
- Efficient vertical combustion configuration
- Diesel, Kerosene, #1 Heating Oil
- 10" Easy-roll Tubed Pneumatic Tires
- 5-Gallon Plastic Fuel Tanks
- Compact Size: 37" W x 27" L x 39" H
- 36' Ground Fault Interrupter Plug
- Thermostat Temperature Control

PART NO.	OLD NO.	DESCRIPTION
1.103-910.0	HR-5030D	5 GPM / 3000 PSI, 120V

**GOFF'S CURTAIN WALLS**

Build a Power Wash Cell to meet your needs. Goff's Curtain Walls™ increase useable floor space while controlling overspray, contaminants, climate and noise levels. Curtain Walls™ glide easily on steel track and dual-wheeled rollerhooks. Made from a combination of 14oz., heavy-duty, reinforced vinyl and double-polished 20-mil clear PVC material. Reinforced hems and chain-weighted lower hems add durability. Hook and loop fasteners on side hems attach to adjacent panels. Meet NFPA-701 requirements for flame retardancy. Curtains are also rot and mildew resistant. Standard model has a white vinyl top, clear PVC center and blue vinyl bottom.

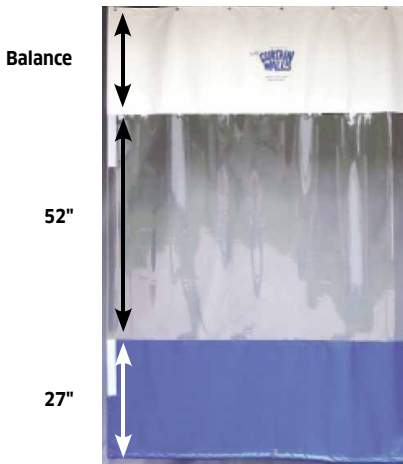

- #2 Brass Tooth Grommets on 1' Centers
- 4oz. Reinforced Vinyl White Top Section
- All Seams Double-Locked Stitched
- Hook and Loop Fasteners allow adjacent panels to be easily attached to one another
- 20 mil. Double-Polished Clear Window
- All sections joined together using mildew with rot resistant thread
- 4oz. reinforced colored vinyl section (your choice of over 12 different colors)
- Chain-weighted lower hem

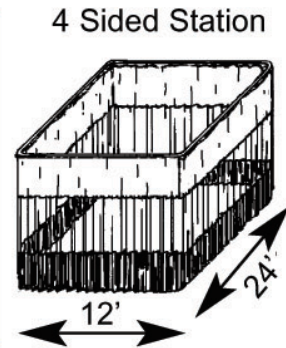
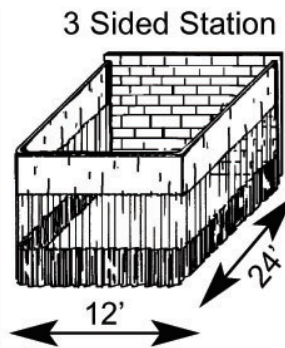
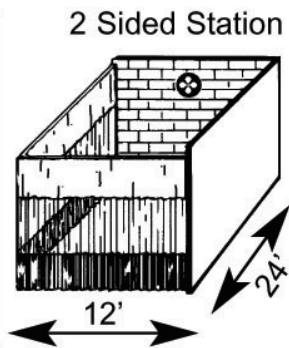
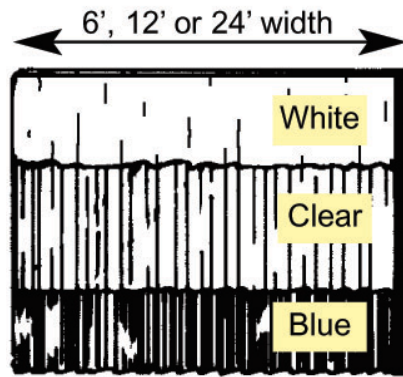

PART NO.	OLD NO.	DESCRIPTON	PSI
Single			
9.841-694.0	681133	6' Width x 12' High	1500
8.717-007.0	681083	12' Width x 8' High	1500
8.717-008.0	681084	12' Width x 9' High	1500
8.717-009.0	681086	24' Width x 10' High	1500
8.739-486.0	681087	24' Width x 12' High	1500

Includes Hardware, Track and Rollers (White Top, Clear Center and Blue Bottom Panel) All 2-, 3- and 4-Sided Stations are 12' Wide x 24' Long (See Diagram Above).

Other Sizes Available - Call for Details.



## SANDBLAST KIT, CARBIDE NOZZLE INDUSTRIAL GRADE



A Venturi orifice creates a uniform blast pattern, doubles sand velocity and produces up to 45% more work with 20% less sand.



- Max Working Pressure PSI: 5500
- GPM Max: 10.0
- Temperature: 200°F
- Weight: 10 lbs
- Nozzle Tip Sold Separately

PART NO.	OLD NO.	DESCRIPTION
8.701-485.0	084079	Sand Blast Kit DWSDBTk

## PROFESSIONAL SANDBLAST HEAD



- PSI: 3500
- GPM: 10.0
- Temperature: 200°F
- Long-Wearing Carbide Sand Nozzle
- 1/4" FPT Water Inlet
- Sand Probe Weight: 6oz.
- Head Weight: 13oz.
- Length: 16"

NOZZLE SIZE	PART NO.	OLD NO.
3.5	8.711-242.0	391631
4.0	8.711-243.0	391632
4.5	8.711-244.0	391633
5.0	8.904-403.0	391634
5.5	8.711-245.0	391635
6.0	8.904-404.0	391636

PART NO.	OLD NO.	DESCRIPTION
8.711-247.0	391640	Sand Probe
8.901-264.0	121041	1/2" ID Polybraid Tubing, 25'

## SELF SERVE UNDERBODY WAND ASSEMBLY



Ideal for rinsing the undercarriage of cars and trucks. Connect directly to a pressure washer gun or Inace. Lightweight, the underbody wand assembly roll seasily giving the operator a long reach.



- PSI: 3000
- Temperature: 300°F
- 1/4" Inlet
- Non-weeping
- Uses three MEG Nozzles
- Stainless Steel

PART NO.	DESCRIPTION
8.755-257.0	Self Serve Underbody Wand Assembly

## SANDBLAST NOZZLE TIPS



- Replacement Tips for Sandblaster Kit (Part No. 8.701-485.0, Original Part No. 084079)
- Use 1/4" Meg 5" Spray Tip

PART NO.	OLD NO.	DESCRIPTION
8.707-668.0	251159	4.0 x 5° Tip
8.707-685.0	251198	5.0 x 5° Tip
8.707-696.0	251221	5.5 x 5° Tip
8.707-701.0	251237	6.0 x 5° Tip
8.707-709.0	251256	6.5 x 5° Tip

## MAT CLAMP



- Hang floor mats, scrubber pads, rugs, rags, coveralls, etc.
- For close-up pressure washing and drying

PART NO.	OLD NO.	DESCRIPTION
8.709-071.0	823885	Aluminum Spring Action



SEWER / TUBE CLEANING NOZZLES



The reverse jets on the fixed and rotary nozzles pull the hose through the tube or sewer line and blast debris from line or tube walls.

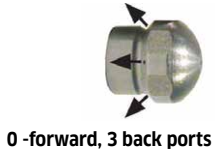

0 -forward, 3 back ports



1 -forward, 4 back ports



1 -forward, 3 back ports

- PSI: 4200
- Physically small for cornering ability
- Corrosion-resistant stainless-steel construction
- Orifice size indicated on non-rotating styles
- Backward ports drive the nozzle forward and flush debris
- Forward ports blast into pipe and breaks up clogs and debris
- Rotating style adds extra agitation and surface cleaning

PART NO.	OLD NO.	NOZZLE	ORIFICE SIZE	O.D.	PORTS
Non-Rotating Sewer Nozzles					
8.710-875.0	373024	1/8"	4.5	.580"	0-Forward, 3 Back
8.710-874.0	373023	1/8"	5.5	.580"	1-Forward, 3 Back
8.710-878.0	373027	1/4"	4.5	.730"	1-Forward, 3 Back
8.710-876.0	373025	1/4"	5.5	.730"	1-Forward, 3 Back
8.710-877.0	373026	1/4"	6.0	.730"	1-Forward, 4 Back
8.710-880.0	373029	1/4"	7.5	.730"	1-Forward, 4 Back
8.710-879.0	373028	1/4"	8.0	.730"	1-Forward, 3 Back
8.710-881.0	373032	1/4"	12	.730"	1-Forward, 3 Back
8.710-885.0	373038	3/8"	4.0	.920"	1-Forward, 3 Back
8.710-884.0	373037	3/8"	5.5	.920"	1-Forward, 3 Back
8.710-886.0	373039	3/8"	8.5	.920"	1-Forward, 4 Back
8.710-883.0	373036	3/8"	12	.920"	1-Forward, 4 Back
8.710-882.0	373035	3/8"	14	.920"	1-Forward, 4 Back



0 -forward, 3 back ports

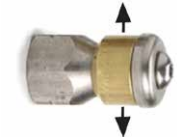

0 -forward, 2 side ports

- PSI: 4000
- Rotating Sewer Nozzle
- Adds Extra Agitation
- Back Jet Only

PART NO.	OLD NO.	ROTATING NOZZLE	ORIFICE SIZE	PORTS
Rotating Sewer Nozzles				
8.710-899.0	373062	1/8"	5.5	0-Forward, 3 Back
8.710-898.0	373061	1/4"	5.5	0-Forward, 3 Back
8.710-900.0	373064	1/4"	8.0	0-Forward, 3 Back
8.710-887.0	373040	1/4" Duct Cleaner*	5.5	0-Forward, 2 Side

\*Duct Cleaner jet to sides instead of reverse

STAINLESS-STEEL SEWER NOZZLES



- PSI: 4100
- Corrosion-Resistant Stainless-Steel
- One Forward Orifice
- Three Rear Orifices

PART NO.	OLD NO.	FPT	SIZE
8.710-905.0	373075	1/8"	5.0
8.710-906.0	373076	1/8"	5.5
8.710-907.0	373077	1/8"	6.0
8.710-908.0	373078	1/4"	6.5
8.710-909.0	373079	1/4"	7.0
8.710-910.0	373080	1/4"	9.5

WATER BROOM 16"



- PSI: 4000
- Fits Any 1/4" Wand
- Requires (4) 1/4" Nozzles and Wand

PART NO.	OLD NO.	DESCRIPTION
8.710-082.0	343615	Water Broom 16"

## DUAL-CHEMICAL SYSTEMS



- New deep-ribbed yellow casing, stays flexible even in cold temperature
- Hose assembly complete with gun and amphenol connectors pre-wired
- Fully-compatible with Power Blaster, Two-Step, Chemex and most other cold water dual-chemical systems

PART NO.	OLD NO.	DESCRIPTION
Complete Hose Assembly		
8.709-044.0	285116	80' R2 Electric, 5 Wire
Lance Attachment Parts		
8.709-049.0	285136	Female Receiver
8.709-050.0	285137	Male Lance Swivel
8.709-051.0	285138	Retainer Nut
Remote Gun / Hose Parts		
8.709-048.0	285135	Gun Housing
8.709-053.0	285139	Switch P/B
8.709-054.0	285140	Switch, Chemical
8.709-056.0	285142	Switch Plate
8.903-083.0	285144	O-ring, Nipple (Two Required)
8.903-084.0	285145	O-ring, Nipple (Bags of 50)
8.709-060.0	285175	Swivel Adapter
8.709-061.0	285177	Cord Grip
8.709-064.0	285187	Switch - Push Button Trigger
8.709-065.0	285189	Toggle, DPDT (Trig) On / Off / On

## SEWER HOSE

Super Flexible Sewer Line Hose. Hose and couplings have small outside diameter, allowing hose and nozzles to fit through sewer line. Sewer line has Super Tough poly-ether cover over ultra-flexible nylon tube. 1/8" sewer nozzle and hose will operate through many 1-1/2" lines.



- Temperature: 160°F
- Nylon tube, polyether cover

PART NO.	OLD NO.	DESCRIPTION
1/8" Hose - 4800 PSI, 1/4" Inlet, 1/8" Outlet		
8.705-601.0	150960	1/8" x 25'
8.705-602.0	150963	1/8" x 50'
8.705-603.0	150964	1/8" x 100'
1/4" Hose - 2600 PSI, 1/4" Inlet, 1/4" Outlet		
8.705-607.0	150968	1/4" x 50'
8.705-608.0	150970	1/4" x 100'
1/4" Hose - 4400 PSI, 1/4" Inlet, 1/4" Outlet		
8.705-610.0	150972	1/4" x 50'
8.705-611.0	150973	1/4" x 100'
8.705-613.0	150975	1/4" x 200'

## FOOT-CONTROLLED PRESSURE VALVE



Operators of sewer and tube cleaning equipment need both hands free to feed or retract the hose in the sewer line. Foot-operated valve allows hands-free control.



- PSI: Up to 5000
- GPM: 12.0
- Inlet 3/8", Outlet 1/4"
- Brass Body, Stainless-Steel Valve

PART NO.	OLD NO.	DESCRIPTION	PSI
8.710-134.0	344200	Sewer Cleaner Foot Valve	3000
8.709-972.0	342024*	Foot Valve W/ ST-2305	5000
8.701-657.0	089006	Repair Kit - Foot Valve	
8.701-673.0	089850	Repair Kit ST-2305	
8.711-526.0	4-0193	Kit, 25' Hose, #4.5 Nozzle, Foot Valve	

\*Heavy gauge steel construction for durability and stability

## ST-36 PIT BOSS SLUDGE SUCKER



Sludge Sucker uses a high-pressure water stream (1000-3000 PSI) to suck the sludge off the bottom of pits or tanks and eject it through a 1-1/2" (15' long) hose to a disposal tank.

The base unit attaches to the end of a pressure washer lance with a quick coupler for extension to the bottom of the pit. Uses a 0° tip for suction / power ejection.



- Easy to change for different plumbing system flows and pressures
- Uses Standard 1/4" MPT Nozzle

PART NO.	OLD NO.	DESCRIPTION
8.711-112.0	376137	ST-35 Pit Boss, 5.5 Nozzle, 15' Hose
8.711-110.0	376126	Base Unit Only

\*W/O Hose, Nozzle or Quick Coupler (3/8" Inlet Port)

## DRUM PUMPS

Siphon liquids from higher to lower levels. Simply pump the bellows a few times to prime and start flow. Loosen air lock to stop.



- Drum pump fits 15-, 30- and 55- gallon drums
- Fit 2" Bung Opening
- Excellent for alkaline and acidic chemicals, diesel fuel and oils
- Not for Use with Solvents

PART NO.	OLD NO.	DESCRIPTION
8.704-698.0	118429	Red Hex Head, Heavy-duty
8.704-696.0	118423	Red Head, Standard-duty
8.704-694.0	118420	Pail Pump, 5 Gallon

**FIBERGLASS "SUPER HANDLES"**



- Tough, durable, lightweight
- No cracking, splintering
- No kinks, dents
- Safer around electrical hazards
- Super heavy-duty aluminum alloy threads
- Easy-twist cam lock extension
- Standard 3/4" Acme thread fits: brooms, brushes, utility tools
- Optional reduction adapter for 3/4" to Acme standard

PART NO.	OLD NO.	DESCRIPTION
Super Handles		
8.709-306.0	306864	48" Length (4')
8.709-307.0	306865	60" Length (5')
8.709-308.0	306866	72" Length (6')
Super-Extension Handles		
8.709-309.0	306868	4' to 8' Extension
8.709-310.0	306869	6' to 12' Extension
8.709-311.0	306870	8' to 16' Extension
8.700-308.0	075271	Threaded Adapter

**DRUM / TANK PUMP, CRANK TYPE**

Chemical-resistant, lightweight pump, ideal for dispensing chemicals, pesticides and oils. Polypropylene for most alkalis, dilute acids, pesticides and most oils and solvents. Ryton for extremely aggressive acids, aromatic and aliphatic hydrocarbons.



- 11 oz per revolution
- 6.0 GPM at 70 RPM
- Viton seals
- Polypropylene gasket
- Outlet 3/4" barb two-piece
- 2" bung adapter
- 47" suction tube
- Weight: 2.6 lbs

PART NO.	OLD NO.	DESCRIPTION
8.704-700.0	118435	Polypropylene Pump, Standard
8.704-701.0	118438	Ryton Pump, Deluxe
8.700-526.0	076970	Replacement Handles

**BRUSHES**

Rotating brush, natural bristle (soft) used for painted surfaces. Nylon bristle (stiff) used for removing scum and grime on fiberglass boats, etc.



- Internal Nozzle = Size 20
- GPM: 8.0

PART NO.	OLD NO.	DESCRIPTION
Brush Unit Complete		
8.709-312.0	306925	Natural
8.709-314.0	306935	Nylon
Replacement Brushes		
8.709-313.0	306927	Natural
8.709-316.0	306937	Nylon



- Truck Wash Brush**
- Flag-Tipped
  - Soft Bristle
  - Acme thread for Super Handles or Broom Handles

PART NO.	OLD NO.	DESCRIPTION
8.709-298.0	306800	2-1/2" Bristle W/Bumper x 10"
8.709-303.0	306818	2-1/2" Bristle x 18"
8.709-304.0	306824	2-1/2" Bristle x 24"
8.709-305.0	306860	60" Flow Thru Lance*

\*With Acme Thread and Garden Hose Attachment



- Not a Flow Thru
- Excellent chemical resistance
- Use with threaded handle

- Deck Scrub Brush - Over / Under**
- Trimmed fro cleaning hard-to-reach areas
  - Stiff polypropylene bristle for aggressive cleaning
  - Unique heavy-duty scrub brush with multi-level / angle
  - 10" molded polypropylene foam block does not warp or absorb water

PART NO.	OLD NO.	DESCRIPTION
8.709-302.0	306812	Deck Scrub Brush



- Tractor Brush - Soft for gentle cleaning of fine finishes.**

PART NO.	OLD NO.	DESCRIPTION
8.709-298.0	306802	Flag Tip Window 10"

**DRUM TOOL ACCESSORIES**

The indispensable tools.



8.712-534.0



8.704-689.0



8.704-692.0



8.704-691.0

PART NO.	OLD NO.	DESCRIPTION
8.712-534.0	449339	Drum Plug Wrench
8.704-689.0	118400	Lid-Off
8.704-691.0	118404	Funnel, 7" x 10"
8.704-692.0	118407	3/4" Faucet
8.704-693.0	118408	2" Faucet

### COMPACT FOAMER



Generates a high-density clinging foam for extended dwell-time to increase chemical action.



- PSI: 2500
- GPM: 1.0 to 5.0
- Temperature: 195°F
- Stainless-steel, aluminum and brass
- 5" long, 1" diameter
- 4 and 6.5 nozzle included

PART NO.	OLD NO.	DESCRIPTION
8.903-998.0	344022V	1/8" F Inlet
8.903-999.0	344023V	1/4" F Inlet

Note: Most cleaning chemicals perform best when applied at 120° - 150° F and can be applied as a foam by adding a foaming agent. See your chemical supplier to obtain the correct product

### FOAM CANNON

The ideal Foam Generator Application Accessory meters the foaming chemical for customized foam type and applies the foam to match the application.



- PSI Max: 3000
- GPM Max: 4.8
- Temperature: 176°F
- Brass meter valve
- High-impact, glass filled body
- Stainless-steel foam turbulator
- 1/4" FPT lance connect
- Stainless-steel 1.5mm orifice (#5.5 nozzle equivalent)

PART NO.	OLD NO.	DESCRIPTION
8.710-125.0	344030	Foam Cannon / Injector
8.710-126.0	344032	Foam Cannon / Injector / Bottle
8.704-222.0	113011	Replacement Turbulator Screen

### AIR-POWER SPRAYERS



- Pump-up style
- Heavy-duty plastic sprayers for chemical applications
- Both models have Adj. nozzle - from mist to solid stream
- 2 gallon unit has 2' hose and hand trigger
- Excellent chemical resistance
- Locking hand pump handle serves as carrying handle

PART NO.	OLD NO.	DESCRIPTION
8.704-703.0	118842	Thumb Button 3 Pint
8.704-702.0	118835	2-Gallon Sprayer

### FOAM JET KIT



Long-distance foam applicator. Shoots over 20 feet of dense foam. Suction at 30 feet of height. Variable spray pattern.



- PSI: 5000
- GPM: 5.6
- Temperature: 140°F
- 14" Inlet
- 33' Tube

PART NO.	DESCRIPTION
8.750-296.0*	Kit, Foam, Jet, 5000 PSI, 5.6 GPM
8.750-429.0	Kit, Repair, Foam Jet O-rings / Stainless-steel Filter
8.750-430.0	Kit, Repair, Foam Jet, Hose, Valve, Filter

\*Includes tubing and fittings as shown

### LAFFERTY AIRLESS FOAM KIT



- Machined stainless-steel construction
- Stainless-steel chemical check valve
- 10' chemical tube with strainer
- Stainless-steel quick disconnects
- Color-coded metering tips for up to 21 dilution ratios
- 0° nozzle for increased foam-throw distance

PART NO.	FLOW RATE @ 2000 PSI	@ 137.9 BAR
8.749-908.0 (Model 10)	4.0 GPM	15.1 LPM
8.749-909.0 (Model 20)	6.0 GPM	22.7 LPM

### ADJUSTABLE FOAMER WITH TANK

Control the foam spray angle with the variable fan nozzle.



- PSI: 2600
- GPM: 5.3
- Temperature: 140°F
- Horizontal variable fan nozzle
- Foam control adjustment knob

PART NO.	DESCRIPTION
8.710-124.0	Adjustable Foamer W/ Tank

### TEFLON® THREAD SEALING TAPE



- Big 1/2" x 520" roll
- Mil - spec #T27730

PART NO.	OLD NO.	DESCRIPTION
8.704-705.0	118905	Thread Sealing Tape

**THREAD LOCK PRODUCTS**



- Direct replacement for Loctite® and Fel-Pro™ products
- Excellent lubricant; prevents corrosion and fretting
- ND™ anaerobic adhesives are liquid materials that cure to a solid, chemical-resistant plastic state when air is not present

PART NO.	OLD NO.	DESCRIPTION	LOCTITE® EQUIV	BOTTLE SIZE
8.704-644.0	112350	Nut Grade™	242	10 ml
8.704-645.0	112352	Nut Grade™	242	50 ml
8.704-646.0	112354	Nut Grade™	242	250 ml
8.704-648.0	112360	Stud Grade™	271	10 ml
8.704-649.0	112362	Stud Grade™	271	50 ml
8.704-650.0	112367	Penetrating Adhesive (Sealant)	290	10 ml

Nut Grade™ and Stud Grade™ are trademarks of the Oakland Corp. Loctite® is a registered trademark for the Loctite® Corp.

**GLOVES - INDUSTRIAL DUTY**

Industrial-grade gloves for most industry-needs – chemical, heat, abrasion, laceration protection.



- 8.704-668.0  
Gray – split cowhide work gloves, 2-1/2" gauntlet unlined – great general purpose work glove
- 8.704-669.0  
Black, 14" PVC glove lined with cotton for the most demanding chemical handling. Resists alkalines, acids - even works well as a sandblasting glove

PART NO.	OLD NO.	DESCRIPTION
8.704-668.0	116105	Gray Roughout
8.704-669.0	116114	Black PVC

**RAIN SUIT, 2-PIECE**



- Heavy-duty, 2-ply laminated vinyl (25 mil)
- Jacket and pants
- Bright safety yellow
- Vented for air flow

PART NO.	OLD NO.	DESCRIPTION
8.704-666.0	116100	Large
8.704-667.0	116101	Extra Large

**SHIPPING TAPE AND DISPENSER**

Big 2" x 110 yard rolls of clear Biaxially-oriented polypropylene for secure packages.



- Heavy-duty tape dispenser with serrated blade

PART NO.	OLD NO.	DESCRIPTION
8.704-707.0	118916	Dispenser Boxed
8.901-249.0	118918	110 Yard Roll

**AMAZING POCKET REFERENCE - THIRD EDITION**

A ton of information in a 5oz book!

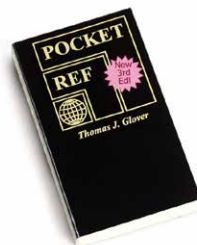

- Air and Gases, Chemistry, Math
- Plumbing and Pipe, Electrical, Automotive
- Physical Constants
- 3350 Conversion Factors
- More than 20 other subject areas

PART NO.	OLD NO.	DESCRIPTION
8.712-505.0	449015	Pocket Reference

**PROFIT FROM POWER WASHING**

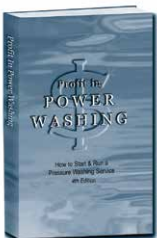

Geared specifically to determining the profitability, feasibility and marketability of owning a pressure washing business. It covers the methodology so crucial in both starting and operating a pressure washing service:

- Marketable Services and Target Markets
- Equipment Selection and Use
- Personal Safety and Important Legal Issues
- Customer Relations and Estimating and Advertising
- Chemical Selection and Use
- Much More...

PART NO.	DESCRIPTION
8.750-507.0	Profit From Power Washing



## YAMADA PUMPS



Air-powered double diaphragm pump, "Reliable Performance Since 1905". The answer to difficult product transfer problems. Air-drive allows freedom from electrical hazards or explosion-proof motor requirements. Choose from various wetted-parts materials to customize the pump to the chemical being pumped. Yamada's smaller pumps are often used for pumping car wash chemical for 'low-pressure' functions. The 1/2" pump is also ideal for rapidly pumping oil, soap, etc., from 55 gallon barrels. Larger pumps are used for high-volume product transfer. Since all pumps are designed without rotating parts, they can also handle abrasive liquids such as ceramic slip, sand slurry or enamel frit without damage. Have a unique challenge? Call us for help!



8.702-180.0



8.702-183.0

- PSI: 100
- Temperature: 180°F
- Environmentally-Friendly Non-Lube Air Valve
- Automatic Start/Stop
- Non-Stalling Air Valve - positive switching every stroke and won't ice up
- Outside Accessible Air Valve - easy inspection and maintenance
- Bolted Flange Connections - leak-free and easy maintenance
- Built-in Abrasion and Chemical-Resistance
- Virgin diaphragm material last twice as long as other pumps
- 1/4" model deliver 3.4 GPM with 20-100 PSI drive air
- 1/2" models deliver 15 GPM with 20-100 PSI drive air
- 3/4" models deliver 19.5 to 27.3 GPM with 20-100 PSI drive air
- 1" models deliver 35.7 to 48.3 GPM with 20-100 PSI drive air
- Infinitely variable flow control regulated by opening or closing discharge side valve and/or fluctuating air supply

PART NO.	OLD NO.	INTAKE AND DISCHARGE	AIR INLET W/BALL VALVE	AIR EXHAUST W/B-I MUFFLED	PUMP BODY	DIAPHRAGM MATERIAL	MAX FLOW @ 100 PSI	MAX SOLID
8.702-180.0	100381	1/4" FPT	1/4" FPT	3/8" FPT	Poly	Teflon®	3.4 GPM	N/A
8.702-201.0	100411	3/8" FPT	1/4" FPT	3/8" FPT	Poly	Santoprene®	6 GPM	1/32"
8.702-182.0	100383	1/2" FPT	1/4" FPT	3/8" FPT	Poly	Hytrel®	15 GPM	1/32"
8.702-183.0	100384	1/2" FPT	1/4" FPT	3/8" FPT	Poly	Santoprene®	15 GPM	1/32"
8.702-184.0	100385	1/2" FPT	1/4" FPT	3/8" FPT	Poly	Teflon®	15 GPM	1/32"
8.702-190.0	100394	3/4" FPT	1/4" FPT	3/4" FPT	Poly	Teflon®	27.3 GPM	1/16"
8.702-192.0	100396	1" FPT	3/8" FPT*	3/4" FPT	Poly	Neoprene	48.3 GPM	3/16"
8.702-193.0	100397	1" FPT	3/8" FPT*	3/4" FPT	Poly	Hytrel®	48.3 GPM	3/16"
8.702-194.0	100398	1" FPT	3/8" FPT*	3/4" FPT	Poly	Teflon®	48.3 GPM	3/16"
8.702-202.0	100415	1-1/2" FPT	1/2" FPT*	3/4" FPT	Alum	Buna-N	116 GPM	9/32"

\*With air-cock instead of ball valve

## DIAPHRAGM KITS FOR YAMADA PUMPS



To minimize downtime, Yamada pumps are designed for quick, trouble-free maintenance. Pump diaphragms, balls and seats can be replaced in 20 minutes or less and with little chance of leaks commonly associated with other diaphragm pumps.



- Kits include everything required for routine maintenance

PART NO.	OLD NO.	KIT	PUMP SIZE	YAMADA PUMP NO.
8.703-277.0	105004	Teflon®	1/4"	100381
8.703-278.0	105006	Hytrel®	1/2"	100383
8.703-279.0	105008	Santoprene	1/2"	100384
8.703-281.0	105010	Teflon®	1/2"	100385
8.703-282.0	105012	Neoprene	3/4"	100391
8.703-283.0	105014	Buna	3/4"	100392
8.932-947.0	105018	Teflon®	3/4"	100394
8.703-284.0	105022	Neoprene	1"	100396
8.703-285.0	105024	Hytrel®	1"	100397
8.703-286.0	105026	Teflon®	1"	100398
8.703-320.0	105150	Buna	1-1/2"	100415

Note: Individual Components (O-rings or Diaphragms Only, For Example) Also Available. Call For Pricing and Delivery.

## AIR-OPERATED PUMP

**FLOJET**

Twin diaphragm, self-priming.



- Dry Air (or CO2) PSI: 20-120
- GPM: 7.0
- Max Liquid Temperature: 120°F
- Santoprene Elastomers
- Self-Priming up to 15 Feet
- Air (Gas) in and out, 1/4" Barb
- Choice of 3/8" or 1/2" Barb Fluid in/out
- Automatic, On-Demand Start and Stop
- Flow Control via Air (Gas) Pressure
- Common use: chemical transfer and dispensing parts, washers and car wash systems

PART NO.	OLD NO.	DESCRIPTION
8.702-321.0	100874	3/8" Pump, Santoprene
8.702-322.0	100874A	3/8" Pump, Viton
8.702-323.0	100875	1/2" Pump, Santoprene
8.702-324.0	100875A	1/2" Pump, Viton

## AIR-DRIVEN PUMP

**FLOJET**

Twin diaphragm, self-priming.



- Dry Air (or CO2) PSI: 20-80
- GPM: 1.9
- Max Liquid Temperature: 120°F
- Santoprene or Viton Elastomers: use Santoprene for soaps, use Viton for Butyls
- Chemical in and out, 3/8" Barb
- Air (Gas) in and out, 1/4" Barb
- Automatic, on-demand start and stop
- Control flow and pressure with air pressure

PART NO.	OLD NO.	DESCRIPTION
8.702-320.0	100873	Pump, Santoprene
8.702-319.0	100872	Pump, Viton
8.700-387.0	075862	Diaphragm Kit, Santoprene
8.700-388.0	075863	Valve Kit, Santoprene
8.700-418.0	075907	Diaphragm Kit, Viton
8.700-419.0	075908	Valve Kit, Viton

## AIR-FILTER / REGULATORS



8.712-585.0



8.712-586.0

- PSI: 125
- 1/4" Ports
- Pressure-Relieving
- Removes air line impurities to 5 microns
- Maintains and gauges pressure to, and therefore discharges pressure from, air-driven diaphragm pumps

PART NO.	OLD NO.	DESCRIPTION
8.712-585.0	462280	Regulator Only
8.712-586.0	462285	Filter / Regulator
8.712-587.0	462290	Gauge, 0-1 60, 1/8"

## FOAM BRUSH AND ACCESSORIES



### Foam Brush

3" x 10" super soft flagged bristle fountain brush. Choose from black, red or blue.

### Foam Brush Lance

40" long with 30" insulated grip, 3/8" FPT inlet, 1/2" MPT outlet (matches brush inlet). Colors: red, blue or black.



### Brush Hoses

Clear, spiral wire braid, 1/2" ID with 3/8" MPT, zinc-plated steel fittings both ends.

PART NO.	OLD NO.	DESCRIPTION
8.710-115.0	344006	Foam Brush Head, Black
8.710-117.0	344006RED	Foam Brush Head, Red
8.710-116.0	344006BLU	Foam Brush Head, Blue
8.710-119.0	344011	Foam Hose, 15'
8.710-121.0	344014	Lance 40", Red
8.710-122.0	344014BLK	Lance 40", Black
8.710-123.0	344014BLU	Lance 40", Blue

## CAR WASH BOOMS, "REFLEX"

The performance leader!



- PSI: 3000
- 5' 6" Car Wash Model
- 8' Truck Wash Model

- Stainless-Steel Boom Arm
- 3/8" FPT Inlet / Outlet Hose Included

PART NO.	OLD NO.	DESCRIPTION
Booms		
8.903-620.0	306660X	180° Wall Mount 5' 6" Boom
8.903-621.0	306662X	360° Ceiling Mount 5' 6" Boom
8.903-624.0	306665X	180° Wall Mount 10' Boom
8.903-625.0	306666X	360° Ceiling Mount 10' Boom
8.903-626.0	306667X	180° Wall Mount 8' Boom
8.903-627.0	306668X	360° Ceiling Mount 8' Boom
Parts / Accessories		
8.903-622.0	306663X	5.5' Rod / Hose, Assy Only
8.903-623.0	306664X	8' Rod / Hose, Assy Only
8.903-628.0	306669X	10' Rod / Hose, Assy Only
8.903-630.0	306670X	Ceiling Mount, Base Only
8.903-632.0	306672X	Wall Mount, Base Only
8.700-265.0	075064X	Set Screw for Angle Block
8.905-605.0	568612	90° End Coupler C/W Boom
8.905-604.0	568610	8' Coupler Stainless-steel C/W Boom
8.712-450.0	421020	Swivel - Brass 3/8"
8.700-263.0	075060	Swivel Repair Kit (Pre-1998)
8.700-287.0	075130	Swivel Repair Kit (1998-Present)

### STAINLESS-STEEL BAY ACCESSORIES

Foam brush broom holder, wand holders, mat clamps.

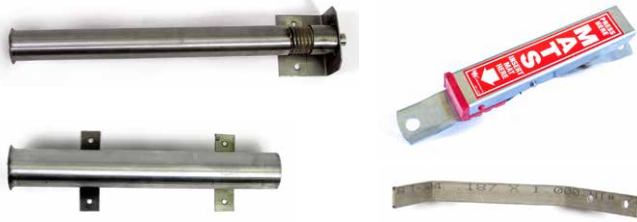

PART NO.	OLD NO.	DESCRIPTION
8.708-880.0	260600	Standard Foam Brush Holder
8.708-881.0	260605	Rigid Wall Mount Wand Holder
8.708-882.0	260606	Flex Bottom Mount Wand Holder
8.708-883.0	260610	Mat Clamp

### LOCKS FOR METER BOXES



PART NO.	OLD NO.	DESCRIPTION
8.708-731.0	260064	Disk Lock (Master Brand)
8.708-730.0	260062	Tubular Cam Lock

### ROTARY SWITCH, 8-POSITION

Metal car wash switch.



- Double Stack 8-Position
- Metal
- Much more durable than cheaper plastic switches
- Direct replacement for Electroschwitch 31302A-S and NU32LA
- Make before break functions

PART NO.	OLD NO.	DESCRIPTION
8.708-729.0	260061	8-Position Rotary Switch

### TRANSFORMERS



PART NO.	OLD NO.	DESCRIPTION
8.708-780.0	260311	115-24V AC: 600 MIL/AMP
8.708-781.0	260312	115/208/230-24V AC: 100V A Fused
8.708-783.0	260315	120/208/240-24V AC: 50V A
8.708-784.0	260316	120/208/240-24V A Not Fused

### FUSES



PART NO.	OLD NO.	DESCRIPTION
8.708-786.0	260324	Transformer Fuse 5 AMP, For P/N 260312

### MEDIUM-PRESSURE SWIVELS



- PSI: 1000
- 7/16" Flow-Thru Opening
- All-Brass Body
- Bronze-Thrust Bearing
- Buna Seals (Non-Repairable)
- 1/2" FPT x 1/2" MPT

PART NO.	OLD NO.	DESCRIPTION
8.705-057.0	140094	Swivel

### LOW-PRESSURE SWIVELS

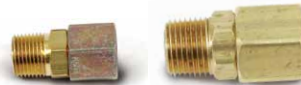

- Swivel Action PSI: 300
- Brass MPT
- Zinc-Chromate Steel FPT

PART NO.	OLD NO.	DESCRIPTION
8.705-054.0	140085	1/4" FPT x 1/4" MPT
8.705-056.0	140087	3/8" FPT x 3/8" MPT
8.705-055.0	140086	1/2" FPT x 1/2" MPT

### FLEX LANCES



- PSI: 2500
- Temperature: 200°F
- Flexes 180° and returns
- Prevents bent lances and broken hoses
- Industrial-grade polyurethane flex section
- Perfect for self-serve car wash bays
- 1/4" galvanized pipe end sections

PART NO.	OLD NO.	LENGTH / COLOR	DESCRIPTION
8.710-600.0	368119BLK	18" Black	1/4" MPT x 1/8" FPT
8.710-601.0	368119BLU	18" Blue	1/4" MPT x 1/8" FPT
8.710-603.0	368121	21" Red	1/4" MPT x 1/8" FPT
8.710-604.0	368124	24" Red	1/4" MPT x 1/8" FPT
8.710-598.0	368118	18" Red	1/4" MPT x 1/4" MPT

**VACUUM ACCESSORIES**

May slip directly on to hose. Use with swivel cuffs for better results.



**Vacuum Claw Nozzle**

PART NO.	OLD NO.	COLOR
1- 1/2"		
8.708-893.0	260917	Orange
8.708-892.0	260916	Yellow
8.708-891.0	260915	Black
8.708-890.0	260914	Gray
2"		
8.708-895.0	260919	Orange
8.708-894.0	260918	Yellow
8.708-897.0	260921	Black
8.708-899.0	260923	Gray

**Couplings**

PART NO.	OLD NO.	DESCRIPTION
8.708-896.0	260920	1-1/2"
8.708-898.0	260922	2"

**Adapter**



PART NO.	OLD NO.	DESCRIPTION
8.708-900.0	260924	2" Hose x 1-1/2" Wand
8.708-904.0	260942	2" Hose x 2" Wand

**Vacuum Nozzles**



PART NO.	OLD NO.	DESCRIPTION	DEGREE
8.708-901.0	260932	1-1/2" x 1-1/2" x 5-1/4"	45°
8.708-902.0	260934	2" x 2" x 5-1/2"	45°

**Cuffs, Hose to Tank**



PART NO.	OLD NO.	DESCRIPTION
8.708-903.0	260940	1-1/2" x 1-1/2"
8.708-904.0	260942	2" x 2"
8.708-905.0	260944	1-1/2" x 1-1/2" Swivel
8.708-906.0	260946	2" x 2" Swivel

**WASH GUN - RB65**



Low-pressure spray gun with straight jet and adjustable cone from the trigger with adjustable screws to alter cone angle wideness from 0° to 60°.



- PSI: 350
- GPM: 16.0
- Temperature: 195°F
- Completely Sealed
- Ergonomic
- Adjustable Jet Cone
- Trigger Protection
- Brass Body
- Inlet Connection Swivel

PART NO.	OLD NO.	DESCRIPTION
8.710-449.0	353265	PA RB65 W/ Awivel
8.710-448.0	353264	PA RB65 No Swivel

**CAR WASH VACUUM HOSE CW150 AND CW200**

**ULTIMATE CRUSH-PROOF**

The most flexible, easy-to-handle vacuum hose ever!



- Recovers immediately from crush
- Tough and durable
- Resists ultraviolet rays and abrasion
- Smooth interior bore for max air flow
- CW150 = 1-1/2"; CW200 = 2"

PART NO.	OLD NO.	SIZE
8.708-907.0	260950	1.5" x 15'
8.708-909.0	260954	1.5' x 25'
8.708-910.0	260956	1.5" x 50'
8.708-917.0	260962	2" x 15'
8.708-919.0	260966	2" x 25'
8.708-920.0	260968	2" x 50'

**AP VACUUM MOTORS**



**8.625-841.0**



**8.620-204.0**



**8.625-842.0**

PART NO.	DESCRIPTION
Two Fan Stages, Bypass Motors	
8.625-841.0	5.7" Diameter, 120V Double Ball Bearing, Peripheral Discharge
8.620-204.0	Vault System Vac Motor: 120V Double Ball Bearings, Tangent Discharge
Three Fan Stages, Bypass Motors	
8.625-842.0	5.7" Diameter, 120V Double Ball Bearings, Tangent Discharge

**AMETEK-LAMB VACUUM MOTORS**



8.685-502.0



8.685-442.0



8.685-458.0

PART NO.	DESCRIPTION
Two Fan Stages, Bypass Motors	
8.685-502.0	5.7" Diameter, 120V Double Ball Bearing, Peripheral Discharge
8.685-442.0	Vault System Vac Motor: 120V Double Ball Bearings, Tangent Discharge
Three Fan Stages, Bypass Motors	
8.685-458.0	5.7" Diameter, 120V Double Ball Bearings, Tangent Discharge

**CONNECTOR HOSE / CAR WASH BAY HOSE, 12'-25'**

All car wash bay hoses come with solid male pipe on both ends.



PART NO.	LENGTH	PSI
3/8" Black - 1 Wire		
8.918-333.0	12'	4000
8.918-334.0	13'	4000
8.918-336.0	14'	4000
8.918-338.0	15'	4000
8.918-340.0	16'	4000
8.918-342.0	17'	4000
8.918-344.0	18'	4000
8.918-348.0	20'	4000

PART NO.	LENGTH	PSI
1/4" Black - 1 Wire		
8.918-312.0	15'	3000
8.918-322.0	20'	3000
8.918-329.0	24'	3000
8.918-331.0	25'	3000

PART NO.	LENGTH	PSI
3/8" Blue - 1 Wire		
8.918-360.0	12'	3000
8.918-362.0	13'	3000
8.918-364.0	14'	3000
8.918-366.0	15'	3000
8.919-124.0	16'	3000
8.918-369.0	17'	3000
8.918-371.0	18'	3000
8.918-373.0	19'	3000
8.918-375.0	20'	3000
8.918-377.0	21'	3000
8.918-379.0	22'	3000
8.918-381.0	23'	3000
8.918-383.0	24'	3000
8.918-385.0	25'	3000

PART NO.	LENGTH	PSI
1/4" Blue - 1 Wire		
8.918-387.0	12'	3000
8.918-389.0	13'	3000
8.918-391.0	14'	3000
8.918-393.0	15'	3000
8.918-395.0	16'	3000
8.918-397.0	17'	3000
8.918-399.0	18'	3000
8.918-401.0	19'	3000
8.918-403.0	20'	3000
8.918-405.0	21'	3000
8.918-407.0	22'	3000
8.918-409.0	23'	3000
8.918-411.0	24'	3000
8.918-413.0	25'	3000



**SOLENOID VALVES**



- Air
- Light Oil

- Professional Car Washes
- Chemicals

- Low Pressure Steam
- Other Industrial Applications



**Water Solenoid Valves 2-way, normally closed.**

The S211 Series Standard Water Valves have reliable piloted diaphragm construction with proven performance over decades of use. Featuring stainless-steel seats, the S211 Series typically requires 4 or 5 PSI pressure differential to open. The S201 Series Zero Differential Valves are constructed with the same materials, but are capable of operating with the same amount of pressure on both sides of the valve. Both valve types are often utilized in the car wash industry.



**Chemical Solenoid Valves, 2-way, normally closed.**

For decades, car wash industry professionals have chosen the rugged S301 and S311 Series Valves because of their compact size and long life. Available in 1/8", 1/4" and 3/8" NPT designs, these valves are used in air, water and chemical applications.



**High-pressure Solenoid Valves 2-way, normally closed.**

The S401 High-Pressure Valves are compact, dependable and specifically designed by ITT to meet car wash applications up to 1400 PSI. Best Buy.

**Normally open Solenoid Valves for car wash anti-freeze applications.**

These valves provide long life and reliable performance in the "make or break" anti-freeze systems of car washes. The S202 and S212 Series Diaphragm Valves feature non-wicking, fabric-reinforced diaphragms, which eliminates premature diaphragm failures, as well as stainless-steel upper seats, which prevents seat deterioration often associated with brass-seated valves. The S202 Series Diaphragm Valve incorporates the zero-operating pressure design discussed above; the S212 Series is a piloted diaphragm, and the S402 Series is piloted piston valve.

**SOLENOID VALVES**



<b>Body</b>	<b>Seals</b>	<b>Mode</b>	<b>Type</b>			
BR = Brass		B = N/O = Normally Open	DA = Direct Acting	PP = Piloted Piston		
SS = Stainless-Steel		V = N/C = Normally Closed	PD = Piloted Diaphragm			

PART NO.	OLD NO.	GC PART NO.	PORT F-NPT / BODY	ORIFICE	OPER PSI	SEALS	MODE	TYPE / AC VOLTS	DEMA EQUIV
8.708-806.0	260451	S201-CG4	3/8" / BR	.312"	150	B	N/C	PD / 110	A413P-110
8.708-807.0	260452	S201-DG4	1/2" / BR	.438"	150	B	N/C	PD / 24	A414P-24
8.708-808.0	260453	S201-DG4	1/2" / BR	.438"	150	B	N/C	PD / 110	A414P-110
8.708-821.0	260465	S211-CG4	3/8" / BR	.625"	150	B	N/C	PD / 110	473P-110
8.708-822.0	260466	S211-DG4	1/2" / BR	.625"	150	B	N/C	PD / 24	474P-24
8.708-823.0	260467	S211-DG4	1/2" / BR	.625"	150	B	N/C	PD / 110	474P-110
8.708-824.0	260468	S211-EG5	3/4" / BR	.750"	150	B	N/C	PD / 24	476P-24
8.708-825.0	260469	S211-EG5	3/4" / BR	.750"	150	B	N/C	PD / 110	476P-110
8.708-826.0	260470	S211-FG9	1" / BR	1.00"	150	B	N/C	PD / 24	-
8.708-827.0	260471	S211-FG9	1" / BR	1.00"	150	B	N/C	PD / 110	-
8.708-829.0	260480	S301-BD7	1/4" / BR	.109"	150	B	N/C	DA / 24	401P-24
8.708-830.0	260481	S301-BD7	1/4" / BR	.109"	150	B	N/C	DA / 110	401P-110
8.708-816.0	260460	S202-DG4	1/2" / BR	.438"	150	B	N/O	PD / 24	0A414P-24
8.708-831.0	260482	S301-BD7	1/4" / SS	.125"	150	V	N/C	DA / 24	424-2-24
8.708-832.0	260483	S301-BD7	1/4" / SS	.125"	150	V	N/C	DA / 110	424-2-110
8.708-833.0	260484	S401-Z	3/8" / SS	.350"	1200	V	N/C	PP / 24	453P-24
8.708-834.0	260485	S401-Z	3/8" / SS	.350"	1200	V	N/C	PP / 110	453P-110
8.708-835.0	260486	S401-Z	1/2" / SS	.500"	1200	V	N/C	PP / 24	454P-24
8.708-836.0	260487	S401-Z	1/2" / SS	.500"	1200	V	N/C	PP / 110	454P-110

**REPLACEMENT / REPAIR KITS FOR SOLENOIDS VALVES (CONTINUED FROM PAGE 143)**

PART NO.	OLD NO.	DESCRIPTION
8.708-837.0	260488	24V AC Coil
8.700-217.0	074807	Repair Kit - S301, 1/4" Valves (Viton)
8.700-220.0	074810	Repair Kit - S211, 3/4" Valves (Buna)

**KIP SOLENOIDS**



- Reliable over years of use
- Millions of cycles life not unusual
- All with FPT Ports
- N/O = Normally Opened
- N/C = Normally Closed
- N/A = Not Adjustable
- C/A = Chemical Adjustment

PART NO.	OLD NO.	MODE	FPT	VOLTAGE	ORIFICE ID
Stainless-steel					
8.708-846.0**	260511	N/C	1/4"	24V AC N/A	.062
8.708-849.0	260520	N/C	1/8"	24V AC N/A	.062
8.708-851.0	260525	N/C	1/4"	24V AC C/A	
8.708-852.0*	260526	N/C	1/4"	24V AC C/A	
8.708-855.0	260534	N/C	1/4"	120V AC N/A	.093
8.708-856.0	260535	N/C	1/4"	24V AC N/A	.093
8.708-857.0*	260536	N/C	1/4"	120V AC N/A	.093
8.708-858.0*	260537	N/C	1/4"	24V AC N/A	.093
Brass Solenoid Valves - Kip					
8.708-863.0*	260546	N/C	1/8"	240V AC N/A	.062
8.708-864.0*	260547	N/C	1/8"	120V AC N/A	.062
Parts					
8.708-859.0	260538	Coil Only		120V, Wire Leads	
8.708-860.0	260539	Coil Only		24V, Wire Leads	

\*Conduit Body Style W/ Wire Leads    \*\* Wire Leads

**SOLENOIDS WITH BUILT-IN STRAINER**

For pressure lines and pressure systems only.



**Brass Valves - Diaphragm Style**

- Normally close valve operation
- Proven design features for reliable performance on all applications
- Operates in any position, but do NOT mount valve with coil under valve
- Rated to 200°F fluid and 120°F ambient

PART NO.	OLD NO.	DEMA NO.	FPT	ORIFICE	PSI	VOLTAGE
8.711-249.0	396115	442P	1/4"	.25	125	24V AC
8.711-250.0	396116	442P	1/4"	.25	125	110V AC
8.711-252.0	396119	443P	3/8"	.25	125	24V AC

**Celcon Plastic Valves - Super for strong chemicals**

- PSI: 125
- Temperature: 180°F
- 1/4" FPT, 1/4" Orifice
- Diaphragm style with Y-screen (S.S.)
- Molded coil CSA-approved
- Compact design - 1/4" spade connects
- Normally closed operation

PART NO.	OLD NO.	DEMA NO.	FPT	ORIFICE	PSI	VOLTAGE
8.708-869.0	260560	P442	1/4"	.25	125	24V AC
8.708-870.0	260561	P442	1/4"	.25	125	110V AC
8.708-871.0	260562	P442	1/4"	.25	125	12V AC
8.708-872.0	260566	P443	3/8"	.25	125	24V AC

**AQUA MASTER™ MODEL 440**



Liquid level proportioning controls - automatically maintain drum level and chemical concentration. The Aqua Master automatically maintains a desired level of proportioned mixture in a drum, tank or other type reservoir.

Magnetically activated "snap acting" float valves provide full water flow to activate teh chemical proportioners. There are two basic sizes to give a choice of water flows as shown in the table below. Chemical feed rate is adjusted by metering screw or threaded metering tips. The compact 440 float valve is made of Celcon® plastic and is easily accessible for field maintenance.

Liquid-level proportioning controls are available in two flow capacities, 4.0 and 22.0 GPM at 50 PSI. Either size can be used with or without a proportioner. The proportioner allows chemical to be inducted while the valve is open.

All models, except as noted, are equipped with siphon breakers to prevent backflow into the fresh water line. The proportioner discharge is provided with means for attaching a hose or piece for under water feeding to minimize sudsing.

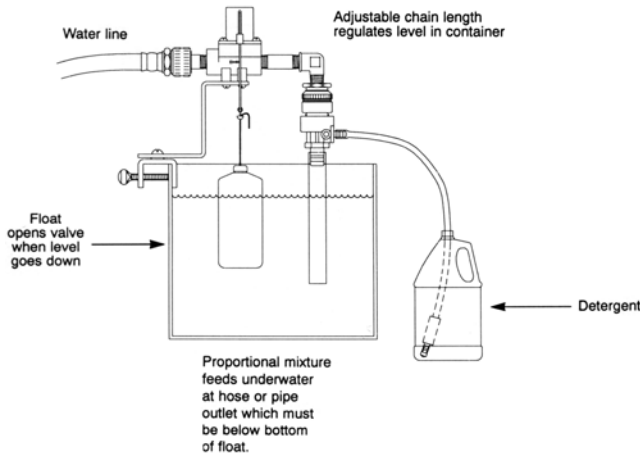

MODEL	DESCRIPTION	CAPACITY
440-23BT	Proportioning Valve, 4 GPM Flow at 50 PSI, Medium Capacity	12*
440-23T	Proportioning Valve, 4 GPM Flow at 50 PSI, High Capacity	35*
440-24	Proportioning Valve, 4 GPM Flow at 50 PSI, Highest Capacity	70*
437-21	Proportioning Valve, 22 GPM Flow at 50 PSI, Medium Capacity	10*

\*Oz / Gal of 1 CPS Fluid (ie, Viscosity of Water)

PART NO.	OLD NO.	DESCRIPTION
8.710-525.0	360382	440-23BT
8.710-524.0	360381	440-23T
8.710-526.0	360383	440-24
8.710-534.0	360399	Optional Tips

**ERIE MOTORTROL® VALVE**

The most flexible, easy-to-handle vacuum hose ever!



- Three-way valve to switch hot and cold inlets to single outlet
- 1/2" MPT (all three)
- 24V AC

PART NO.	OLD NO.	DESCRIPTION
8.708-879.0	260580	Motortrol Valve

**PROPORTIONERS**

Designed to blend liquid chemical concentrates with water (flowing at normal city water pressure) to create an accurate mix of diluted chemicals. Complete with metering orifice set and/or metering adjustment valve.

- 1 CPS = Viscosity of Water
- 75 CPS = Viscosity of SAE 10 Oil
- 220 CPS = Viscosity of SAE 30 Oil



PART NO.	DESCRIPTION	CAPACITY	
Max Blend Rate = Oz Chem Per Gal Water			
Model No.	1 CPS	75 CPS	220 CPS
162	24	14	6
163H*	64	30	14

\*High-concentration chemical blender

PART NO.	OLD NO.	DESCRIPTION
8.710-530.0	360393	#162 Drum Mount W/ Proportioner
8.710-529.0	360392	#163H High Concentrate Proportioner Low Side
8.700-226.0	074903	Polypropylene Foot Valve
8.710-534.0	360399	Optional Tips

## SEALS AND GASKETS

PART NO.	OLD NO.	DESCRIPTION	UNIT
8.712-860.0	500.110	Seal - Edge Guard, Vinyl (Pebble Finish)	FT
8.713-319.0	500.770	Seal - Bulb Type Side Profile, NBR Rubber, 7230	FT
8.714-344.0	502.426	Seal - Door Bottom 7530 (ECH Rubber 60 Duro (A))	EA
8.714-345.0	502.427	Seal - Door Bottom 7650, 7660 (ECH Rubber 60 Duro (A))	EA
8.714-341.0	502.423	Seal - Door Cabinet Side 7530 (ECH Rubber 60 Duro (A))	EA
8.714-346.0	502.428	Seal - Door Cabinet Side 7650 (ECH Rubber 60 Duro (A))	EA
8.714-350.0	502.432	Seal - Door Cabinet Side 7660 (ECH Rubber 60 Duro (A))	EA
8.714-342.0	502.424	Seal - Door Latch Side 7530 (ECH Rubber 60 Duro (A))	EA
8.714-347.0	502.429	Seal - Door Latch Side 7650 (ECH Rubber 60 Duro (A))	EA
8.714-351.0	502.433	Seal - Door Latch Side 7660 (ECH Rubber 60 Duro (A))	EA
8.714-343.0	502.425	Seal - Door Top 7530 (ECH Rubber 60 Duro (A))	EA

## FILTERS AND BASKETS



8.705-952.0

PART NO.	OLD NO.	DESCRIPTION	UNIT
8.705-952.0	200.161	Bag - Filter 150 Micron, Nylon, 18" x 14", 1816, 7220	EA
8.714-474.0	502.650	Bag - Filter 100 Micron, Krystle Klear, 8" x 30"	EA
8.731-254.0	200.162	Basket - Small Parts, 8" x 8" x 4"	EA

## HEATING ELEMENTS AND THERMOSTATS

8.713-030.0



8.713-593.0



8.712-813.0



PART NO.	OLD NO.	DESCRIPTION	UNIT
8.716-653.0	502.379	Heating Element - 1250W, 120V	EA
8.712-813.0	500.045	Heating Element - 4.5KW, 230V, 1", 1PH, 1" NPT	EA
8.712-954.0	500.238	Heating Element - 9KW, 230V, 3PH, 2" NPT	EA
8.713-030.0	500.338	Thermostat - Bulb and Capillary, 195° F (For 3PH Machines)	EA
8.713-723.0	501.348	Heating Element - 2KW, 120V	EA
8.713-593.0	501.148	Thermostat - Snap DBC 180° F	EA

## HANDLES



8.712-818.0

■ Non-Conductive

■ Non-Corrosive

PART NO.	OLD NO.	DESCRIPTION	UNIT
8.712-818.0	500.054	Handle - Lid / Door, Glass Reinforced, Nylon - Black, 7" O.C. Hole Pattern	EA
9.804-203.0	500.521	Handle - Door / Strainer (Small)	EA

## LID SUPPORTS



PART NO.	OLD NO.	DESCRIPTION	UNIT
8.712-817.0	500.053	Gas Spring - Strut (40A) - 7230	EA
8.713-317.0	500.767	Gas Spring - Strut - 7689	EA
8.714-540.0	502.820	Gas Spring - Strut - 7320 / 2003	EA

## TURNTABLE DRIVE COMPONENTS

Heavy duty.



8.714-008.0



9.804-423.0



9.804-347.0



8.712-858.0



8.712-903.0



9.804-346.0

PART NO.	OLD NO.	DESCRIPTION	UNIT
8.713-730.0	501.356	Gearmotor - AC Fractional 733x and Larger	EA
8.725-371.0		Gearmotor - APW	EA
8.725-437.0		Replacement Capacitor for 8.725-371.0	EA
8.714-009.0	501.882	Torque Limiter - Large Size	EA
8.714-008.0	501.881	Torque Limiter - Standard Size	EA
9.804-423.0	501.794	Spring - Compression (864) .8700D x 2.5 L x .120	EA
8.712-903.0	500.165	Chain W/ Connector Link 7320	EA
8.713-320.0	500.771	Chain W/ Connector Link 7230	EA
8.712-858.0	500.108	Chain W/ Connector Link 7230	EA
8.713-956.0	501.775	Chain W/ Connector Link 7530	EA
8.713-957.0	501.776	Chain W/ Connector Link 7650, 7660	EA
8.714-372.0	502.466	Chain W/ Connector Link 773x, Nickle Plated	EA
8.712-988.0	500.284	Chain W/ Connector Link 786x, Nickle Plated	EA
9.804-347.0	500.060	Bearing - Ball (Lower Turntable), Doubled Sealed	EA
9.804-346.0	500.059	Bearing - Ball (Upper Turntable), Doubled Sealed	EA
8.712-920.0	500.192	Bearing - Taper Roller Turntable, 773x, 774x, 786x	EA

## TIMERS AND SWITCHES

Easy to use and durable.



8.713-328.0



9.804-119.0



9.804-510.0

PART NO.	OLD NO.	DESCRIPTION	UNIT
8.713-357.0	500.822	Timer - 30 Min Spring Wound, Oil Skimmer	EA
8.712-832.0	500.074	Timer - 60 Min Spring Wound, Wash	EA
8.712-833.0	500.075	Timer - 12 Hour Spring Wound, Heater	EA
9.804-119.0	6-02071	Switch - Magnetic Reed Sensor N.C.	EA
9.804-118.0	6-02072	Switch - Magnetic Reed Sensor N.O.	EA
9.804-120.0	6-02073	Magnet - Reed Sensor Target	EA
8.714-018.0	501.903	Switch - Rocker (Round), TT On / Off 7230	EA
8.713-328.0	500.787	Switch - Lighted Rocker, Skimmer / TT On / Off	EA
8.749-212.0	500.811	Switch - Limited, Enclosed	EA
9.804-510.0	500.421	Switch - Lid / Door, 15 AMP	EA
8.713-631.0	501.208	Timer - Plug-In 20A, 7 Day, 24 Hour	EA



## PUMPS AND PUMP SEALS

Heavy duty.

PART NO.	OLD NO.	DESCRIPTION	UNIT
8.715-395.0	500.000	Pump - 1.0 HP, 115/230V, 1PH, Cent Horz, Sealed	EA
8.715-413.0	500.303	Pump - 3.0 HP, 115/230V, 1PH, Cent Vert, Sealless	EA
8.715-414.0	500.469	Pump - 3.0 HP, 230/480V, 3PH, Cent Vert Sealless	EA
8.715-421.0	500.185	Pump - 5.0 HP, 115/230V, 1PH, Cent Vert Sealless	EA
8.715-422.0	500.470	Pump - 5.0 HP 230/480V, 3PH, Cent Vert Sealless	EA
8.735-011.0	500.305	Pump - 7.5 HP 230/480V, 3PH, Cent Vert Sealless	EA
8.714-473.0	502.649	Seal - Pump (126), 2 Pc Viton-Silicon-Carbide, Kit (Includes O-ring)	EA
8.713-359.0	500.824	Seal - Pump (126), 2 Pc Buna-Ceramic, Model 126 Pump	EA
8.713-360.0	500.825	O-ring, Buna, Model 126 Pump	EA
8.714-320.0	502.381	Throttle Bushing - 3PH - 5PH	EA

## DETAIL COMPONENTS



8.712-778.0



9.804-091.0



8.712-810.0

PART NO.	OLD NO.	DESCRIPTION	UNIT
8.712-778.0	500.004	Pump - Air Powered Diaphragm	EA
9.804-091.0	500.049	Brush - Polyplow (Flo-Thru)	EA
8.712-810.0	500.041	Regulator - 1/4" NPT	EA
8.712-835.0	500.077	Steel Cup Brush	EA

## NOZZLES

■ 1/4" MNPT

■ Hardened Steel



PART NO.	OLD NO.	DESCRIPTION	UNIT
8.714-202.0	502.187	Nozzle - 80°, #3	EA
8.712-777.0	500.003	Nozzle - 50°, #3	EA
8.712-775.0	500.001	Nozzle - 50°, #4	EA
8.712-973.0	500.265	Nozzle - 50°, #6	EA

## MEASURING CUPS

■ Cups are calibrated for exact measurements



PART NO.	DESCRIPTION
8.697-021.0	Measuring Cups, 16 oz.
8.697-024.0	Measuring Cups, 8 oz.
8.697-023.0	Measuring Cups, 4 oz.

## WATER LEVELING SYSTEM



PART NO.	OLD NO.	DESCRIPTION	UNIT
9.804-095.0	500.114	Float - Poly Cylindrical, 1-1/2" x 3-3/4" Water Level	EA
8.712-946.0	500.225	Float - Poly Cylindrical, 2-3/4" Dia x 1-3/4" H, LWS	EA

## CONTACTORS AND RELAYS



8.713-011.0

PART NO.	OLD NO.	DESCRIPTION	UNIT
8.713-011.0	500.316	Contractor - Pole (C09), 9 AMP Inductive	EA
8.714-331.0	502.406	Contractor - 3 Pole (C12), NC Aux Contacts, 12 AMP Inductive	EA
8.714-330.0	502.405	Contractor - 3 Pole (C16), NC Aux Contacts, 16 AMP Inductive	EA
8.713-044.0	500.355	Contractor - 3 Pole (C16), 16 AMP Inductive	EA
8.713-045.0	500.356	Contractor - 3 Pole (C23), 30 AMPS	EA
8.713-649.0	501.241	Relay - Power (25A DPDT) Surface Mounts, 8 Term for 110V, 7220	EA

## SKIMMER COMPONENTS



8.904-676.0

PART NO.	OLD NO.	DESCRIPTION	UNIT
8.904-676.0	500.687	Gearmotor - AC Fractional 6 RPM, 1.03 AMP, Skimmer / Drive W/Fan	EA

## FUSES

■ Full Range of Fuses

■ Protect your Equipment



PART NO.	OLD NO.	DESCRIPTION	UNIT
8.749-237.0	502.206	Fuse - 1 AMP (ABC)	EA
8.713-912.0	500.796	Fuse - 10 AMP, Elec. Panel, 1PH	EA
8.713-078.0	500.391	Fuse - 2 AMP	EA
8.713-288.0	500.712	Fuse - 20 AMP	EA
8.713-369.0	500.847	Fuse - 25 AMP	EA
8.713-574.0	501.119	Fuse - 3 AMP	EA
8.713-291.0	500.715	Fuse - 30 AMP	EA
8.713-652.0	501.244	Fuse - 40 AMP	EA
8.749-432.0	500.708	Fuse - 50 AMP	EA
8.713-066.0	500.379	Fuse - Class CC, 10 AMP	EA
8.713-067.0	500.380	Fuse - Class CC, 12 AMP	EA
8.713-063.0	500.376	Fuse - Class CC, 15 AMP	EA
8.713-064.0	500.377	Fuse - Class CC, 3-1/2 AMP	EA
8.713-775.0	501.434	Fuse - Class CC, 6 AMP	EA
8.713-529.0	501.055	Fuse - Class CC, 8 AMP	EA
8.713-686.0	501.296	Fuse - Class R, 1-1/2 AMP	EA
8.713-080.0	500.393	Fuse - Class R, 1 AMP	EA
8.713-912.0	501.650	Fuse - Class R, 10 AMP	EA
8.713-286.0	500.709	Fuse - Class R, 2 AMP	EA
8.713-293.0	500.717	Fuse - Class R, 20 AMP	EA
8.713-920.0	501.662	Fuse - Class R, 3 AMP (1)	EA
8.713-284.0	500.707	Fuse - Class R, 30 AMP	EA
8.713-878.0	501.590	Fuse - Class R, 8 AMP	EA

## MISC REPLACEMENT PARTS

PART NO.	OLD NO.	DESCRIPTION	UNIT
8.713-037.0	500.347	Wheel - Polyolefin, 4" x 2" (Top Load)	EA
8.712-939.0	500.213	Pin - Clevis, 3/4" x 3-1/2" (Top Load)	EA
8.749-200.0	500.133	Pin - Clevis, 5/8" x 2-1/4"	EA

## HYPRO ROLLER PUMPS

Ideal for farm sprayers, pest control and chemical application usage.



- Housings available in cast-iron, Ni-resist or silver series
- Maximum Fluid Temperature: 140°
- Self-Priming Operation: roller pumps should not be run dry
- Adaptable to PTOs or Gas Engines
- Standard Seals are Viton or Buna
- Standard super rollers provide the chemical resistance of nylon and long life of polypropylene
- Rotation is determined by looking at shaft end of pump
- Counter-clockwise is standard on all except 4001 and 4101 series

PART NO.	OLD NO.	MODEL NO.	HOUSING	ROTATION	SHAFT DIA	NO. OF ROLLERS	SEALS	
8.702-281.0	100817	4101C	CI	CW	5/8"	4	V	
8.702-261.0	100784	6500C	CI	CCW	5/8"	6	V	
8.702-263.0	100784R	6500C-R	CI	CW	5/8"	6	V	
8.702-282.0	100819	7560C	CI	CCW	15/16"	8	V	
8.702-283.0	100819R	7560C-R	CI	CW	15/16"	8	V	
8.700-082.0	069665	Shaft Adapter (5/8" to 3/4")						

Note: CI = Cast-Iron, N = Ni-Resist, SL = Silver Last

## PERFORMANCE TABLES



### Series 4001

- PSI Max: 150
- GPM Max: 9.0
- RPM Max: 1,800

PRESSURE IN PSI	GPM @ 1,100 RPM	HP	GPM @ 1,400 RPM	HP	GPM @ 1,800 RPM	HP
50	4.4	.24	5.9	.32	8.0	.46
100	3.8	.41	5.3	.56	7.3	.78
125	3.5	.50	5.0	.68	7.0	.95
150	3.3	.62	4.8	.78	6.7	1.10

### Series 6500

- PSI Max: 300
- GPM Max: 18.2
- RPM Max: 1,000

PRESSURE IN PSI	GPM @ 1,100 RPM	HP	GPM @ 1,400 RPM	HP	GPM @ 1,800 RPM	HP
50	8.0	.38	16.5	.71	20.1	.90
100	7.2	.68	15.4	1.26	19.1	1.51
200	5.6	1.29	14.0	2.34	17.3	2.84
300	4.3	1.91	12.7	3.47	15.7	4.17

### Series 4101

- PSI Max: 150
- GPM Max: 7.0
- RPM Max: 2,600

PRESSURE IN PSI	GPM @ 1,100 RPM	HP	GPM @ 1,400 RPM	HP	GPM @ 1,800 RPM	HP
50	4.5	.34	5.60	.40	6.6	.46
100	3.9	.56	5.0	.68	6.0	.76
125	3.7	.68	.82	.82	5.7	.92
150	3.4	.78	4.40	.96	5.4	1.08

### Series 7560

- PSI Max: 300
- GPM Max: 22.5
- RPM Max: 1,000

PRESSURE IN PSI	GPM @ 1,100 RPM	HP	GPM @ 1,400 RPM	HP	GPM @ 1,800 RPM	HP
50	11.1	.74	17.5	1.26	22.0	1.78
100	10.3	1.25	16.9	1.95	21.3	2.53
200	8.6	2.26	15.5	3.40	20.0	4.20
300	7.1	3.30	18.9	5.30	18.0	6.10

## FLOJET DIAPHRAGM PUMP



Built-in pressure switch automatically starts and stops pump instantaneously.



- Can run dry without damage
- Excellent Self-Priming Capability
- Low-Current Draw

PART NO.	OLD NO.	FLOJET MODEL NO.	MAX FLOW	MAX PSI	PORTS	DIAPHRAGM*	VALVES*
8.702-325.0	100879	2135-561	12V DC	1.48	60	3/8" FPT	B V
8.702-328.0	100884	4300-142A	12V DC	3.30	40	1/2" Barb	S E
8.702-312.0	100863	2100-032	115V	1.85	50	3/8" FPT	S S
8.702-337.0	100895	2100-022A	115V	1.85	50	3/8" FPT	V V
8.702-331.0	100888	4300-042	115V	3.70	35	1/2" Barb	S E
8.702-329.0	100884A	4300-043A	115V	4.70	35	1/2" Barb	S E

\*B = Buna V = Viton E = EPDM S = Santoprene

Note: These units are designed to withstand many harsh chemicals. However, because compounds and concentrations of materials pumped through these units are beyond the manufacturer's control, the manufacturer DOES NOT PROVIDE A WARRANTY on the wet-end of the pump.

## DIAPHRAGM PUMP UNITS



1.0 - 3.8 GPM integrated pump motor units. Powered by 12V DC or 115V AC power. Pumps are standard with Santoprene® diaphragms and Viton valves for excellent service with a wide variety of sprayable products.

NOTE: Flow is reduced as pressure is increased (i.e. 100580 pumps 1.12 GPM at 60 PSI) automatic demand control on/off.



- Chemical-Resistant Materials
- Self-Priming
- Automatic demand pressure switch or interanl bypass
- Can run dry without damage
- Low-Amp Draw

PART NO.	OLD NO.	SHURFLO MODEL NO.	POWER	MAX FLOW	MAX PSI	PORTS	DIAPHRAGM*	VALVES*
8.702-294.0	100841	8000-541-236	Demand	12V DC	1.0	60	3/8" FPT	S V
8.702-304.0	100854	8000-343-236	Demand	12V DC	1.2	60	3/8" FPT	V V
8.702-300.0	100850	8000-543-236	Demand	12V DC	1.8	60	3/8" FPT	S V
8.702-296.0	100844	8000-543-238	Demand	12V DC	1.4	100	3/8" FPT	S V
8.702-335.0	100893	8030-813-239	Demand	12V DC	1.5	150	3/8" FPT	S V
8.702-302.0	100852	8002-793-238	Demand	12V DC	1.7	100	3/8" FPT	S E
8.702-311.0	100862	8000-532-256	Demand	115V	1.0	60	3/8" FPT	S V
8.702-307.0	100857	8000-033-236	Demand	115V	1.0	60	3/8" FPT	V V
8.702-306.0	100856	8000-533-236	Demand	115V	1.4	60	3/8" FPT	S V
8.702-334.0	100892	8000-812-288	Bypass	115V	1.4	100	3/8" FPT	S V
8.702-308.0	100858	8000-813-238	Demand	115V	1.6	100	3/8" FPT	S V
8.702-338.0	100896	8000-713-238	Demand	115V	1.6	100	3/8" FPT	S E

2088 Premium Series - Self-Primes Up To 12 Ft. - Built-In Back Check

8.702-305.0	100855	2088-343-135	Demand	12V DC	3.0	50	1/2" - 14M	S V
8.702-303.0	100853	2088-313-145	Demand	12V DC	3.6	50	1/2" - 14M	S V
8.702-301.0	100851	2088-712-244	Demand	12V DC	3.8	50	1/2" - 14M	S E
8.702-310.0	100861	2088-394-154	Demand	115V	3.2	40	1/2" - 14M	S V

4111 - Double Head

8.702-339.0	100899	4111-035	Demand	12V	7.0	50	1/2" - 14M	S V
-------------	--------	----------	--------	-----	-----	----	------------	-----

166 - Air Drive

8.702-317.0	100870	166-200-56	Demand	AIR	2.0	60	3/8" Barb	E E
-------------	--------	------------	--------	-----	-----	----	-----------	-----

\*V = Viton E = EPDM S = Santoprene

Note: These units are designed to withstand many harsh chemicals. However, because compounds and concentrations of materials pumped through these units are beyond the manufacturer's control, the manufacturer DOES NOT PROVIDE A WARRANTY on the wet-end of the pump.



## AQUATEC 550 SERIES DIAPHRAGM PUMP

These pumps can either be controlled by a pressure switch ("demand" mode) or an external power control device. When required, an integrated bypass can be incorporated to help regulate pressure levels.



- Powerful flow rates up to 5.5 GPM / 21 LPM at pressures up to 80 PSI / 5.5 Bar
- Patented 5-Chamber diaphragm and piston design
- Quiet noise levels and with minimal pulsations

PART NO.	AQUATEC MODEL NO.	POWER	MAX FLOW	MAX PSI	PORTS	DIAPHRAGM*	VALVES*
8.750-812.0	25513-1E11-M638	12V DC	5.3	60	1/2" NPT	S	E

## AQUATEC 550 SERIES DIAPHRAGM PUMP

Excellent pre-prep chemical applicator. Trigger control, demand flow, wall-mount cabinet, enclosed pump unit pulls chemical from a bulk tank and delivers it through 100' lightweight hose for low-pressure stream / cone or mist application. Operator simply squeezes trigger for instant application.



- Diaphragm Pump Units
- PSI: 60
- Choice of 12V DC or 110V DC
- 100-Foot Hose
- Adjustable nozzle for cone mist to straight stream
- Durable Santoprene and Viton-Wetted Parts

PART NO.	OLD NO.	DESCRIPTION	MOTOR	PSI	GPM
Wall Mount / Cabinet Sprayer					
8.906-090.0	810020	Chem Applicator	115V AC	60	1.15
8.906-089.0	810010	Chem Applicator	12V DC	60	1.02

Note: These units are designed to withstand many harsh chemicals. However, because compounds and concentrations of materials pumped through these units are beyond the manufacturer's control, the manufacturer DOES NOT PROVIDE A WARRANTY on the wet-end of the pump.

## TRIGGER VALVES

Versatile hand-held trigger valves for chemical or water-flow control.



- PSI: 700
- GPM: 18.5
- 1/2" FPT Inlet/Outlet
- Lock-On Trigger Loop

PART NO.	OLD NO.	DESCRIPTION
Aluminum Body - SS / BR Valve		
8.708-982.0	266652	Trigger Valve - Viton
Plastic Body - SS / BR Valve		
8.708-983.0	266658	Trigger Valve - Viton
8.708-984.0	266659	Trigger Valve - Buna

Specifications, product descriptions and product availability subject to change without notice.

## SPRAYMAX TRIGGER GUN

For pest control applications.



- PSI: 1000
- Temperature: 200°
- Compare to JD-9, Mag-1, Robco and Ges
- Adjusts from fine mist to straight stream
- Drip-Free Shutoff
- Crafted for all-day comfortable use
- Larger trigger for 4-fingered grip

PART NO.	OLD NO.	DESCRIPTION
8.708-995.0	266693	With 1/2" Inlet
8.709-028.0	268047	Repair Kit

## TURBINE SERIES GUNS

Forged-brass housings, stainless-steel lances, mist cone to straight stream adjustment, on/off control, lock-on trigger, 1/2" MPT inlet Viton seals, up to 1200 PSI at 140°F.



- PSI: 1200
- 1/2" BSP Male Inlet
- Weight: 4 lbs
- Standard 15 x 1 LRT (4.5 mm)
- 62 ft - Reach, Straight Stream at 850 PSI, 31.5 ft - Reach, Full Cone at 850 PSI

PART NO.	OLD NO.	DESCRIPTION	LENGTH
8.708-990.0	266680	Long Range Turbine	27-1/2"
8.708-989.0	266676	Turbine	26-1/2"



## GUN ASSEMBLY - 910 SPOT SPRAY

High-pressure trigger gun adapted to spot spray application.



- Durable and comfortable
- 12" Plated Steel Lance
- 1/4" Hose Barb Inlet
- #2 Blue Adjustable Nozzle

PART NO.	OLD NO.	DESCRIPTION
8.904-088.0	352940	910 Spot Spray Gun Assembly

## TRIGGER-CONTROL SPRAY LANCES

Excellent for low-pressure chemical applications up to 150 PSI. Available in either plastic- or brass-lance tube. Works well with neutral, alkaline or mild acid solutions.



- Steel Trigger and Service Wrench
- Plastic Valve Body
- Brass-Needle Plunger
- Filter Screen in Nozzle Housing
- Cone Nozzle Adjusts 0-80°
- 24" Lance - Brass or Plastic
- Standard 11/16" outlet thread for standard low-pressure nozzle
- Accepts the adjustable cone nozzles or standard tip-jet nozzles (11/16 nozzle thread)

PART NO.	OLD NO.	DESCRIPTION
Trigger Lance		
8.902-777.0	266606	Brass W/O Nozzle
8.902-778.0	266607	Plastic W/O Nozzle
8.708-977.0	266603	Plastic W/ Red Nozzle
8.708-978.0	266610	Brass W/ Red Nozzle
8.700-493.0	076700	Needle Valve and Seal Kit

PART NO.	OLD NO.	DESCRIPTION	80° STRAIGHT	CONE
Adjustable Nozzle - GPM @ 40 PSI / Adjust 0-80°				
8.708-980.0	266612	#2 Red	.545	.204
8.708-981.0	266613	#3 Blue	.720	.250

## BRASS PRESSURE REGULATOR



- Durable and Strong
- 3/4" FPT Outlet
- Temperature: 120°F
- Weight: 10.3 oz
- Sprayers pumping up to 15 GPM
- Adjustable Pressure Ranges
- Stainless-Steel Spring
- Tee-Handle Adjustment Screw
- 3/4" MPT Inlet
- Knurled locknut for ease of locking in adjustment

PART NO.	OLD NO.	PSI	DESCRIPTION
8.712-557.0	462217	0-3000	3/4" FPT Outlet x 3/4" MPT Inlet
8.712-558.0	462218	300-700	3/4" FPT Outlet x 3/4" MPT Inlet

## HEAVY-DUTY SWIVELS

Live swivels help prevent twisted and tangled hose.



8.708-996.0

- PSI: 600
- Brass Body, Stainless-Steel Bolt
- Viton Seals
- 1/2" MPT inlet and 1/2" outlet

PART NO.	OLD NO.	PSI	DESCRIPTION
8.708-996.0	266700	600	Swivel 1/2" M x F
8.708-997.0	266701	600	Swivel 1/2" M x 3/4" FGH

## TRIGGER-JET SPRAY LANCES

Low-pressure chemical application lance will tolerate mild acid solutions.



- PSI: 150
- Diaphragm Shut-Off Valve
- Hand-Grip Trigger Control
- Plastic lance tube resistant to acids and agricultural chemicals
- Excellent for mild acids or alkali chemicals
- Polypropylene Body EPDM Seals STD
- 11/16" - Nozzle Connect Outlet

PART NO.	OLD NO.	DESCRIPTION
Trigger Lance		
8.709-182.0	302250V	24", 1/4" FPT Inlet, Viton
8.709-184.0	302252V	3/8" Hose Barb, Viton
Trigger Value Only		
8.709-185.0	302254V	3/8" HP Inlet, 11/16" Outlet, Viton
8.709-186.0	302255V	1/4" HB Inlet, 11/16" Outlet, Viton
8.709-187.0	302256V	1/4" FPT Inlet, 11/16" Outlet, Viton
Parts and Accessories - Trigger Jet Lance		
8.709-188.0	302258	Adapter, 11/16" x 11/16" PP
8.709-189.0	302259	24" Lance Tube Only
8.709-190.0	302260	24" Lance Tube W/ Seals and Fittings
Trigger Jet Nozzles - Polypropylene, Adjust From 0° to 60°		
8.709-192.0	302263	Yellow Core (x 3), .23 GPM / 60 PSI
8.709-193.0	302265	Green Core (x 5), .37 GPM / 60 PSI
8.709-194.0	302266	Red Core (x 6), .45 GPM / 60 PSI
8.709-195.0	302268	Gray Core (x 8), .57 GPM / 60 PSI
8.709-196.0	302272	Brown Core (x 12), .84 GPM / 60 PSI
8.709-197.0	302274	Orange Core (x 18), 1.2 GPM / 60 PSI

## LONG RANGE TIP - 15 X 1 - STAINLESS-STEEL

Best used with long-range turbine gun.



- PSI: 850
- GPM: 24.4
- 15 x 1 Long-Range Tip
- Stainless-Steel Body
- 77 ft Max Throw Range

PART NO.	OLD NO.	ORIFICE DIA (MM)
8.708-998.0	266706	3.5
8.708-999.0	266707	4.0
8.709-000.0	266708	4.5
8.709-001.0	266709	5.0
8.709-002.0	266710	5.5
8.709-003.0	266711	6.0
8.709-004.0	266712	7.0

## LOW-FLOW BRASS PRESSURE REGULATOR



- 1/2" MPT Inlet
- 1/2" Outlet
- Temperature: 120°F
- Weight: 10.3 oz
- For sprayers pumping up to 5 GPM
- Durable and strong brass construction
- Stainless-Steel Spring
- Positive Viton Seal to prevent leakage
- Knurled locknut for easy adjustment

PART NO.	OLD NO.	DESCRIPTION
8.712-553.0	462207	200-650 PSI
8.712-554.0	462208	0-300 PSI

## NYLON PRESSURE REGULATOR

Maximum corrosion resistance.



- Male Inlet / Female Outlet
- Temperature: 120°F
- Weight: 4 oz
- Up to 15.0 GPM
- Stainless-Steel Spring
- Positive Viton Seal to prevent leakage and provide best chemical resistance
- Knurled locknut for easy adjustment
- Tee-Handle Adjustment Screw
- Choice of 1/2" or 3/4" Inlet / Outlet

PART NO.	OLD NO.	INLET	OUTLET	ADJUSTABLE PRESSURE RANGE
8.712-555.0	462212	1/2"	3/4"	0-250 PSI
8.712-552.0	462202	3/4"	3/4"	0-250 PSI
8.712-556.0	462213	3/4"	3/4"	0-400 PSI

## BULKHEAD FITTINGS



- Black Polypropylene
- Double-Threaded with EPDM Gasket
- Opening same size as outside diameter

PART NO.	OLD NO.	FPT	HOLE DIA
8.705-336.0	141232	1/2"	1-5/8"
8.705-338.0	141234	3/4"	1-5/8"
8.705-144.0	140430	3/4"	1-3/4"
8.705-145.0	140432	1"	1-3/4"
8.705-339.0	141236	1"	2-1/2"
8.705-341.0	141238	1-1/4"	2-1/2"
8.705-342.0	141240	1-1/2"	2-1/2"
8.705-146.0	140434	1-1/2"	3"
8.705-147.0	140436	2"	3"
8.705-343.0	141242	2"	3-1/8"
Gasket for Above			
8.705-337.0	141233	Fits 1/2", 3/4"	
8.705-340.0	141237	Fits 1", 1-1/4", 1-1/2"	
8.705-344.0	141243	Fits 2"	

Specifications, product descriptions and product availability subject to change without notice.

## BRASS BULKHEAD / TANK FITTINGS



- Use to drain or remove liquids from tanks, drums, etc.
- Heavy-Duty Brass
- Includes nut and aluminum grip water

PART NO.	OLD NO.	OVERALL LENGTH	MOUNTING HOLE DIA
8.705-139.0	140417	1/8" x 1.5"	5/8"
8.705-140.0	140419	1/4" x .94"	3/4"
8.705-141.0	140420	1/4" x 1.5"	3/4"
9.802-149.0	140421	3/8" x 1.3"	1"
9.802-150.0	140422	1/2" x 1.5"	1-1/8"

Note: Installation requires access to inside of tank

## DIAPHRAGM CHECK VALVES - NYLON

For drip-free spraying.



- PSI: 125
- Operating Pressure PSI: 10
- GPM: 2.0
- Nylon Body, Polypropylene End Cap - EPDM - Diaphragm
- 1/4" MPT Inlet, 11/16" - 16 Male Outlet Nozzle Thread
- Spring-backed diaphragm for positive actions

PART NO.	OLD NO.	DESCRIPTION
8.709-377.0	310851	Diaphragm Check Valves

- DO NOT USE... Polypropylene for: gasoline, nitric acid, trichlorethylene, toluene, aromatic hydrocarbons or kerosene. Polypropylene "P" - black / glass reinforced
- DO NOT USE... Nylon for: hydrochloric acid, chlorine, fluorine, nitric, xylene or phosphoric or sulfuric acids. Nylon 6/6 "N" white / natural color.

## TWIN-DIAPHRAGM SPOT SPRAY PUMP

**FLOJET**



- PSI: 35 (#8 Tip)
- GPM: 1.0 (Open)
- 3/8" Hose Barb Inlet / Outlet
- Self-Priming to 2.5 Feet
- Operating Temperature: 40° - 110°F
- Liquid Temperature Max: 110°F
- 5 Amp Fuse
- Dry Weight: 1.3 lbs
- Chemical-Resistant Valves and Diaphragm
- Compact automatic on-demand operation
- Sealed pressure switch automatically stops pump when discharge valve opens and closes
- Self-priming so pump can be located above supply tank
- Can run dry for extended periods without damage
- Built-In Thermal Protection on 12V DC Motor
- Low-Amp Draw (2.5 at 25 PSI, 4.0 at 35 PSI)

PART NO.	OLD NO.	DESCRIPTION	OPEN
8.702-326.0	100880	Spot Spray Pump, Max 35 PSI, 12V DC	1.0

**PLASTIC FITTINGS**

For cater and chemical supply lines. Ideal for use with most alkaline-based detergents, most agricultural chemicals, ethanol, and most ammonium and sodium-based compounds.

■ PSI: 150

■ Temperature Max: 140°F at 90 PSI

■ Temperature Max: 90°F at 150 PSI



PART NO.	OLD NO.	DESCRIPTION	BARB X MPT
Hose Barbs - Barb x MPT			
8.705-262.0	141077P	Poly	1/4" x 1/4"
8.705-264.0	141080P	Poly	1/4" x 3/8"
8.705-263.0	141078P	Poly	3/8" x 1/4"
8.705-265.0	141081P	Poly	3/8" x 3/8"
8.705-268.0	141084P	Poly	1/2" x 3/8"
8.705-270.0	141086P	Poly	5/8" x 1/2"
8.705-277.0	141102N	Nylon	1/4" x 1/4"
8.705-280.0	141105N	Nylon	1/4" x 3/8"
8.705-278.0	141103N	Nylon	3/8" x 1/4"
8.705-281.0	141106N	Nylon	3/8" x 3/8"
8.705-284.0	141110N	Nylon	3/8" x 1/2"
8.705-282.0	141107N	Nylon	1/2" x 3/8"
8.705-285.0	141111N	Nylon	1/2" x 1/2"
8.705-288.0	141117N	Nylon	1/2" x 3/4"
8.705-283.0	141108N	Nylon	5/8" x 3/8"
8.705-286.0	141112N	Nylon	5/8" x 1/2"
8.705-289.0	141118N	Nylon	5/8" x 3/4"
8.705-287.0	141113N	Nylon	3/4" x 1/2"
8.705-290.0	141119N	Nylon	3/4" x 3/4"
8.705-291.0	141120N	Nylon	1" x 3/4"
90° Barb x MPT Elbows			
8.705-293.0	141125P	Poly	1/4" x 1/4"
8.705-296.0	141130P	Poly	1/4" x 3/8"
8.705-294.0	141126P	Poly	3/8" x 1/4"
8.705-298.0	141131P	Poly	3/8" x 3/8"
8.705-301.0	141136P	Poly	3/8" x 1/2"
8.705-295.0	141127P	Poly	1/2" x 1/4"
8.705-299.0	141132P	Poly	1/2" x 3/8"
8.705-303.0	141137P	Poly	1/2" x 1/2"
8.705-307.0	141141P	Poly	1/2" x 3/4"
8.705-304.0	141138P	Poly	5/8" x 1/2"
8.705-308.0	141142P	Poly	5/8" x 3/4"
8.705-305.0	141139P	Poly	3/4" x 1/2"
8.705-310.0	141143P	Poly	3/4" x 3/4"
8.705-397.0	141131N	Nylon	3/8" x 3/8"
8.705-300.0	141136N	Nylon	3/8" x 1/2"
8.705-302.0	141137N	Nylon	1/2" x 1/2"
8.705-306.0	141141N	Nylon	1/2" x 3/4"
8.705-309.0	141143N	Nylon	3/4" x 3/4"

PART NO.	OLD NO.	DESCRIPTION	BARB X MPT
HEX Nipple - MPT x MPT			
8.705-316.0	141184P	Poly	1/4" x 1/4"
8.705-317.0	141185P	Poly	3/8" x 3/8"
8.705-323.0	141190P	Poly	1/2" x 3/8"
8.705-319.0	141186P	Poly	1/2" x 1/2"
8.705-326.0	141193P	Poly	3/4" x 1/2"
8.705-321.0	141187P	Poly	3/4" x 3/4"
8.705-324.0	141191N	Nylon	1/2" x 1/4"
8.705-318.0	141186N	Nylon	1/2" x 1/2"
8.705-320.0	141187N	Nylon	3/4" x 3/4"
Elbows - Barb x Barb			
8.705-335.0	141216P	Poly	3/8" x 3/8"
Tees Barb x Barb x Barb			
8.705-327.0	141202N	Nylon	1/4" B x B x B
8.705-328.0	141205N	Nylon	3/8" B x B x B
"Push-On" Hose Barbs - Normally Does Not Require Clamps			
8.705-346.0	141305N	Nylon	1/4" B x 1/4" FPT

## SPRAYERS & PARTS

### STAINLESS-STEEL INDUSTRIAL SPRAYER

2-gallon industrial sprayer.  
Plastic valve and brass extensions, fan-spray tip.



- Heavy-Duty Stainless-Steel Tank
- Plastic Valve with Brass Extension
- Chemical-Resistant Seals
- Available in 2- and 3-Gallon Capacities
- Plastic Pin-to-Cone Spray Tip
- Funnel Top Design

PART NO.	DESCRIPTION
8.697-170.0	Stainless-steel Industrial Sprayer

### STAINLESS-STEEL SPRAYER

2-gallon sprayer with plastic valve and extension.  
Adjustable pin-to-cone tip.



- Heavy-Duty Stainless-Steel Tank
- Chemical-Resistant Hose
- Plastic Valve and Extension
- Buna-N Seals and Gaskets
- Pin-to-Cone Adjustable Spray Tip
- 2-Gallon Capacity
- Economically priced but durable

PART NO.	DESCRIPTION
8.697-169.0	Stainless-steel Sprayer

### SPRAYMASTER - HIGH-PRESSURE

5-quart high-pressure Spraymaster.



- 4-1 or 9-1 dilution ratio

PART NO.	DESCRIPTION
8.697-413.0	Spraymaster High-Pressure

### SPRAYER - CHEMICAL-RESISTANT

Large funnel top, poly-molded, chemical-resistant.



- Heavy-Duty Polyethylene Tank
- Wide base for extra stability
- Durable Brass Valve and Extension
- Chemical-Resistant Seals
- Reinforced Chemical-Resistant Hose
- Celcon Fan Spray Tip
- Brass Spray Gun

PART NO.	DESCRIPTION
8.697-165.0	Sprayer Chemical Resistant - 1 Gallon
8.697-168.0	Sprayer Chemical Resistant - 2 Gallon
8.697-171.0	Sprayer Chemical Resistant - 3 Gallon

### POLY-MOLDED SPRAYER

3-gallon poly-molded sprayer with maximum chemical resistance.



- Heavy-Duty Design, Economical Price
- Blue Poly-Molded Tank
- Funnel top design for ease-of-filling
- Durable Plastic Valve and Extension
- Pin-to-cone Spray tip fully repairable
- Braided, reinforced hose
- Optional Flat-Fan Spray Tips Available
- Buna Gaskets and Seals

PART NO.	DESCRIPTION
8.697-172.0	Poly-Molded Sprayer

### FOAM NOZZLE ATTACHMENT

Foaming nozzle attachment fits: stainless and hand-held sprayers.



PART NO.	DESCRIPTION
8.697-164.0	Foam Nozzle Attachment

### SPRAYMASTER - STANDARD

7-quart standard Spraymaster.



- 9-1 complete
- Includes swivel quick disconnects
- T-jet / Check Valve

PART NO.	DESCRIPTION
8.697-412.0	Spraymaster Standard

## TILE & HARD SURFACE TOOLS

### HARD-SURFACE SPINNER TOOL

Professional-grade, hard-surface spinner tool.



- All Stainless-Steel Construction
- Vacuum hose inlet fits either 1.5" or 2" hose
- Angled nozzles, splashguard, high-pressure double-bearing and ceramic-seal assembly ensures professional results

PART NO.	DESCRIPTION
8.697-376.0	Hard-Surface Spinner Tool

## VAN ACCESSORIES

### SOLUTION HOSE LIVE SWIVEL ASSEMBLY

Turns your solution reel live for direct hookup.



- High-Pressure
- 1/4" Hose

PART NO.	DESCRIPTION
8.697-344.0	Solution Hose Live Swivel Assbly

## RESTORATION EQUIPMENT & ACCESSORIES

### WATERPROOF EXSTIK PH METER



- 1-, 2- or 3-point calibration automatically recognizes buffer solutions
- Automatic temperature compensation simultaneous display of pH quad temperature
- Display indicates when the reading is stabilized
- Data Hold, Auto Power-Off and Low-Battery Indication
- Waterproof design floats in water and protects the meter in wet environment
- Interchangeable probes available for Chlorine and ORP
- Optional weighted base holds head diameter: 3.375" or 55 mm
- Body Diameter: 1.5" or 38 mm
- Length: 12" or 254 mm plastic cup and ExStik® meter

PART NO.	DESCRIPTION
8.697-330.0	Waterproof ExStik pH Meter

## SONIN DIGITAL MOISTURE METER



- Measures moisture levels from 5 to 40%, resolution 1%
- Easy-to-read, large LCD display with low-battery symbol
- Date-hold function
- Replacement probe included
- Protective carrying pouch included

PART NO.	DESCRIPTION
8.750-460.0	Sonin Digital Moisture Meter

## UV FLASHLIGHT BLAZE 128 LED

28 individual LED UV flashlight.

The Blaze-XL 128 flashlight offers an amazing 128 individual LEDs which makes it the largest LED flashlight on the market. Unlike the higher wave length 400 nm versions that come with a strong visible purple light and a hefty price tag, this one puts out less visible light making inspections more accurate and easier. All of this packed in a lightweight aluminum body weighing just 22 ounces.



- Bulb Type: 390 to 395 (nm)
- Bulb Life: 100,000 Hours
- Head Diameter: 3.375" or 55 mm
- Body Diameter: 1.5" or 38 mm
- Length: 12" or 254 mm
- Body Material: aluminum with "O" rings for water resistance
- Battery Require: 3 x D size alkaline battery (not included)
- Battery Life: Approximately 40 hours on three D-size batteries
- Switch Type: Click On / Click Off
- Weight: 1.5 LB (without batteries)

PART NO.	DESCRIPTION
8.697-331.0	UV Flashlight 128 LED Blaze

## SONIN 4-IN-1 MULTIFUNCTION DETECTOR

4-1-1 stud, moisture, metal and voltage detector.



- Detects moisture percentages 8% - 22%
- Helps find if potentially damaging excess moisture is present
- Locate and trace water leaks to prevent wet rot
- Detects wood and metal studs, beams and joists behind walls up to 3/4" deep
- One-year warranty
- Non-contact voltage detection helps you trace and locate live AC wire behind walls, ceilings, up to 2" deep
- Detects nails in wood up to 2" deep
- Low-battery warning
- Fast, accurate and easy-to-read LED display with audible indicator
- Requires one 9V battery (not included)
- Detect and locate hidden metal, steel and copper pipes and frames (both ferrous and non ferrous) behind walls up to 2" deep
- Microprocessor-based instrument with automatic calibration to ensure accuracy

PART NO.	DESCRIPTION
8.697-029.0	Sonin 4-in-1 Multifunction Detector



## EXTECH PH METER BUFFER SOLUTION

Calibrating buffer solution.



PART NO.	DESCRIPTION
8.697-395.0	Buffer Solution - pH 10
8.697-397.0	Buffer Solution - pH 7
8.697-396.0	Buffer Solution - pH 4

## SONIN MULTI-MEASURE 45

Easy-to-use tapeless distance-measuring tool. Get the entire square footage of a house in only minutes.



- Measures from 1' 10" up to 45 feet (13 meters)
- Displays measurements to the 1/4"
- Measures in Ft/In, M/Cm
- Tracking and Validate Modes
- Automatic internal temperature compensation
- Auto shut-off seven minutes after last use
- Multi-lingual detailed instruction booklet
- Multi-lingual quick-reference instruction label
- Requires one 9V battery (not included) Accuracy 99.5% +/- 1/4" (1 cm)
- Recommended for indoor-use only
- Computes areas and volumes
- Low-battery warning
- One-year warranty

PART NO.	DESCRIPTION
8.697-037.0	Sonin Multi-Measure 45

## SONIN MOISTURE TEST METER

Dual-reading scale gives relative (1-10) and moisture percentages 10-28% readings.



- Instruction Sheet Included
- One-Year Warranty
- Helps you to select drier lumber
- Contact probes are on a 3'-coiled cable for detecting moisture in hard to reach spots
- The 10-point scale corresponds to moisture levels from 10-28%
- Scale and reference chart correlate relative and moisture percentage readings
- Great for inspectors, contractors and homeowners
- Requires one 9V battery (not included)
- Test hard or soft wood, concrete, plaster, carpet and more to determine the extent of moisture problems
- Find out if potentially damaging excess moisture is present
- Locate and trace roof leaks and water seepage; assess the extent of wet rot and hidden condensation
- Use it to check surfaces before painting, wallpapering or laying floors or tile

PART NO.	DESCRIPTION
8.697-031.0	Sonin Moisture Test Meter

## OZONE GENERATOR VILLA 1000

Eliminate odors naturally.

The odor-free purifier will oxidize unwanted odors in your facility. It generates O3 or ozone, which disbursses into the space to be treated. The O3 attacks odors at their source and sanitizes the entire treatment area. It is especially effective on:



- Cigarette Smoke
- Mold and Mildew
- Smoke Damage
- Food Odors
- Pet Odors
- Carpet Odors
- Water Damage
- Cleaning Fumes
- Beverage Odors
- Decaying Matter
- New Construction
- Microorganisms

PART NO.	DESCRIPTION
8.697-128.0	Ozone Generator Villa 1000

## CARBON, VAPOR LOCK FILTER

Third-stage, vapor-lock carbon filter.



- Third-stage, 2" high-capacity, carbon, vapor-lock filter
- The third-stage filter has woven carbon media for absorption of gases and odors
- It is recommended you change the third-stage filter every six to 12 months under normal operating conditions

PART NO.	DESCRIPTION
8.697-390.0	Carbon, Vapor Lock Filter

## SECOND-STAGE PARTICULATE FILTER

2" second-stage, pleated particulate filter.



- Second-stage, pleated particulate filter
- Removes more finer particulates than the first-stage filter
- It is recommended you change the second-stage filter every six to nine month under normal operating conditions

PART NO.	DESCRIPTION
8.697-389.0	Carbon, Vapor Lock Filter

## FIBER TRAPPER PRE-FILTER

Particulate pre-filter for air filtration units used for commercial, industrial, residential and healthcare applications.

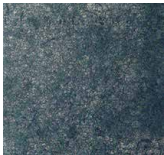

The FiberTrap pre-filter is designed to capture the coarsest particles circulating through your air duct system which helps to extend the life of the second-stage carbon-pleated filter and the HEPA filter, saving you money!

PART NO.	DESCRIPTION
8.697-386.0	Fiber Trapper Pre-Filter

## HEPA FILTER PRED 1200

Final-stage, round High-Efficiency Particulate Arresting (HEPA) filter.



- Final-stage, round replacement HEPA filter that captures 99.97% of airborne contaminants as small as 0.3 microns
- The H610C-99 removes bacteria, mold spores, soot, pollens, animal hair and dander, dust mites, smoke particles, other allergens and lung damaging particles
- It is recommended you change the final filter every two to three years under normal operating conditions

PART NO.	DESCRIPTION
8.697-383.0	HEPA Filter PRED 1200

## PREDATOR 1200 PORTABLE AIR SCRUBBER

The new, state-of-the-art rotational-molded HEPA filtration systems.



- High-density polyethylene cabinet is strong and durable; resin includes microbial growth and UV inhibitors
- Powerful - provides more airflow per pound than other products
- Lightweight (70 lbs) and portable, superior mobility for vehicle loading / unloading and easy rolling to the job site
- Low-amperage draw, safely 'daisy-chain' up to three units on one 115V / 15-Amp circuit
- True 99.97% HEPA filtration, Type A HEPA tested and certified to IEST construction and testing standards; microglass media does not rely on an electrostatic charge to maintain efficiency; two pre-filter stages; optional third stage
- Economical to operate

PART NO.	DESCRIPTION
8.697-384.0	Predator 1200 Portable Air Scrubber

## PREDATOR 600 PORTABLE AIR SCRUBBER

The world's lightest and smallest PAS with the performance and features you need.



- Incredibly lightweight and compact – weighs just 34 lbs including filters, about 10 lbs lighter than any other PAS
- Powerful – variable-speed airflow, rated at 200 to 600 cfm. PRED 600 is the smallest 600 cfm unit on the market
- Special cabinet resin – cabinets made from a high-density polyethylene resin that contains microbial growth and UV inhibitors, and the Tefgard™ finish is easy to clean and decontaminate
- Effective filtration – comes with two pre-filters and a true 99.97% HEPA filter. Vapor-Lock® carbon pre-filter is optional
- Economical to operate – filters last longer and cost less. You can save hundreds of dollars in replacement filter costs
- Secure stacking – multiple units nest securely together to save space when stacked in a warehouse, a van or on the job. They can even run when stacked
- Low-amperage draw – up to five units can be safely daisy-chained on one 15-Amp circuit (total current draw 12 Amps)

PART NO.	DESCRIPTION
8.697-385.0	Predator 600 Portable Air Scrubber

## ZIPWALL 12' POLES, 2 PK

Two spring-loaded poles, extends from 4'-7" to 12'; includes two sets of parts (head, plate, tether, GripDisk™)



- The six SLPTM poles extend from 4'-9" to 12'
- The poles can be placed 8 to 10 feet apart. If there is any significant air movement that pushes the plastic, you will want to pull them in closer together
- The GripDisk™ slide stoppers should always be used, especially on hard surfaces
- Six GripDisk™ slide stoppers come in every package

PART NO.	DESCRIPTION
8.697-368.0	ZipWall 12' Poles, 2/Pk

## ZIPWALL CARRIER BAG

Sturdy, durable. Can hold 12 SLPs or six 20' poles with jacks unattached.



- Made of tough polyester
- Keeps all your barrier products organized and easy to transport

PART NO.	DESCRIPTION
8.697-366.0	ZipWall Carrier Bag

## ZIPWALL SIDE CLAMP, 2 PK

Two side-clamp wall mounts.



- Each side-clamp wall mount is made of polycarbonate and is very tough
- This product can easily fit into the ZiWall® carry bag with poles and Foam Rail™ cross bars
- In some situations where you have large crown moldings and base board heat on the same wall, the pole may be too far from the wall for the side-clamp wall mounts to reach

PART NO.	DESCRIPTION
8.697-365.0	ZipWall Side Clamp, 2/Pk

## DUCKBILL SNIPPING SHEARS

Unique duckbill blade designed for precision cuts.



- Offset handle for easy-level nap trimming
- 7"

PART NO.	DESCRIPTION
8.697-060.0	Duckbill Napping Shears, 7"

Specifications, product descriptions and product availability subject to change without notice.

## ZIPWALL ZIPPER

Includes two self-adhesive zippers and two cords for tying up a plastic flap. For indoor-use only.



- Makes an easy doorway through plastic barriers
- Designed by the manufacturers of the award-winning ZipWall® dust barrier systems
- Has the smoothest glide available
- Is engineered with large, sturdy easy-slide teeth
- Is made with two-sided pulls for easy entry, exit to or from the barrier
- Works best in temperatures above 55°F

PART NO.	DESCRIPTION
8.697-363.0	ZipWall Zipper

## PRESSURIZED DRYING SYSTEM - 21

Viking's new patent-pending pressurized drying systems makes drying wall cavities easier and less frustrating than before.



Perfect for under sinks, behind cabinets and permanent furniture. Its portability makes drying a breeze. All-in-one containment provides the operator with simple on-the-go equipment. Just bore a 1/2" hole, plug in the end hose and begin drying. An on-board plug-off system makes plugging unused tubes simple.

PART NO.	DESCRIPTION
8.697-129.0	Pressurized Drying System-21

## LEGACY AIR MOVER (LAM3)



Powerful up to 3000 CFM, lightweight, versatile three-speed air mover reduces carpet drying times by up to 50%

- Durable polyethylene gray housing with a sturdy four-point motor mount
- Easy to carry and move. Lightweight with a balanced offset handle
- 120V AC 60hz, 9 Amp with molded cord hooks for storing the 25' 16/3
- 1/2 HP thermally protected continuous duty motor with capacitor start and four-point mount
- Built-in carpet clip makes it easy to dry floor under carpet - ideal for restoration work



PART NO.	DESCRIPTION
1.004-014.0	Legacy Air Mover

**AIR KING PIVOTING HIGH-VELOCITY**

The Pivoting Blowers are a perfect fit for any job site. The compact size makes them a great fit where space is tight.



- Pivoting High-Velocity Blower features a pivoting head to direct air flow where you need
- With a type SO, GFCI power cord with test and reset buttons
- The 1/3 HP blower delivers just the amount of air flow you need
- Dimensions: 13" L x 11" W x 14.5" H
- Weight: 12.75 lbs

PART NO.	DESCRIPTION
8.697-205.0	Air King Pivoting High-Velocity

**CARPET INSTALLATION & REPAIR**

**AVIATION SNIPS FOR MOST METALS**

A high-quality, imported 10" snips with alloy steel handles.



- Alloy steel handles
- Hot-forged molybdenum steel blades
- Makes straight cuts 1-1/2" long in metal up to 18 gauge (.049") thick
- Vinyl grips for comfort

PART NO.	DESCRIPTION
8.697-068.0	Aviation Snips

**EZ MOVES PRO**

Set of four.

**11.5" x 6.75"**



- Used by moving men, carpet installers, carpet cleaners, painters, remodelers, store owners, janitorial services, interior designers and more

PART NO.	DESCRIPTION
8.697-027.0	EZ Moves Pro

**EZ MOVES HARD SURFACE PRO**

For heavy moving on hards floors (4 Pkg).

**5-3/4" x 9-1/2"**



- An accessory for your EZ Moves II™ to provide extra protection when moving items across hard surfaces

PART NO.	DESCRIPTION
8.697-026.0	EZ Moves Hard Surface Pro

**PERFECT PATCH**

Easiest way to repair carpet.



- The 3-in-1 Perfect Patch tool is the easiest way to repair carpet and it comes with a FREE how-to-patch a carpet video

PART NO.	DESCRIPTION
8.697-392.0	White Chalk

**HOSES, CONNECTORS AND ACCESSORIES**

**BALL SHUT-OFF VALVE 1/4"**

Replacement Econo shut-off valve.



- Use this ball valve on your solution hose
- Fits 1/4" fittings

PART NO.	DESCRIPTION
8.697-347.0	Ball Shut-Off Valve, 1/4"

**PREMIUM BALL SHUT-OFF VALVE**

Replacement shut-off ball valve.



- Premium quality built into this shut-off valve

PART NO.	DESCRIPTION
8.697-125.0	Premium Ball Shut-Off Valve, 1/4"

**CHROME BALL VALVE**



- PSI: 1000
- Temperature: 300° M/F
- "T"-Handle Valve

PART NO.	DESCRIPTION
8.697-414.0	Chrome Ball Valve, 1/4"

### CONNECTOR 1.5" - 2" STAINLESS-STEEL

Durable stainless-steel vacuum hose connector.



- Connects 2" vacuum hose cuff to 1.5" hose cuff

PART NO.	DESCRIPTION
8.697-076.0	Connector, 1.5" - 2", Stainless-steel

### CONNECTOR 1.5" - 2" STAINLESS-STEEL

Durable stainless-steel vacuum hose connectors for connecting two lengths of 1.5" vacuum hose.



- Connects two sections of 1.5" vacuum hose

PART NO.	DESCRIPTION
8.697-075.0	Connector, 1.5", Stainless-steel

### CONNECTOR 2" STAINLESS-STEEL



- Durable stainless-steel vacuum hose connectors for connecting two lengths of 2" vacuum hose

PART NO.	DESCRIPTION
8.697-078.0	Connector, 2", Stainless-steel

### CONNECTOR: BARB HOSE 2" - 1.5"



- 1.5" barb x 2" barb

PART NO.	DESCRIPTION
8.697-348.0	Connector, Barb Hose, 2" - 1.5"

### CONNECTOR: BARB HOSE 1.5" - 1.5"



- 1.5" barb x 1.5" barb connector

PART NO.	DESCRIPTION
8.697-345.0	Connector, Barb Hose, 1.5" - 1.5"

### CONNECTOR: BARB HOSE 2" - 2"



- 2" barb x 2" barb connector

PART NO.	DESCRIPTION
8.697-346.0	Connector, Barb Hose, 2" - 2"

Specifications, product descriptions and product availability subject to change without notice.

### COUPLER: 1/4" FEMALE, SECURE LOCK



- Coupler, 1/4" Female

PART NO.	DESCRIPTION
8.697-085.0	Coupler, 1/4" Female, Secure Lock

### COUPLER: 1/4" FEMALE



- Parker quick-connect

PART NO.	DESCRIPTION
8.697-079.0	Coupler, 1/4" Female

### COUPLER: 1/4" FEMALE STAINLESS-STEEL



- Durable stainless-steel female replacement coupler

PART NO.	DESCRIPTION
8.697-087.0	Coupler, 1/4" Female, Stainless-steel

### COUPLER: QUICK CONNECT 1/4" F ECONO

Female 1/4" econo replacement QD.



- Interchangeable with other manufacturer's fittings

PART NO.	DESCRIPTION
8.697-350.0	Coupler, Quick Connect, 1/4" Female, Econo

### COUPLER: 1/4" MALE QC ECONO

Coupler 1/4" male quick-connect, economy.



- Directly interchangeable with your worn out brass or stainless-steel couplers

PART NO.	DESCRIPTION
8.697-080.0	Coupler, Quick-Connect, 1/4" Male, Econo



### COUPLER: 1/4" MALE STAINLESS-STEEL

Coupler 1/4" male quick-connect, economy.



- Parker Hannifin coupler 1/4" male quick-connect

PART NO.	DESCRIPTION
8.697-086.0	Coupler, 1/4" Male, Stainless-steel

### COUPLER: 1/4" MALE QUICK CONNECT PH



- High-quality, long-life Parker Hannifin brand coupler

PART NO.	DESCRIPTION
8.697-081.0	Coupler, 1/4" Male, Quick Connect PH

### HIDE-A-HOSE SWIVEL CUFF

Vinyl hide-a-hose swivel cuff.



- Now you can hide your solution within the vacuum hose line, and you can forget the hassles of trying to work with separate hoses lying all around

PART NO.	DESCRIPTION
8.697-351.0	Hide-A-Hose Swivel Cuff, 2"
8.697-349.0	Hide-A-Hose Swivel Cuff, 1.5"

### SWIVEL CUFF: BIG END THREADED



- 1.5" to 2"

PART NO.	DESCRIPTION
8.708-903.0	Big End Threaded, 1.5"
8.708-904.0	Big End Threaded, 2"
8.708-905.0	Swivel Cuff, 1.5"
8.708-906.0	Swivel Cuff, 2"

### HOSE CUFF 1.5" - 2" SMALL END THREADED

Vinyl enlarger.



- 1-1/2" vinyl screw cuff enlarged to accommodate
- 2" O.D. wand connection

PART NO.	DESCRIPTION
8.697-091.0	Hose Cuff, 1.5" - 2" Small End Threaded

### HOSE CUFF 2" SWIVEL REDUCER



- 2" vinyl swivel reducer cuff

PART NO.	DESCRIPTION
8.697-093.0	Hose Cuff, 2" Swivel Reducer

### HOSE CUFF 2" - 1.5" BOTH ENDS THREADED



- 2" - 1.5" vinyl double threaded connector

PART NO.	DESCRIPTION
8.697-095.0	Hose Cuff, 2" - 1.5" BET

### MISC HOSE CUFFS AND ACCESSORIES

PART NO.	DESCRIPTION
8.708-896.0	Hose Connector, 1.5" - 1.5"
8.708-900.0	Hose Cuff, 2" Threaded Reducer
8.708-898.0	Hose Cuff, 2" - 2" Both Ends Threaded

### HOSE HOOK 1.5

Hose Hook 1.5" to 3".



- Hook: 1/4" diameter, 1-1/4" radius bend (2-1/2" opening)
- Can hook on larger objects
- Coated to prevent scratches
- Fits 1-1/2" to over 3" hoses

PART NO.	DESCRIPTION
8.697-100.0	Hose Hook, 1.5"

### HOSE HUGGER 3 X 27



- 3 x 27" for 25' plus of 1-1/2" vacuum hoses

PART NO.	DESCRIPTION
8.697-122.0	Hose Hugger, 3 x 27"

### HOSE HUGGER 3 X 34



- 3 x 34" for larger diameter vacuum hoses

PART NO.	DESCRIPTION
8.697-121.0	Hose Hugger, 3 x 34"

### CORD HUGGER 3 X 12



- For light-duty electric cords up to 100'
- Clear the clutter and tangles with this handy accessory

PART NO.	DESCRIPTION
8.697-120.0	Cord Hugger, 3 x 12"

### D-RING HANDI TIE 1.5



- An all-purpose tie for power cords and solution hoses
- Keep them with the tool or appliance

PART NO.	DESCRIPTION
8.697-099.0	D-Ring Handi Tie, 1.5"

### SNAP N LOCK CUFF

Snap N Lock hose connector set.



- Stainless-steel button locks
- Positive locked connection
- High-impact, safety-yellow plastic
- Durable in hot or cold climates
- Fracture-resistant

PART NO.	DESCRIPTION
8.697-408.0	Snap N Lock Cuff, 1.5" - 1.5"
8.697-410.0	Snap N Lock Cuff, 2" - 1.5"
8.697-407.0	Snap N Lock Cuff, 2" - 2"

### SNAP N LOCK CUFF 2"

Snap N Lock 2" leaf trap adapter.



- Stainless-steel button locks
- Positive locked connection
- High-impact, safety-yellow plastic
- Durable in hot or cold climates
- Fracture-resistant

PART NO.	DESCRIPTION
8.697-409.0	Snap N Lock Cuff, 2"

### TANDEM HOSE CLAMP



- For keeping hoses connected
- Tandem hose clamp
- 2" wide strap
- Adjustable

PART NO.	DESCRIPTION
8.697-101.0	Tandem Hose Clamp

### SOLUTION HOSE REEL

Solution reels provide convenient storage for high-pressure solution hose and garden hose.



- Will accommodate up to 150' of 5/8" garden hose or 450' for 1/4" high-pressure hose
- Standard solution reels come in two sizes and come equipped with an angle bracket that bolts directly on to our vacuum hose reels
- All welded-steel construction with rust-resistant paint finish make it an attractive asset to any truck-mounted cleaning system

PART NO.	DESCRIPTION
8.697-070.0	Solution Hose Reel, 100', 5/8" / 300', 1/4"

### SOLUTION HOSE 50', 1/4", 3000 PSI

High-temperature, high-pressure solution hose.



- PSI: Up to 3000
- Temperature: Up to 250°F
- 50 feet, steel-braided
- Tight-bend radius capability
- 1/4" male swage fittings and a black poly heat shield

PART NO.	DESCRIPTION
8.918-062.0	Solution Hose - Blue

### SOLUTION HOSE 50', 1/4", 1500 PSI

High-temperature, high-pressure solution hose.



- PSI: Up to 1500
- Temperature: Up to 250°F
- 50 feet, gray, steel-braided
- Tight-bend radius capability
- 1/4" male swage fittings and a black poly heat shield

PART NO.	DESCRIPTION
8.918-074.0	Solution Hose - Blue
8.918-063.0	Solution Hose - Gray

### SOLUTION HOSE 50', 3/8", 3000 PSI

High-temperature, high-pressure solution hose.



- PSI: 3000
- Temperature: 250°F
- 50 feet of 3/8" Goodyear high-pressure solution line, steel-braided
- For pressure washing or other equipment that requires more water flow
- Plastic Heat Sleeve

PART NO.	DESCRIPTION
8.739-148.0	Solution Hose - Blue

### TRUCK-MOUNT HOSE, HEAVY-DUTY GRAY

Hose, 25' or 50' heavy-duty, truck-mount vacuum hose, gray with cuffs.



- The combination of co-polymer materials and two-part helically-wound construction make this hose superior to others in the market
- Pro-Flex™ has all the characteristics users look for in a vacuum hose plus many added features such as ultraviolet protection, crush-resistance, smooth bore and much more.

PART NO.	DESCRIPTION
8.697-114.0	Truck-Mount Vacuum Hose, 50', 1.5"
8.697-118.0	Truck-Mount Vacuum Hose, 50', 2"

### TRUCK-MOUNT HOSE, HEAVY-DUTY BLUE

Hose, 25' or 50' heavy-duty, truck-mount vacuum hose, blue with cuffs.



- The combination of co-polymer materials and two-part helically-wound construction make this hose superior to others in the market
- Pro-Flex™ has all the characteristics users look for in a vacuum hose plus many added features such as ultraviolet protection, crush-resistance, smooth bore and much more.

PART NO.	DESCRIPTION
8.697-112.0	Truck-Mount Vacuum Hose, 50', 1.5"
8.697-117.0	Truck-Mount Vacuum Hose, 50', 2"

### VACUUM HOSE REEL

These storage reels offer the advantage of using a reel as an effective piece of operating equipment rather than a simple device for the storage of hose.

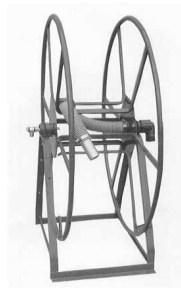

- All storage reels feature custom-fabricated UHMW bearings. UHMW is a plastic compound that will provide trouble-free service
- All reels are pre-drilled to accept our solution reels which are simply bolted on
- All reels are equipped with a positive spool stop
- All reels are welded-steel construction and finished with rust-resistant paint

PART NO.	DESCRIPTION
8.697-072.0	Vacuum Hose Reel, 200'
8.697-073.0	Vacuum Hose Reel, 250'
8.697-074.0	Vacuum Hose Reel, 300'

### FAUCET KIT ADAPTER



- Universal faucet adapter

PART NO.	DESCRIPTION
8.697-406.0	Faucet Kit Adapter

## DOUBLE HOSE REEL STAND

Self-supporting, dual hose reel stand.



- Single Stand
- Self-Supporting
- Can use to make reel portable or to simplify installation
- Accommodates live operation of the reel

PART NO.	DESCRIPTION
8.697-420.0	Hose Reel Stand

## BRUSHES

### SWIVEL GROUT BRUSH

Swivel grout brush 1" x 8".



- The fibers on this brush are trimmed to a chisel edge to allow the brush to scrub aggressively along grout lines
- The stiff black fiber will stand up to tough use
- Uses standard-threaded handle (not included)

PART NO.	DESCRIPTION
8.697-287.0	Swivel Grout Brush

### NAP BRUSH

Nylon, white, stiff napping brush used to remove swirl marks from the rotary action of machines, foot prints or even equipment wheel tracks.



- Shade the nap in one direction to give the carpet a neat, finished appearance
- Featherweight brush is 19" wide with three rows of 1-1/2" long nylon bristles
- designed to not streak
- Very strong, yet lightweight, which eliminates job fatigue and helps the job go faster

PART NO.	DESCRIPTION
8.697-320.0	Nap Brush

## GROOMERS

### GRANDI BRUSH

Designed to give maximum penetration on commercial-grade level and multi-loop carpets.



- The Grandi Brush features a single row of nylon fibers that have been designed to give maximum penetration on commercial-grade level and multi-loop carpets
- You can agitate pre-sprays as well as protectors to get optimum performance from your carpet cleaning chemicals

PART NO.	DESCRIPTION
8.697-009.0	Grandi Brush

### GRANDI BRUSH (HEAD ONLY)



- No handle

PART NO.	DESCRIPTION
8.697-011.0	Grandi Brush, Head Only

### GRANDI GROOM

Perfect for multi-level carpet pile.



- 18" Wide Head
- Ideal for agitating pre-spray into the carpet
- Excellent for working protector into the carpet

PART NO.	DESCRIPTION
8.697-012.0	Grandi Groom

### GRANDI GROOM (HEAD ONLY)



- No Handle

PART NO.	DESCRIPTION
8.697-019.0	Grandi Groom, Head Only

### HANDI BRUSH

This short, soft bristle brush is excellent for upholstery, velvet, oriental rugs or any other fine fabric.



- Use before cleaning to lift nap and remove lint, pet hair or other debris
- Use after cleaning to lift nap

PART NO.	DESCRIPTION
8.697-014.0	Handi Brush

**GRANDI GROOM CONVERSION**

Convert your Grandi Groom to include the Grandi Brush head.



- The Grandi-Groom Conversion Kit consists of the Grandi Brush head with dual-head connector to attach to your existing Grandi Groom to create a two-headed grooming tool
- The Grandi Brush features a single row of nylon fibers that have been designed specifically to give maximum penetration on commercial grade level and multi-loop carpets
- You can agitate pre-sprays as well as protectors to get optimum performance from your carpet cleaning chemicals
- The Grandi Brush can be combined with the classic Grandi Groom to create the Grandi / Brush Combo
- With the conversion kit, you can create a two-headed grooming tool that adapts easily to any type of carpet

PART NO.	DESCRIPTION
8.697-013.0	Grandi Groom Conversion

**HANDI GROOM BRUSH**

Plastic bristles agitate pre-spray and protectants on stairs and hard-to-reach areas. Ideal for use in spot dyeing.



- Lightweight plastic bristle hand brush designed as a pile conditioner for carpeting on stairs and in tight places.
- Excellent for restoring the appearance and texture of high-pile area rugs, fringes even sweaters
- Compact and handy, but strong enough for stubborn dirt

PART NO.	DESCRIPTION
8.697-015.0	Handi Groom Brush

**CONTAINERS**

**MEASURING CUPS**



- Cups are calibrated for exact measurements

PART NO.	DESCRIPTION
8.697-021.0	Measuring Cups - 16 oz
8.697-024.0	Measuring Cups - 8 oz

**MEASURING CUPS, 2 OZ**



PART NO.	DESCRIPTION
8.697-022.0	Measuring Cup - 2 oz

**SPOTTING BOTTLE**

Plastic spotting bottle with lid.



- Sprayer bottles and sprayers are perfect for chemicals and cleaners

PART NO.	DESCRIPTION
8.697-007.0	Spotting Bottle - 4 oz

**MISC ACCESSORIES**

**WALL BUDDY**

The ultimate solution in corner protection.



- Can be used in the carpet cleaning, janitorial and painting industries
- Protects all of the corners of the walls and furniture on your job
- Portrays a Professional image which reassures your customer that you care
- Protects against costly insurance claims due to damaged corners or walls
- Made from a lightweight, non-marking durable plastic
- Can be sold to customers who have central vacuum systems

PART NO.	DESCRIPTION
8.697-425.0	EZ Fill Container

**DRUM PUMP**

Siphon drum pump.



- Made from polyethylene
- Fits 15, 30 and 55 gallon drum with 2" national pipe thread

PART NO.	DESCRIPTION
8.704-696.0	Drum Pump

**STYROFOAM BLOCKS, WHITE**



- PSI: 2.0
- 1,008 Per Case
- White styrofoam

PART NO.	DESCRIPTION
8.697-003.0	Styrofoam Blocks - White



## STYROFOAM BLOCKS, BLUE

Premium blue styrofoam blocks. The best block money can buy!



- Blue blocks are the very best, especially for the heaviest furniture
- These 2" x 2" x 1" blocks have the highest compressive strength available and will never crush
- Will never leave a mess as it always snaps off cleanly
- 1,008 per case

PART NO.	DESCRIPTION
8.697-001.0	Styrofoam Blocks - Blue

## PLASTIC PROTECTOR PADS, 1000/CS

Furniture protection solution.



- The solution for protecting furniture legs from moist carpet
- Each box contains two blocks of 425 and one block of 150
- Clear plastic, completely moisture-proof

PART NO.	DESCRIPTION
8.697-028.0	Plastic Protector Pads, 1000/cs, 3 x 3
8.697-030.0	Plastic Protector Pads, 1000/cs, 4 x 4

## SAFETY ITEMS

### BOOT HAZMAT / FLOOD

Yellow hazmat, flood boots.



- Great foot protection against muddy and watery conditions in many different types of environments and workplaces

PART NO.	DESCRIPTION
8.697-131.0	Boot Hazmat, Flood, X-Large
8.697-132.0	Boot Hazmat, Flood, XX-Large

### DISPOSABLE NITRILE GLOVES

Powdered, nitrile disposable gloves.



- Powdered, nitrile, rolled cuff
- Meets FFDC requirements for food contact
- Ambidextrous
- Greater tactile feel over other latex alternatives
- 100 per box

PART NO.	DESCRIPTION
8.697-145.0	Disposable Nitrile Gloves, Large
8.697-146.0	Disposable Nitrile Gloves, Medium
8.697-147.0	Disposable Nitrile Gloves, X-Large

Specifications, product descriptions and product availability subject to change without notice.

## KNEE PADS

Save your knees – buy these.



- One size fits all
- Quality construction with comfort in mind
- Quick-release snaps

PART NO.	DESCRIPTION
8.697-150.0	Knee Pads

## VINYL DISPOSABLE GLOVES

Seamless, vinyl, latex-free disposable gloves.



- Latex-Free
- Ambidextrous
- Lightly Powdered
- Rolled Cuff
- 100 Per Box
- Meets FFDC requirements for safe food handling

PART NO.	DESCRIPTION
8.697-148.0	Vinyl Disposable Gloves, Medium

## NITRILE FLOCK-LINED GLOVES

Strong, chemical-resistant nitrile gloves. Price per dozen.



- Green 15 mil
- 12" nitrile flock lining
- Strong, chemical-resistant, including petroleum-based products
- Meets FFDC requirements for food contact

PART NO.	DESCRIPTION
8.697-143.0	Nitrile Flock Lined Gloves, Medium
8.697-144.0	Nitrile Flock Lined Gloves, X-Large

## SHOE COVERS, BLUE

Large, 100% polypropylene, blue shoe covers.



- White tread for traction
- Elastic opening for a snug fit around the ankle

PART NO.	DESCRIPTION
8.697-432.0	Shoe Covers, X-Large, Box - 300

## SHOE COVERS, WHITE



- 200 / cs

PART NO.	DESCRIPTION
8.697-139.0	Shoe Covers, White

## MAXSHIELD COVERALLS, HOOD AND BOOTS

Coverall come complete with hood and elasticized boots.



- Medium, Large, X-Large and XX-Large

PART NO.	DESCRIPTION
8.697-156.0	Coverall with Hood and Boots, Medium
8.697-155.0	Coverall with Hood and Boots, Large
8.697-157.0	Coverall with Hood and Boots, X-Large
8.697-158.0	Coverall with Hood and Boots, XX-Large

## SAFETY GLASSES, AMBER

Amber lens safety glasses.



- These safety glasses are the next generation in super-cool, low-cost protective eyewear
- Ultra-fashionable impact protection that meets and exceeds ANSI Z87.1+ standards

PART NO.	DESCRIPTION
8.697-140.0	Safety Glasses, Amber

## SAFETY GLASSES, CLEAR

Clear lens, wrap-around safety glasses.



- Adjustable templates for length and flexibility
- Lightweight and comfortable to wear
- Meets Z87.1 safety standards

PART NO.	DESCRIPTION
8.697-142.0	Safety Glasses, Clear

## SPLASH-PROOF SAFETY GLASSES

Chemical splash goggle.



- Frame material – PVC plastic
- Lens material – polycarbonate
- Lens coatings – Duramass® scratch-resistant hard coating
- Lens thickness – .060 mm
- Strap – rubber (rubber straps on the protective goggles are latex-free)
- Style – indirect ventilation for chemical splash
- Replacement lenses available
- All lenses provide 99.9% UV protection
- Meets or exceeds ANSI Z87.1+ safety standard
- Light transmissions – Clear, 85%

PART NO.	DESCRIPTION
8.697-141.0	Splash Proof Safety Glasses

## RESPIRATOR, FULL-FACE

MSA full-mask respirator.



- The MSA reusable, full facepiece, offers users comfort and convenience, as well as, cost-savings
- The facepiece is made of a thermoplastic elastomer, making it remarkably comfortable, soft and lightweight
- This is the MSA full-face mask only, filters and cartridges sold separately

PART NO.	DESCRIPTION
8.697-369.0	Respirator Full-Face, Large

## RESPIRATOR, HALF-FACE, LARGE

Advantage half-mask respirator, size large.



- Offers unmatched fit and comfort with a clear blue facepiece
- The patented MultiFlex® System equalizes pressure on the face-seal area, while delivering exceptional stability so the respirator will not collapse during wear
- The thermoplastic rubber subtracts 25% of the weight and adds softness to MSA's Advantage 200 LS respirator
- The AnthroCurve sealing surface instantly conforms to each wearer's unique facial characteristics. Current Advantage 200 respirator wearers require no additional fit testing

PART NO.	DESCRIPTION
8.697-152.0	Respirator Half-Face, Large

## ORGANIC VAPOR RESPIRATOR SET CARTRIDGE

Chemical cartridges for Advantage respirators.



- NIOSH-approved for respiratory protection against vapors
- Meets OSHA requirements for an approved cartridge

PART NO.	DESCRIPTION
8.697-133.0	Organic Vapor Respirator Set Cartridge

## DISPOSABLE CAUTION SIGN

Inexpensive way to show your customers their safety is your primary concern.



- An inexpensive way for carpet cleaners to help keep customers safe
- Because these signs are inexpensive, cleaners can leave them on the job to show customers they care about their safety
- 21" long, folds into an 11 x 6.5 wide triangle

PART NO.	DESCRIPTION
8.697-428.0	Disposable Caution Sign

## WANDS AND UPHOLSTERY TOOLS

### DUAL-JET WAND

12" head, 1100 PSI, 60" length.



- 2-jet design uses standard 11002 T-jets
- Side splashguard helps to contain overspray
- Stainless-steel solution hose
- Full-flow vacuum extraction
- Precision nozzles for best performance

PART NO.	DESCRIPTION
8.697-192.0	Dual Jet Wand

### LOW-PROFILE WAND, 4-JET

If you want your wands to utilize the full potential of your truck mount's blower to get the fastest drying time, then this is the wand for you.



- 4-jet design uses standard V-jets 95015
- Side splashguard helps to contain overspray
- Goodyear, 3000 PSI solution hose
- Full-flow vacuum extraction
- Precision nozzles for best performance
- 2" tube

PART NO.	DESCRIPTION
8.697-191.0	Low Profile Wand 4-Jet, 12"

### GUM BLASTER

This 4" wonder tool does it all. Its double-bend design makes it an easy, comfortable wand to use.



- All stainless-steel
- 800 PSI brass valve
- Closed-spray chamber
- Padded assist handle
- Stainless-steel solution line

PART NO.	DESCRIPTION
8.697-193.0	Gum Blaster

### DETAIL TOOL K-800 PSI VALVE W-WHIP CLOSED



- 4" wide vacuum path
- Smooth head for improved suction
- Full-flow vacuum extraction
- Precision nozzles for best performance

PART NO.	DESCRIPTION
8.697-182.0	Detail Tool, K-800PSI, Valve with Whip Closed

### PADDED ASSIST HANDLE



- 1.5" and 2" Handles

PART NO.	DESCRIPTION
8.697-188.0	Padded Assist Handle, 1.5"
8.697-190.0	Padded Assist Handle, 2"

### STAIR WAND 22" STRAIGHT

22" straight with 2" flair tube. This stair tool's design and its high-pressure water and steam enable you to remove ground-in dirt on stairs from a standing position.



- 2-jet design uses standard 11002 T-jets
- Side splashguard helps to contain overspray
- Stainless-steel solution hose
- Full-flow vacuum extraction
- Precision nozzles for best performance

PART NO.	DESCRIPTION
8.697-195.0	Stair Wand, 22", Straight

### SWIVEL-HEAD ERGONOMIC STAIR TOOL 30"

Open spray, 500 PSI



- PSI: 500
- V2P Brass Valve
- Padded-Assist Handle
- Head swivels easily and stays in rotated position
- 1-Jet Brass Vee Jet
- Perfect height for cleaning stairs

PART NO.	DESCRIPTION
8.697-200.0	Swivel-Head, Ergonomic Stair Tool, 30"

### UPHOLSTERY TOOL 4", CLOSED

Precision nozzles for best performance. Smooth 4" vacuum path head for improved suction.



- Tube Diameter: 1.5"
- Head Width: 4"
- Length: 10"
- Nozzles: 2503 or 2504
- Valve: K 105
- PSI: 800
- Weight: 1.5 lbs
- Fill-low vacuum extraction

PART NO.	DESCRIPTION
8.697-186.0	Upholstery Tool, 4", Closed

### WINDOW WASHING BUCKET, 6 GALLON

Heavy-duty bucket with ergonomic handle for glass cleaning. Accommodates 18" washers and squeegees.



- Heavy-duty, 6-gallon bucket with large footprint for increased stability
- Easily fits 18" washer
- Rounded pour spouts on two corners make it easy to empty with more control
- Ergonomically-designed handle for comfort is stiffer and more stable for balance when carrying
- Use with optional snap-on lid and castors or bucket barge

PART NO.	DESCRIPTION
8.697-323.0	Window Washing Bucket, 6 Gallons

### ERGOTEC SAFETY SCRAPER 1.5"

Sturdy snap-on lid for Pro-Bucket.



- Unique locking system eliminates blades from sliding out while working
- Uses standard No. 9 (1-1/2") razor blades (not included)
- Includes all the features of the SafetyScraper with the added comfort of the new ergonomic grip
- Rubber grip prevents scraper from slipping inhand which makes removing soil from surfaces even easier

PART NO.	DESCRIPTION
8.697-284.0	ErgoTec Safety Scraper, 1.5"

### SCRAPER BLADES, 100 BLADES / PK

Safety scraper replacement blades.

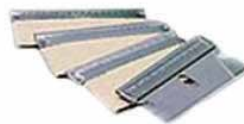

- Razor sharp No. 9 (1-1/2") standard blade for removing dirt
- Packed in a convenient reclosable plastic tray so blades are kept safe and dry to prevent rusting

PART NO.	DESCRIPTION
8.697-183.0	Scraper Blades, 100 Blades Per Pack

### T-BAR ERGOTEC®

Ergonomic T-bar with polypropylene handle.



- Features an ergonomic, two-component polypropylene handle for less strain and more control
- Water wells for high-water retention
- Attaches to poles with a press fit for out-of-reach cleaning

PART NO.	DESCRIPTION
8.697-293.0	T-Bar ErgoTec, 14"

### S-CHANNEL WITH SOFT SQUEEGEE

Stainless-steel "S" channel complete with ErgoTec soft replacement squeegee.



- Strong, long-lasting and rust-free stainless-steel construction
- Fits on ErgoTec, ProStainless-steel and GoldenPro squeegees
- Notched-channel system will not slip, wobble or bend

PART NO.	DESCRIPTION
8.697-285.0	S-Channel with Soft Squeegee, 6", 10 Per Pack

### SQUEEGEE SOFT, 10 PK

Soft squeegee for window cleaning in reclosable blister pack.



- Ideal for cooler temperatures
- Conforms to uneven surfaces
- Better glide with streak-free performance
- Longer lasting, superior packing
- Comes in 10 pk

PART NO.	DESCRIPTION
8.697-283.0	Squeegee Soft, 10 Per Pack, 18"
8.697-277.0	Squeegee Soft, 10 Per Pack, 12"
8.697-272.0	Squeegee Soft, 10 Per Pack, 6"

### SQUEEGEE SOFT PROMO, 25 PK

PromoPack soft rubbers in storage box.



- 12" soft rubbers in each pack, 25 pack
- Free box for storing rubbers and channels
- Reusable, adjustable UV-resistant plastic tube protects against dampness

PART NO.	DESCRIPTION
8.697-275.0	Squeegee Soft Promo, 25 Per Pack, 12"



# Hot Water Pressure Washer Comparison Chart

## HDS UPRIGHT



## HOT



## PHW



## MHC







## PGDC



	HDS UPRIGHT	HOT	PHW	MHC	PGDC
<b>Power Type</b>	Electric	Electric	Electric	Gasoline	Gasoline
<b>EASY!Force Trigger Gun</b>					
<b>Landa 5000 PSI Trigger Gun</b>					
<b>4 Hardened Stainless Steel Nozzles (0°,15°,25°,40°)</b>		15° only			
<b>Durable Variable Pressure Wand</b>					
<b>2-Wire Landa Hose Rated for 6000 PSI</b>					
<b>Heating Source</b>	Diesel	Diesel	Diesel	Diesel	Diesel
<b>Diesel tank capacity (gal)</b>	2	5-6	10	10	9.25
<b>Diesel Burner Voltage</b>	120V	120V - 230V AC	120V - 230V AC	12V DC	12V DC
<b>Adjustable Thermostat</b>					
<b>LP Gas Conversion</b>					
<b>Pump Drive</b>	Direct	Direct or Belt	Belt	Direct or Belt	Belt
<b>Triplex Landa Pump with 7 year warranty</b>					
<b>Axial High-Pressure Pump with 7-Year Warranty</b>					
<b>AC Voltmeter</b>					
<b>Auto Start/Stop</b>					
<b>Caster Wheel Kit</b>					
<b>Cool-Bypass (Patent US 8,496,188 B2)</b>					
<b>Downstream Detergent Injector</b>					
<b>Electrical Generator</b>					
<b>Electronic Ignition (no standing pilot light)</b>					
<b>Fuel Cap and Gauge</b>					
<b>Ground Fault Circuit Interrupter (1-phase only)</b>					
<b>High-Pressure Detergent Injection</b>					
<b>Hour Meter</b>					
<b>Wireless Remote</b>					
<b>Magnetic Start Switch</b>					
<b>Oil/Water Separator in Fuel Line</b>					
<b>Polyethylene Float Tank</b>					
<b>Stainless Steel Coil Wrap</b>		*			
<b>Time Delay Shutdown</b>					
<b>Tru-Tite System</b>					
<b>Tru-Trac Technology</b>					
<b>Vibration Isolated Platform</b>					
<b>Wet-Steam Combination</b>					

Standard Feature    Available Feature    \* Applies to specific models within series    \*\* Standard for gasoline models, optional for diesel





Cold Water Pressure Washer Comparison Chart	Denali	Jarvis HD	HD 7.9/72-4 Cage Ec	HD Gas	MP
					
Power Type	Gasoline	Gasoline	Gasoline	Gasoline	Gas or Diesel
EASY!Force Trigger Gun		*			*
Landa 5000 PSI Trigger Gun					*
4 Hardened Stainless Steel Nozzles (0°,15°,25°,40°)					
Durable Variable Pressure Wand					*
2-Wire Landa Hose Rated for 6000 PSI					
Pump Drive	Belt	Direct	Direct	Belt or Direct	Belt
Triplex Landa Pump with 7-Year warranty					
Axial High-Pressure Pump with 1-Year Warranty					
Auto Start/Stop					
Automatic Pressure Relief					
Downstream Detergent Injector					
Easy-Start Valve (265cc and above gasoline models only)					
Ground Fault Circuit Interrupter (1-phase electric models only)					
Heavy-Duty Roll Cage					
Wireless Remote					
Magnetic Start Switch					
Spring-Loaded Shock-Absorbing Feet					
Time Delay Shutdown					
Tubed Pneumatic Tires					
Flat Free Tires					

Standard Feature

Available Feature

\* Applies to specific models within series

PG	PC	HD Electric	PE	SEA	MPE	ZE	ZEF
							
Gasoline	Gasoline	Electric	Electric	Electric	Electric	Electric	Electric
						15° only	15° only
*			*		*		
Belt	✕ □ μ ρ ◆	Direct	Belt	Belt	Belt	Direct	Direct
*	*		*				**
*	*		*				

#

2-Gallon Pump Sprayer With Wand..... 79

A

A+ Surface Cleaner.....229  
 Ab 84 Cul..... 67  
 Accumulator - Pulse Dampener.....173  
 Accumulator By Interpump .....173  
 Adapters - Brass .....126  
 Adapters - Steel.....131  
 Adjustable Bronze Float Valves.....188  
 Adjustable Flow-Thru Thermostat.....224  
 Adjustable Foamer With Tank.....237  
 Adjustable Nozzle.....149  
 Adjustable Nozzle Holder.....109  
 Adjustable Nozzle Holder.....109  
 Adjustable Thermostat.....224  
 Adjustable Thermostat Switches..... 97  
 Adjustable Thermostat Switches For Landa Discharge Manifold..... 97  
 Admiral Pump Repair Kits.....160  
 Air King Pivoting High-Velocity.....262  
 Air Valve - Coil Blow Out.....194  
 Air-Driven Pump.....240  
 Air-Filter / Regulators .....240  
 Air-Operated Pump.....240  
 Air-Power Sprayers.....237  
 Allen Head Plugs.....130  
 Amazing Pocket Reference - Third Edition.....238  
 Ametek-Lamb Vacuum Motors .....243  
 Anti-Seize Compound.....174  
 Ap Dump Guns.....106  
 Ap Hose Reels.....121  
 Ap Trigger Gun.....103  
 Ap Unisulated Lances .....108  
 Ap Vacuum Motors.....242  
 Ap1000 Open Gun.....106  
 Aqua Master™ Model 440.....246  
 Aquatec 550 Series Diaphragm Pump.....253  
 Aquatec 550 Series Diaphragm Pump.....253  
 Ar Pump Kits.....171  
 Ar Pump Repair Kit Selection Chart.....170  
 Ar Triplex Ceramic Plunger Pumps.....169  
 Auto Wash ..... 73  
 Automatic Pressure Regulator.....178  
 Aviation Snips For Most Metals.....262

B

B 150 R Bp ..... 58  
 B 150 R Bp Accessories..... 59  
 B 40 C/W Bp ..... 50  
 B 40 C/W Bp Accessories..... 51  
 B 60 W Bp..... 52  
 B 60 W Bp Accessories..... 53  
 B 80 W Bp..... 54  
 B 80 W Bp Accessories..... 55  
 Backflow Preventor - Check Valve .....190  
 Baldor Motors - C-Face Open Drip Proof (Odp) .....198  
 Baldor Motors - Open Drip Proof (Odp) .....199  
 Ball Shut-Off Valve 1/4".....262  
 Ball Valve - 3 Way.....192  
 Ball Valves - Brass .....192  
 Ball Valves - Brass Mini.....191  
 Ball Valves - Compact Pvc.....192  
 Ball Valves - Forged-Brass.....191  
 Ball Valves - High-Pressure .....191  
 Ball Valves - Nickel-Plated Brass.....191  
 Ball Valves - Polypropylene.....192  
 Ball Valves - Pvc.....192  
 Ball Valves - Stainless-Steel.....191

Ball Valves - Stainless-Steel, One-Piece.....191  
 Ball Valves, Stainless-Steel, High-Pressure.....191  
 Banded Coupling .....133  
 Base Plates For Ignitors.....208  
 Bd 38/12 C Bp..... 48  
 Bd 50/50 C Bp..... 49  
 Bd 80/100 W Bp Classic .....56  
 Bd 80/100 W Bp Classic Accessories ..... 57  
 Bds 51/175 C..... 71  
 Beckett Misc Parts.....204  
 Beckett Misc Parts.....207  
 Big Guns .....105  
 Big Stainless-Steel Lances And Side Handles .....108  
 Black Pressure Switch.....215  
 Blower Wheel.....206  
 Blower Wheels.....207  
 Blue Top Filter.....136  
 Boot Hazmat / Flood.....269  
 Br 35/12 C Bp..... 47  
 Brass Bulkhead / Tank Fittings .....255  
 Brass Check Valves - Spring Loaded.....190  
 Brass Float Valve Assembly.....189  
 Brass Float, Ball And Stem .....189  
 Brass Pressure Regulator .....254  
 Breaker Switches .....224  
 Brick & Masonry Graffiti Remover..... 77  
 Briggs & Stratton Engine Parts.....197  
 Briggs & Stratton Engines - Gasoline.....197  
 Brushes.....236  
 Building Interior/Exterior Cleaner ..... 77  
 Bulkhead Fittings .....255  
 Burner Ignitors.....207  
 Burner Ignitors.....208  
 Burner Motors .....206  
 Burner Transformers.....208  
 Burner Transformers.....208  
 Bushings - Brass.....127  
 Bv 11/1 Hepa ..... 68

C

Cam Switch "Big Boot" 3-Position..... 222  
 Cam Switch And Box, 60 Amp On / Off..... 222  
 Car Wash Booms, "Reflex" .....240  
 Car Wash Vacuum Hose Cw150 And Cw200.....242  
 Carbon, Vapor Lock Filter.....260  
 Ceramic Plungers.....172  
 Ceramic Unitized Ball Valve .....104  
 Check / Foot Valve.....135  
 Check Hose Barbs .....129  
 Check Valves.....190  
 Check Valves - Swing Action .....190  
 Chem Injector .....185  
 Chemical Filter - Brass .....133  
 Chemical Injector - St-60 .....186  
 Chemical Injector - St-62 Variable .....186  
 Chemical Injectors - 400 Series .....187  
 Chemical Injectors - Robokim.....186  
 Chemical Injectors - Robokim Quick-Coupled .....186  
 Chemical Line With Filter.....133  
 Chemical Meter And Selection Valve - St-66.....193  
 Chemical Metering On-Off Valve .....193  
 Chemical Metering Valve - St-61.....186  
 Chemical Metering Valves .....193  
 Chemical Strainer - Plastic.....133  
 Chlorinated Degreaser..... 76  
 Chrome Ball Valve.....262  
 Circuit Breakers.....221  
 Cleancut Fuel Pump.....207  
 Cleaning Heads & Brushes..... 62  
 Cleaning Heads & Brushes..... 63  
 Cleaning Heads: B 40, 60, 80 W Bp And B 150 R Bp..... 60  
 Cleaning Heads: B 40, 60, 80 W Bp And B 150 R Bp..... 61  
 Clear Bowl Fuel Filter .....136



Clear Pvc Tubing .....117  
 Clear Reinforced Pvc Tubing .....116  
 Coil Descaler ..... 77  
 Coil Insulation ..... 98  
 Cold Water Lances.....88  
 Cold Weather Garden Hose .....116  
 Comet Pumps And Pump Kits.....171  
 Common Parts - Beckett & Wayne.....206  
 Compact Foamer.....237  
 Compact Pressure Switch .....215  
 Compact Thermal Relief Valves .....194  
 Compass™ Clean.....80  
 Compass™ Rinse.....80  
 Compass™ Shine.....80  
 Complete Pump Extraction Kit .....174  
 Complete Seal Kits.....157  
 Concrete Cleaner ..... 77  
 Concrete Remover.....75  
 Connector 1.5" - 2" Stainless-Steel.....263  
 Connector 1.5" - 2" Stainless-Steel.....263  
 Connector 2" Stainless-Steel .....263  
 Connector Hose - 2' - 10' .....117  
 Connector Hose - 2' - 10' .....118  
 Connector Hose - Car Wash Bay Hose - 12' - 25' .....118  
 Connector Hose / Car Wash Bay Hose, 12'-25' .....243  
 Connector: Barb Hose 1.5" - 1.5" .....263  
 Connector: Barb Hose 2" - 1.5" .....263  
 Connector: Barb Hose 2" - 2" .....263  
 Contactors And Relays .....250  
 Control Set "W" Series / Integrated Regulator / Unloader .....181  
 Controller And Contractor Tool - Genisys™ .....204  
 Copper And Plastic Float Balls .....189  
 Copper Fuel Dip Tubes ..... 97  
 Cord Caps / Plugs.....225  
 Cord Hugger 3 X 12.....265  
 Corrosion-Resistant Abs Gauge.....195  
 Coupler - Extended Twist Seal.....125  
 Coupler: 1/4" Female .....263  
 Coupler: 1/4" Female Stainless-Steel.....263  
 Coupler: 1/4" Female, Secure Lock.....263  
 Coupler: 1/4" Male Qc Econo .....263  
 Coupler: 1/4" Male Quick Connect Ph.....264  
 Coupler: 1/4" Male Stainless-Steel .....264  
 Coupler: Quick Connect 1/4" F Econo .....263  
 Couplers - Quick Connective .....124  
 Couplers - Twist Seal .....124  
 Couplers - Twist Seal .....124  
 Coxreels Hose Reels.....122  
 Crimp Fittings.....116  
 Cross - 4 Connects.....132  
 Cv 300.....69  
 Cyclone Rotary Flat Surface Cleaner .....231

**D**

D-Ring Handi Tie 1.5 .....265  
 Delavan Fuel Nozzles.....211  
 Delavan Fuel Nozzles - Continued.....212  
 Denali Series..... 20  
 Detail Components .....249  
 Detail Tool K-800 Psi Valve W-Whip Closed.....271  
 Diaphragm Check Valves - Nylon.....255  
 Diaphragm Float Valve.....189  
 Diaphragm Kits For Yamada Pumps .....239  
 Diaphragm Pump Units .....252  
 Digital Monitor .....224  
 Discharge Manifold / Rupture Disk.....96  
 Disposable Caution Sign.....271  
 Disposable Nitrile Gloves .....269  
 Double Hose Reel Stand.....267  
 Double Nozzle Head .....149  
 Double Shut-Off Couplers And Plugs .....125  
 Draft Diverters & Rain Caps.....210  
 Drain Cocks.....130

Dricapsol Cleaner (Rm 766).....78  
 Drum / Tank Pump, Crank Type .....236  
 Drum Pump .....268  
 Drum Pumps.....235  
 Drum Tool Accessories.....236  
 Dual Lances.....107  
 Dual Lances.....107  
 Dual Trigger Lance.....108  
 Dual-Chemical Systems.....235  
 Dual-Jet Wand .....271  
 Duckbill Snipping Shears .....261  
 Dump Gun .....106

**E**

Easy-Start Valve.....194  
 Easy-Start Valve.....195  
 Easy!Force Trigger Gun And Easy!Lock Accessory System .....84  
 Eaton Culter-Hammer Dp Connectors .....217  
 Eb 30/1 ..... 70  
 Ecos ..... 16  
 Ehw ..... 9  
 Elbow - Steel .....132  
 Elbows - 450 .....131  
 Elbows - 900 .....133  
 Elbows - 900 - Brass.....128  
 Electrode / Insulator Assembly.....204  
 Enclosure Box For Magnetic Motor Starter Sets .....220  
 Eng ..... 5  
 Eng ..... 6  
 Engine Parts - Kohler Lombardini.....197  
 Engines - Kohler Lombardini - Diesel .....197  
 Ergotec Safety Scraper 1.5" .....272  
 Erie Motortrol® Valve.....246  
 Extech Ph Meter Buffer Solution .....259  
 Extraction Cleaner & Pre-Spray (Rm 764).....79  
 Extraction Rinse (Rm 763) .....79  
 Extruded Or Forged Tees - Brass.....128  
 Ez Moves Hard Surface Pro .....262  
 Ez Moves Pro.....262

**F**

Faucet Kit Adapter .....266  
 Female Crosses - Brass Extruded.....128  
 Fiber Trapper Pre-Filter.....260  
 Fiberglass "Super Handles".....236  
 Fiberglass Telescoping Wands.....110  
 Field Attachable Couplings.....117  
 Filter - "The Big One" .....133  
 Filter And Parts - High-Volume.....136  
 Filters - Heavy-Duty In-Line .....134  
 Filters And Baskets.....247  
 Flanges .....175  
 Flanges .....175  
 Fleet Aluminum Brightener .....74  
 Fleet Degreaser .....74  
 Fleet Interior Tank Cleaner .....75  
 Fleet Machine And Heavy Equipment Degreaser .....75  
 Fleet Trailer Cleaner .....74  
 Fleet Wash Detergent.....74  
 Fleet Wash Solvent Detergent.....74  
 Flex Couplers .....175  
 Flex Couplers .....175  
 Flex Couplings.....204  
 Flex Lances .....110  
 Flex Lances.....241  
 Flex Line Bypass / Supply Line Hose .....117  
 Fliters - Clear Bowl .....134  
 Float Tank .....97  
 Flojet Diaphragm Pump.....252  
 Flow Control Metering Valve .....192  
 Flow Control Metering Valve .....193

# INDEX

Flow Meters.....	194
Flow Selector Valve.....	192
Flow Switch.....	214
Flow Switch.....	214
Flow Switch - Stainless Steel.....	214
Flow-Thru Gun.....	106
Flue Adapters.....	99
Foam Brush And Accessories.....	240
Foam Cannon.....	150
Foam Cannon.....	237
Foam Jet Kit.....	237
Foam Nozzle Attachment.....	257
Foot-Controlled Pressure Valve.....	235
Foster Double Shut-Off Quick Couplers.....	125
Fuel Conditioner And Soot Remover.....	207
Fuel Filter / Wash Separator.....	136
Fuel Filter / Water Separator.....	137
Fuel Filters.....	136
Fuel Oil Pressure Gauge.....	195
Fuel Pumps.....	207
Fuel Pumps.....	209
Fuel Solenoid Valve - 12V Dc Kip.....	208
Fuses.....	221
Fuses.....	241
Fuses.....	250

## G

Galvanized Pipe Fittings.....	133
Garden Hose - Apex Quality.....	115
Garden Hose Fittings.....	130
Gas Jets.....	209
Gas Pilots.....	211
Gas Regulators.....	210
Gas Valve Accessory Components.....	213
Gas Valves - 1" By Robert Shaw.....	210
Gas Valves - Lp Or Natural.....	213
Gear Reduction.....	174
Gear Reduction.....	174
Geared Reduction Units Interpump / General.....	175
General Fuel Filter Element.....	137
General Pump Tmt Flow Switch.....	214
General Purpose Cleaner.....	73
Genuine Interpump /General Pump Kits.....	167
Genuine Interpump /General Pump Kits Continued.....	168
Gfci Module.....	225
Giant Trigger Guns.....	103
Gloves - Industrial Duty.....	238
Goff's Curtain Walls.....	232
Grandi Brush.....	267
Grandi Brush (Head Only).....	267
Grandi Groom.....	267
Grandi Groom (Head Only).....	267
Grandi Groom Conversion.....	268
Ground Fault Circuit Interrupters (Gfci).....	226
Gum Blaster.....	271
Gum Remover Detergents.....	80
Gun Assembly - 910 Spot Spray.....	254
Gun Swivel.....	126
Gutter Cleaner Attachment.....	109

## H

Handi Brush.....	267
Handi Groom Brush.....	268
Handles.....	247
Hard-Surface Spinner Tool.....	258
Hd 7.9/72-4 Cage Ec.....	34
Hd Electric.....	27
Hd Gas.....	22
Hd Gas Skid.....	23
Hds Upright Class.....	4
Heating Elements And Thermostats.....	247

Heavy Duty Brown Degreaser.....	76
Heavy Duty Degreaser.....	76
Heavy Equipment Detergent.....	74
Heavy-Duty Swivels.....	254
Hepa Filter Pred 1200.....	260
Hex Coupling - Steel.....	131
Hex Couplings - Brass.....	127
Hex Couplings - Reducing - Brass.....	127
Hex Head Plugs.....	130
Hex Nipple - Steel.....	131
Hex Nipples - Double - Brass.....	127
Hex Pipe Plugs - Steel.....	132
Hex Reducing Nipples - Brass.....	127
Hex Socket Head Plugs.....	130
Hi-Lo Injector.....	186
Hide-A-Hose Swivel Cuff.....	264
High-Limit Switch.....	216
High-Limit Switch With Wire Lead.....	216
High-Pressure Check Valves.....	190
High-Pressure Nozzle Filters.....	148
Hl250 High / Low Variable Angle Nozzle.....	149
Hobby Gun, Lance And Hose.....	110
Hobby Hose.....	115
Honda Engine Parts.....	197
Hood And Duct Degreaser.....	76
Hose - 1-Wire.....	111
Hose - 2-Wire.....	111
Hose - A+ Hoses With Coupling And Plug.....	113
Hose - Legacy High-Pressure.....	111
Hose - Legacy Hoses With Coupling And Plug.....	113
Hose - Legacy Rawhide 2-Wire.....	112
Hose - Rawhide 1-Wire.....	112
Hose - Smooth Cover.....	112
Hose - Tuff -Flex - 1-Wire.....	114
Hose - Tuff -Flex - 2-Wire.....	113
Hose - Whitewater® Combination Steam Hose.....	114
Hose Barbs - Brass.....	129
Hose Bend Restrictors.....	115
Hose Clamps.....	131
Hose Cuff 1.5" - 2" Small End Threaded.....	264
Hose Cuff 2" - 1.5" Both Ends Threaded.....	264
Hose Cuff 2" Swivel Reducer.....	264
Hose Hook 1.5.....	264
Hose Hugger 3 X 27.....	265
Hose Hugger 3 X 34.....	265
Hot.....	3
Hot Water Generator.....	32
Hour Meters For Gasoline Engines.....	196
Hudson Float Valve.....	189
Hypro Roller Pumps.....	251

Icapsol Cleaner (Rm 768 Oa).....	78
Icapsol™ Encapsulating Chemical.....	80
Icapsol™ Encapsulator / Protector.....	80
In-Line Can-Type Filters And Parts.....	134
In-Line Clearview Filter.....	135
In-Line Filter - All Metal.....	134
In-Line Filter - Green-Cap.....	134
In-Line High-Pressure Nozzle Filters.....	135
Indicator Lights.....	224
Industrial Grease And Carbon Remover.....	76
Industrial Oil And Grease Remover.....	76
Injector - Adjustable Quick-Connect.....	188
Injector - Amerimax.....	185
Injector - St-64 Up Stream.....	186
Injectors - Brass.....	188
Insulated Lances.....	88
Insulation And Rigid Disc / Donuts.....	213
Interchangeable Orifice - Fits Nozzles Above.....	148
Interpump / General Pump Kit Selection Chart.....	166
Interpump / General Pumps.....	163
Interpump / General Pumps.....	164

Interpump / General Pumps .....	165
Interpump Packing Extractor Tool.....	173
Isolar 400/800 Solar Panel Cleaner .....	85
Isolar 400/800 Solar Panel Cleaner.....	86

## J

J.e. Adams Gun .....	103
Jarvis Hd Series .....	21
Jetter Pulse Valves.....	173
Jic Nipples - Brass.....	129
Jic Swivels.....	127
Jic X Pipe Nipples.....	128
Junction Boxes.....	220

## K

K Series Pressure Regulators .....	181
K Series Pressureregulators Kits .....	181
Kerick Float Valve.....	189
Keyed Ignition Switch - 12V Dc.....	198
Kip Solenoids.....	245
Km 70/20 C.....	36
Km 70/30 C Bp Adv .....	37
Km 75/40 W Bp.....	38
Kna Easy!Force Trigger Gun.....	88
Knee Pads.....	269

## L

Lafferty Airless Foam Kit.....	237
Lance Handles / Accessories.....	109
Lance Nozzle Couplers .....	147
Landa 1-Wire Hose .....	89
Landa 2-Wire Hose .....	89
Landa Burner Chart (Kna Burner).....	101
Landa Coils .....	98
Landa Cyclone Surface Cleaner.....	82
Landa Flow Switch .....	99
Landa Fuel Caps.....	97
Landa Fuel Tanks.....	97
Landa G3 Pump Repair Kit Selection Chart.....	95
Landa G3 Pump Repair Kits.....	94
Landa G3 Pumps.....	92
Landa G3 Pumps.....	93
Landa Gun .....	88
Landa High-Pressure Hose .....	89
Landa Hose Reels.....	90
Landa Industrial Sandblasters.....	87
Landa Pump Oil.....	96
Landa Pump Tool Kit.....	96
Landa Sand Nozzle.....	87
Landa Top & Bottom Wraps .....	98
Landa Unloader Valves.....	99
Landa Variable Pressure Lances.....	88
Landa Water Jet Surface Cleaner.....	82
Landafuel Filter / Water Separator .....	96
Legacy "Best" Spray Gun.....	103
Legacy "Industrial" Spray Gun.....	103
Legacy Air Mover (Lam3).....	261
Legacy Compact Foamer.....	150
Legacy Flow Switch .....	214
Legacy Flow Switch .....	214
Legacy Hd Pump Repair Kit Selection Chart.....	161
Legacy Hd Pumps - The Most Durable Pump On The Market .....	151
Legacy Hd Pumps - The Most Durable Pump On The Market.....	151
Legacy Hose Reel Swivels.....	120
Legacy Hose Reels.....	120
Legacy Industrial Gun & Lance.....	110
Legacy Oval Molded Grip Lances.....	107
Legacy Pump .....	156
Legacy Pump Repair Kit Selection Chart.....	158

Legacy Pump Repair Kits .....	159
Legacy Pump Repair Tool Kit.....	158
Legacy Pumps - Belt Drive Units .....	153
Legacy Pumps - Belt Drive Units .....	153
Legacy Pumps - Belt Drive Units .....	155
Legacy Pumps - Belt Drive Units .....	156
Legacy Pumps - Direct Drive Units .....	154
Legacy Pumps - Direct Drive Units .....	155
Legacy Pumps - Direct Drive Units .....	156
Legacy Pumps Continued - Belt Drive Units .....	152
Legacy Square Molded Grip Lances.....	107
Legacy Stackable Hose Reels.....	119
Legacy Superlite Stainless-Steel Dual Lance .....	106
Legacy Universal Unloader (Uu1).....	177
Legacy Vented Lances.....	108
Lid Supports.....	247
Liquid-Tight Strain Relief Connector For Cable, Wire And Tubing.....	225
Locks For Meter Boxes.....	241
Long Range Tip - 15 X 1 - Stainless-Steel .....	254
Low-Flow Brass Pressure Regulator.....	255
Low-Pressure Swivels.....	241
Low-Profile Wand, 4-Jet.....	271
Lp Conversion Kit For Robert Shaw .....	210

## M

M407 Trigger Gun .....	103
Machine Control Cam Switches, 3-Position .....	222
Magnetic Motor Starters.....	218
Male Branch Tees - Brass.....	128
Manual Motor Starter With Sealed Box.....	220
Mat Clamp.....	233
Maxshield Coveralls, Hood And Boots.....	270
Measuring Cups.....	249
Measuring Cups.....	268
Measuring Cups, 2 Oz.....	268
Medium-Pressure Swivels.....	241
Merchant Coupling .....	133
Metal Paint And Prep Phosphatizer.....	77
Metering Valve - Brass.....	193
Mg4000 Series Unloaders.....	184
Mhc .....	10
Mini Ball Valves.....	191
Misc Hose Cuffs And Accessories.....	264
Misc Replacement Parts.....	250
MI320 .....	105
Molded Power Cord .....	218
Mosmatic Gun Swivel .....	230
Mosmatic Roof Cleaner.....	231
Mosmatic Surface Cleaners And Duct Cleaner .....	230
Motors - A.o. Smith - Pressure Washer .....	200
Motors - Totally Enclosed Fan Cooled (Tefc).....	200
Motors - Weg - Pressure Washer .....	200
Motors - Weg - Pressure Washer .....	201
Mp .....	24
Mpe .....	30
Mv Lance Handle .....	109
Mv Triple-Function Nozzle .....	147
Mv925 Gun And Lance Combo.....	110
Mv925 Gun, Lance And Hose Combo .....	110
Mwp Recovery.....	35

## N

Nap Brush.....	267
Neutral Extraction Cleaner (Rm 767).....	79
Neutral Floor Cleaner .....	78
Nipples - Brass.....	127
Nitrile Flock-Lined Gloves.....	269
Nozzle - Dirt Killer Rotating.....	147
Nozzle - Duo-Reg .....	148
Nozzle - Multi-Fan .....	148
Nozzle - Mv Hi-Lo Turbo .....	147

# INDEX

Nozzle - Rotojet 2000 .....	148
Nozzle - Rotomax Rotating 3500 And 5800 Psi .....	147
Nozzle - Turbo .....	145
Nozzle - Variable Angle .....	149
Nozzle - Viper Rotating .....	147
Nozzle Accessories .....	208
Nozzle Fan Selection .....	138
Nozzle Kits - Legacy 4/Pk And 5/Pk Color-Coded Qc .....	139
Nozzle Kits - Legacy 4/Pk And 5/Pk Color-Coded Qc .....	139
Nozzle Protector / Coupler .....	150
Nozzle Sets - 4/Pk And 5/Pk Color-Coded Qc .....	140
Nozzle Size Selection Chart .....	138
Nozzles .....	249
Nozzles - Broad Spray Stainless-Steel .....	142
Nozzles - General Pump .....	140
Nozzles - Low-Pressure Applications, Brass .....	142
Nozzles - Spraying Systems .....	141
Nozzles - Spraying Systems .....	142
Nozzles - Suttner Turbo .....	146
Nt 25/1 Ap .....	40
Nt 30/1 Tact Te .....	41
Nt 30/1, 40/1, 50/1 Accessories .....	44
Nt 40/1 Tact Te .....	42
Nt 48/1 .....	45
Nt 50/1 Tact Te .....	43
Nt 68/1 .....	46
Nylon Pressure Regulator .....	255

## O

O-Ring Tool .....	173
O-Rings .....	123
Oil Burners .....	205
Oil Burners - 115V / 230V .....	203
Oil Burners - 14V Adc .....	204
Oil-Fired Hot Box .....	231
On / Off Cam Switch .....	224
On / Off Rotary Switch .....	219
On / Off Switch With Box "Elektra" .....	223
Open Guns .....	106
Orange 600 Sprayer Hose And Ribbed Pvc Sprayer Hose .....	116
Organic Vapor Respirator Set Cartridge .....	271
Orificed Hose Barb .....	130
Ozone Generator Villa 1000 .....	259

## P

Pa Float Valve .....	189
Pa Linear Gun .....	103
Pa Trigger Gun .....	105
Packing And Seal Kits .....	172
Packing Extractor .....	173
Padded Assist Handle .....	272
Parts And Accessories .....	81
Pc .....	26
Pdhw .....	13
Pe .....	28
Perfect Patch .....	262
Performance Tables .....	251
Pg .....	25
Pgdc .....	11
Pghw .....	12
Phoenix Flow Switch With Pilot .....	214
Phw .....	2
Pipe Nipple - Zinc .....	132
Pipe Street Elbows .....	133
Pipe Tees .....	133
Piston Pumps .....	172
Plastic Fittings .....	256
Plastic Protector Pads, 1000/Cs .....	269
Plunger Oil Seal Kits .....	157
Plunger Oil Seal Kits .....	157
Poly-Molded Sprayer .....	257

Powered Damper .....	211
Predator 1200 Portable Air Scrubber .....	260
Predator 600 Portable Air Scrubber .....	260
Premium Ball Shut-Off Valve .....	262
Pressure And Temperature Test Set .....	196
Pressure Gauges .....	195
Pressure Loop - 2-Wire .....	114
Pressure Reducer / Injector - Extact-A-Flow .....	188
Pressure Regulator .....	195
Pressure Switch .....	215
Pressure Washer Accessory Kit .....	110
Pressurized Drying System - 21 .....	261
Professional Sandblast Head .....	233
Profit From Power Washing .....	238
Propane Gas Hose .....	210
Propane Gas Regulators .....	210
Propane Tanks .....	210
Proportioners .....	246
Pto Geared Multiplier .....	175
Pulley Bushings .....	202
Pulleys .....	201
Pulleys .....	202
Pulsar Unloaders .....	179
Pulse Hose .....	115
Pump And Coil Protectant .....	77
Pump And Coil Protectant Concentrate .....	77
Pump Lube .....	174
Pump Lube .....	174
Pump Oil .....	174
Pump Parts And Tools .....	172
Pump Rails .....	157
Pump Technical Information .....	176
Pump Valve Kits .....	156
Pump Valve Kits Continued .....	162
Pumps And Pump Seals .....	249
Pumptech Pump .....	175
Push Button And Contact Blocks .....	217
Push-N-Lock Barbs .....	129
Puzzi™ 8/1 C .....	39
Pvc Check Valve .....	190
Quick Connective Couplers - Foster .....	123
Quick Couplers .....	123
Quick Couplers .....	124
Quick Couplers - Brass .....	125
Quick Couplersstainless-Steel .....	123
Quick Release Detergent .....	75
Quick-Coupled - Amerimax .....	185

## R

Racor Filter Funnel .....	137
Rain Suit, 2-Piece .....	238
Raintite Switch Box .....	221
Ready Pumps .....	93
Ready-Stack Hose Reels .....	91
Recovery Foam Blocker (Rm 761) .....	79
Red Carpet Enzyme Deodorizer .....	79
Red Carpet Extraction Cleaner .....	79
Red Carpet Liquid Defoamer .....	79
Red Carpet Odor Neutralizer .....	79
Red Carpet Pro Spotter .....	79
Red Carpet Super Conditioning Rinse .....	79
Red Carpet Super Pre-Spray .....	79
Red Carpet Wool & Natural Fiber Cleaner .....	79
Red Pressure Switch .....	215
Reducing Bushing - Steel .....	132
Reference / Calculation Guide .....	201
Regulating Relief Valve .....	185
Regulator - Vs 200 / 180 High-Volume .....	184
Regulator / Relief Valve - Vs 220 .....	185
Regulator / Relief Valve - Vs 350 .....	184
Regulator / Relief Valve - Vs 500 High-Pressure .....	184
Regulator / Unloader - Hm .....	182
Regulator / Unloader - Hm .....	182

Regulator / Unloader - St-261.....182  
 Regulator / Unloader - St-280.....183  
 Regulator / Unloader Vrs3.....178  
 Regulator Valve - Timex Pressure.....184  
 Regulators / Unloaders.....178  
 Regulators / Unloaders.....178  
 Relay Switch.....218  
 Relays.....219  
 Replacement / Repair Kits For Solenoids Valves.....245  
 Respirator, Full-Face.....270  
 Respirator, Half-Face, Large.....271  
 Rm 99 Solar Cleaner.....80  
 Rocker Switches.....223  
 Rollover Nozzle - Twist-Type.....149  
 Rollover Nozzle Head - St-56.....148  
 Romex Connectors (Metal).....225  
 Rosebud Nozzle Guard.....143  
 Rotary Switch, 8-Position.....241  
 Rotojet 3700 / Rotojet 5800.....145  
 Rotojet Soft - Hard Rotating Nozzle.....147  
 Rupture Disks.....194

**S**

S-Channel With Soft Squeegee.....273  
 Safety Glasses, Amber.....270  
 Safety Glasses, Clear.....270  
 Safety Pressure Relief Valve.....184  
 Salt And Ice Melt Remover.....75  
 Sandblast Hose.....87  
 Sandblast Kit, Carbide Nozzle Industrial Grade.....233  
 Sandblast Nozzle Tips.....233  
 Scraper Blades, 100 Blades / Pk.....272  
 Sea.....29  
 Seal Kits.....156  
 Seals And Gaskets.....247  
 Second-Stage Particulate Filter.....260  
 Self Serve Underbody Wand Assembly.....233  
 Series 505 Stainless-Steel.....188  
 Sewer / Tube Cleaning Nozzles.....150  
 Sewer / Tube Cleaning Nozzles.....234  
 Sewer Hose.....115  
 Sewer Hose.....235  
 Sg 4/4.....64  
 Sg1 C Bp Gum Remover.....66  
 Sgv 6/5.....65  
 Shipping Tape And Dispenser.....238  
 Shoe Covers, Blue.....269  
 Shoe Covers, White.....270  
 Shop Floor Cleaner.....78  
 Skimmer Components.....250  
 Slip-On Nozzle Protector.....149  
 Slt.....14  
 Slx.....15  
 Small Engine Test Equipment.....201  
 Smoke Tester - Diagnostic Tool.....208  
 Snap Fuel Nozzle Check Valve.....211  
 Snap N Lock Cuff.....265  
 Snap N Lock Cuff 2".....265  
 Soap Nozzles.....143  
 Soft-Edge And Hard-Edge Nozzle Protector.....143  
 Solenoid Valves.....244  
 Solenoid Valves.....244  
 Solenoids With Built-In Strainer.....245  
 Solution Hose 50', 1/4", 1500 Psi.....266  
 Solution Hose 50', 1/4", 3000 Psi.....265  
 Solution Hose 50', 3/8", 3000 Psi.....266  
 Solution Hose Live Swivel Assembly.....258  
 Solution Hose Reel.....265  
 Sonin 4-In-1 Multifunction Detector.....258  
 Sonin Digital Moisture Meter.....258  
 Sonin Moisture Test Meter.....259  
 Sonin Multi-Measure 45.....259  
 Speedmaster Throttle Control.....196

Splash-Proof Safety Glasses.....270  
 Spotting Bottle.....268  
 Spray-Flex™ Flex Wand.....109  
 Sprayer - Chemical-Resistant.....257  
 Spraymaster - High-Pressure.....257  
 Spraymaster - Standard.....257  
 Spraymax Trigger Gun.....253  
 Squeegee Soft Promo, 25 Pk.....273  
 Squeegee Soft, 10 Pk.....273  
 St-1500H Open Gun.....106  
 St-36 Pit Boss Sludge Sucker.....235  
 St-51N Adjustable Nozzle.....149  
 Stainless-Steel Bay Accessories.....241  
 Stainless-Steel Check Valves.....190  
 Stainless-Steel Industrial Sprayer.....257  
 Stainless-Steel Pressure Gauges.....195  
 Stainless-Steel Pressure Gauges.....196  
 Stainless-Steel Sewer Nozzles.....234  
 Stainless-Steel Sprayer.....257  
 Stair Wand 22" Straight.....272  
 Starter Solenoid - 12V Dc.....198  
 Stationary Hot Water Generator Series.....33  
 Steam Lance.....87  
 Steam Nozzle.....149  
 Steam Valve.....193  
 Steel Utility Gauges.....195  
 Stems Only.....188  
 Step-Down Transformers.....219  
 Street Elbow - Steel.....131  
 Street Elbows - Brass.....128  
 Street Tee - Steel.....132  
 Street Tees - Brass.....128  
 Styrofoam Blocks, Blue.....269  
 Styrofoam Blocks, White.....268  
 Suction Foot Valve - St35/35R.....135  
 Surface Cleaner Nozzle Recommendation.....231  
 Suttner Dual Lances.....108  
 Suttner Push And Pull Lance.....108  
 Suttner Trigger Gun.....105  
 Suttner Trigger Guns.....104  
 Suttner Trigger Guns.....104  
 Swivel Cuff: Big End Threaded.....264  
 Swivel Grout Brush.....267  
 Swivel Hose Barbs - Low Pressure.....129  
 Swivel-Head Ergonomic Stair Tool 30".....272  
 Swivels.....126  
 Swivels - 900.....125  
 Swivels - Ball Bearing.....126  
 Swivels - Right Angle.....125  
 Swivels - Stainless-Steel.....126  
 Swivels - Stainless-Steel Ball Bearing.....126  
 Swivels - Stainless-Steel, High-Pressure And Economy Brass.....126

**T**

T-Bar Ergotec®.....273  
 Tablet Extraction Cleaner (Rm 760).....78  
 Tablet Extraction Cleaner (Rm 760).....79  
 Tandem Hose Clamp.....265  
 Tank Screen / Strainer.....135  
 Tee - 3 Connects.....132  
 Teflon® Thread Sealing Tape.....237  
 Temperature Gauges.....196  
 Thermal Relief Valves.....193  
 Thermal Relief Valves.....194  
 Thermowell For Temperature Gauge Above.....196  
 Thread Lock Products.....238  
 Timer.....221  
 Timers And Switches.....248  
 Tip-Jet Nozzle System - Tips And Components.....143  
 Toggle / Push Button Switch.....215  
 Toggle Switch.....215  
 Tr Trailer.....18  
 Transformers.....241



## INDEX

Trapped Pressure Unloader Valves Vb10 / Vb9 .....	180
Trigger Valves .....	253
Trigger-Control Spray Lances .....	254
Trigger-Jet Spray Lances .....	254
Truck-Mount Hose, Heavy-Duty Blue .....	266
Truck-Mount Hose, Heavy-Duty Gray .....	266
Trv Thermal Relief Valves .....	194
Trv Trailer .....	19
Tule Series Trailer .....	17
Turbine Series Guns .....	253
Turbo A+ Nozzle Kit .....	144
Turbo Nozzle The Legacy Revolution .....	144
Turbo Nozzles .....	144
Turntable Drive Components .....	248
Twin-Diaphragm Spot Spray Pump .....	255

## U

Undercarriage Cleaner .....	231
Universal "Elektra" .....	222
Universal Spotter & Stain Remover (Rm 769) .....	78
Unloader - Ar Bolt-On .....	183
Unloader - Hypro-Style .....	182
Unloader - Yu - High Volume .....	182
Unloader Mounting Block .....	185
Unloaders - Gymatic .....	183
Unloaders - Pressure-Actuated .....	183
Unloaders - Pressure-Actuated .....	183
Unloaders - Pressure-Actuated .....	183
Upholstery Tool 4", Closed .....	272
Uv Flashlight Blaze 128 Led .....	258

## V

V-Belts - Super "Gripnotch" .....	202
V-Packing Insertion Tool Kit .....	173
Vac Switch - Burner Control .....	214
Vacuum Accessories .....	242
Vacuum Hose Reel .....	266
Valves - Honeywell Gas .....	209
Vb130 Regulator / Unloader .....	179
Vb200 / 150 High-Volume Unloader .....	179
Vb350 / 4 Unloader .....	180
Vb7 Regulator / Unloader .....	179
Vb75 / Vb135 .....	180
Vb80 / 400 Stainless-Steel Unloader .....	180
Vb85 / 820 Regulator / Unloader .....	179
Vba35 / Vb55 Unloader Valves For Legacy Hd Pumps .....	178
Vbt Unloader .....	177
Vehicle Pre-Soak .....	73
Vehicle Tire And Rim Cleaner .....	73
Vehicle Wash And Wax Detergent .....	73
Vehicle Wax .....	73
Vertical Float Tank Valve .....	189
Vhg .....	7
Vhp .....	8
Vinyl Disposable Gloves .....	269
Vinyl Electrical Tape .....	224
Vinyl Skid Covers .....	99
Vinyl Tubing .....	116
Vital Oxide .....	80
Voltage Regulator - Heavy-Duty 15V .....	198
Voltmaster Generator .....	223
Voltmeters .....	196
Vrt100 Unloader Valves .....	179

## W

Wall Buddy .....	268
Warehouse Floor Cleaner .....	78
Wash Gun - Rb65 .....	242

Water Broom 16" .....	234
Water Leveling System .....	249
Waterproof Exstik Ph Meter .....	258
Wayne Burner Chart .....	100
Wayne Burner Parts .....	206
Wayne Burners For Landa Pressure Washers .....	100
Whisper Wash Flat Surface Cleaners .....	229
Whisper Wash Flat Surface Cleaners, Continued .....	229
Whisper Wash Flat Surface Cleaners, Continued .....	230
Winco Ac Generator .....	223
Window Washing Bucket, 6 Gallon .....	272
Wire Loom, For Wiring Harnesses .....	225

## X

X-Jet Long Range Nozzle .....	109
Xt Overloads For Dp Contactors .....	217

## Y

Y-Trap Strainer .....	135
Yamada Pumps .....	239

## Z

Ze/Zef .....	31
Zinc-Plated Heavy Wall Steel Pipe Fittings .....	131
Zipwall 12' Poles, 2 Pk .....	261
Zipwall Carrier Bag .....	261
Zipwall Side Clamp, 2 Pk .....	261
Zipwall Zipper .....	261

# LANDA®

#LANDATOUGH



# PRESSURE WASHERS

## A MODEL TO FIT EVERY NEED

Combining the best in dependability and performance, whether you're cleaning indoors or out, there's a Landa to meet your needs.

- Industry-Leading Warranty
- Innovative Cool-Bypass Pump
- Efficient & Serviceable Horizontal Heating Coil
- ETL Safety Certified





# LANDA®



## Buy with Confidence!

Landa's advertised specifications (PSI, GPM, etc.) are certified by the Cleaning Equipment Trade Association to be correct. And, of course, nearly all Landa equipment are certified by Equipment Testing Laboratory (ETL) which verified we are in compliance with OSHA and CPSCA.



## Certification

Our manufacturing facilities have established and apply a Quality and Environmental Management System to be ISO 9001:2008 and ISO 14001:2004 certified.



[Landa.com](http://Landa.com)



[facebook.com/Landa.Karcher.Group](https://facebook.com/Landa.Karcher.Group)



[youtube.com/c/LandaTV](https://youtube.com/c/LandaTV)

© 2019 P/N 8.755-290.0